

OBTAIN

User manual

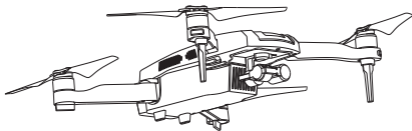

畅天游智能科技
C-FLY Intelligent Technology

Contents

Aircraft Diagram	4
OBTAIN Open way	5
Remote Controller Diagram	8
Remote Controller Operation	9
Gimbal Specification	10

Aircraft operate

Flight preparing	12
Return	15
Flight mode	16
Aircraft indicator light shown	18

Aircraft Diagram

OBTAIN is a foldable drone with stable camera, possessed flexible flying mode.

- Record 1080P video and take 500w Pixel picture, easily to capture complicated shot.
- The Maximum flight speed approach 43km/h.
- The Maximum flight time approach 26mins.

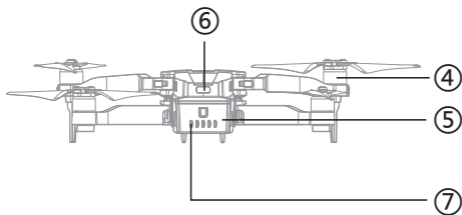
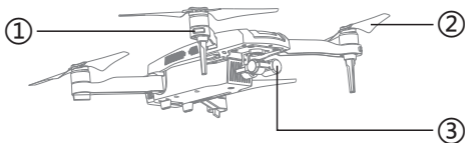

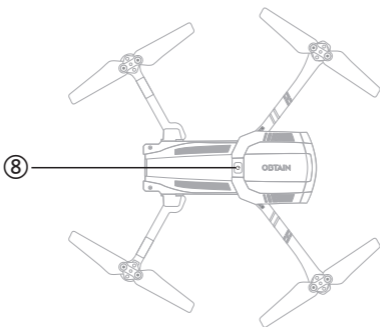

- 1. Drone head indicator light
- 4. Electric machinery
- 6. Drone status indicator light
- 8. Power Switch

- 2. Propeller
- 3. Gimbal
- 5. Intelligent Battery
- 7. Battery capacity light

OBTAIN Open way

All the arms of aircraft are fold on delivery, please open the arms as below.

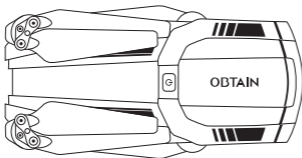

1. At first, please open the front arms, as below shown:

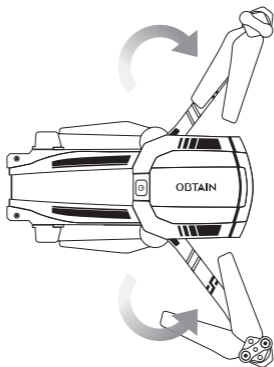

2. Second, Make the back arm vertical Straight down rotate 180°, then horizontal spread outside 60°.

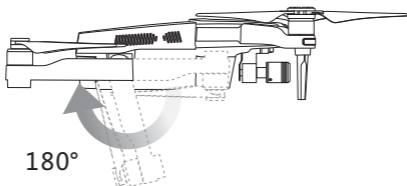

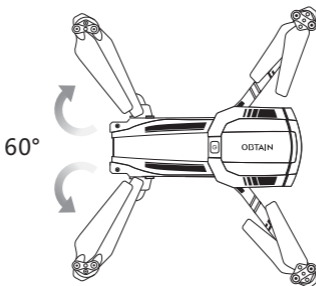

- ⚠ • Must open the front arms before you open the back arms.
- The back arm MUST open vertical Straight down rotate 180°, then horizontal spread outside 60°.

3.Spread Propeller

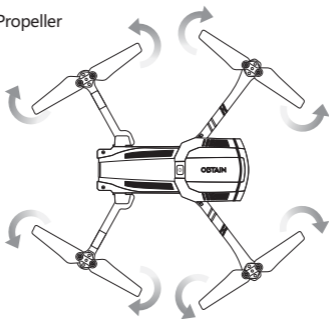

Please prepare aircraft by the above steps!!

Remote Controller Diagram

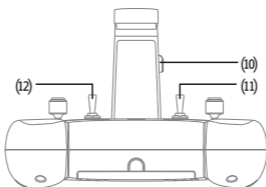
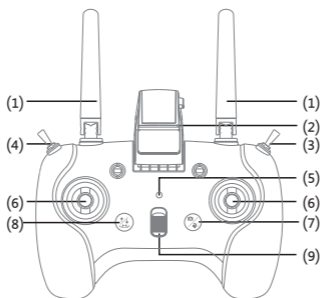

1. Antenna

2. Mobile phone Holder

3. Channel reservation

4. Switch of Flight Mode

5. Indicator light

6. Control stick

7. Switch of Picture/Video

8. Switch of Take off/Land

9. Power switch

10. Stretch Button of holder

11. Switch of Return

12. Switch of Follow Me

Remote Controller Operation

Open the smart phone Holder, and adjust the position of antenna, as picture shown.

- 1.Press the button beside mobile device support to extend
- 2.Adjust mobile device support to clamp mobile device
- 3.Connect mobile device and controller with Wifi

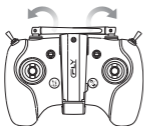

a.Expand the antenna outward

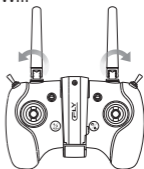

b.Rotating antenna

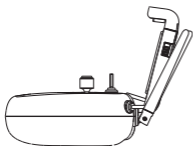

c.Adjust the antenna to 45° degrees with the remote control and expand the mobile device support

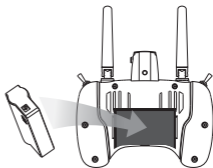

d.Put the battery into the back slot of the remote control with Positive and negative-grid current.



e.Put mobile device in mobile device support

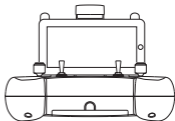

Gimbal Specification

Remove the gimbal cover and gimbal clamp from the camera.
as below:

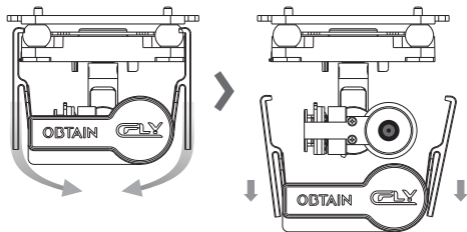

Gimbal Specification:

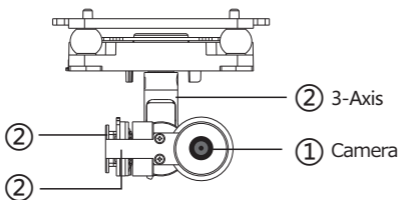

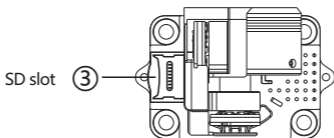

3-Axis gimbal can turn at three directions, make shot easier :

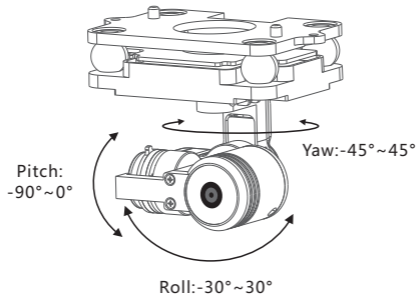

Do not remove the Micro SD card from the OBTAIN when it is turned on.

To ensure the stability of the camera system, single video recordings are capped at 30 minutes.

Aircraft operate

Flight preparing

1. Insert SD card to SD slot.

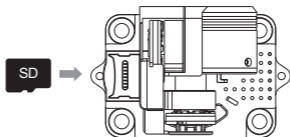

2. Make remote controller power switch on.

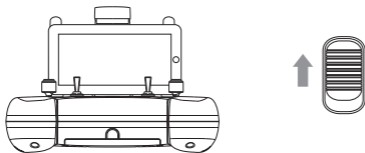

3. Insert battery to aircraft battery slot.

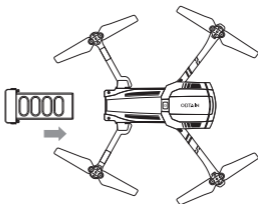

4.Put aircraft on the ground

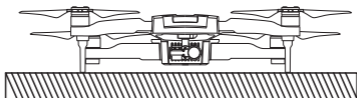

5.Short press once, and then long press 2s for turn off the drone.

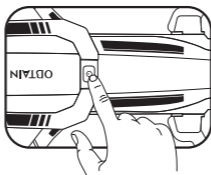

- Make sure capacity of battery is full when you use battery at very first time
 - Before flight, please make sure aircraft on the ground
 - Please leave aircraft immediately when you power aircraft on
-

5.when the green light on, Show it have GPS, Return Point was setting. You can fly it.At this moment, you can press one key take off /Land button for starting your wonderful fly time.



Or start as the following instruction.

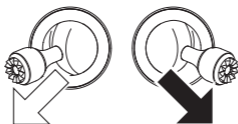

6. After the aircraft fly, you can control aircraft by controller stick.

a. P Mode, should be get GPS stable Signal, then you can fly your drone.

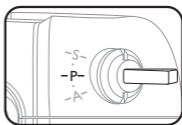

b. Control aircraft by controller stick.

Left joystick

Right joystick

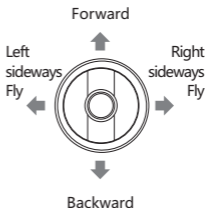
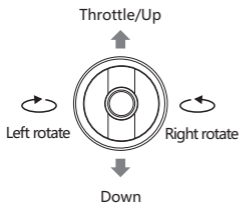

allocate throttle/up and forward at same time, the aircraft will fly forward very fast

Return

When the drone fly far away from you or unknown direction, you can press on "Return" switch, and wait for the drone come back to you. When the drone is falling, you can control the Pitch and Rudder-Aileron for safe land.

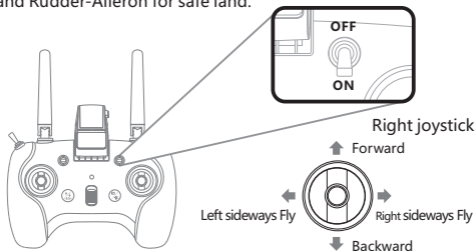

- When the drone out of control, It will automatic Return.
- When the drone in Low battery, It will automatic Return.

When the drone Landed, please wait until the propeller stop working, and then you can turn off the power of drone.(Short press once, and then long press 2s). Finally, Turn off the controller.

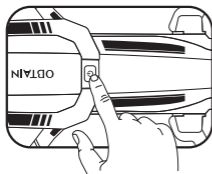

Power Switch of drone



Power Switch of Controller

Flight mode

S (Fly around the point) Mode : When choose S mode, the aircraft will fly around by itself, Press right joystick to backward and Widening circle radius, the aircraft will be surround 360 based on widening circle radius.Operation as below:

Operation as below:

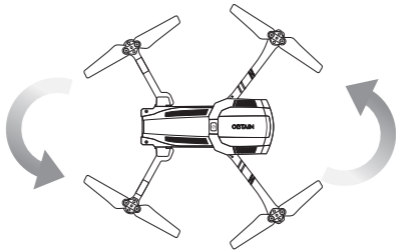
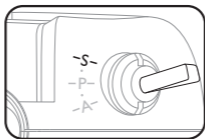

After selecting S mode, the drone rotates by itself.

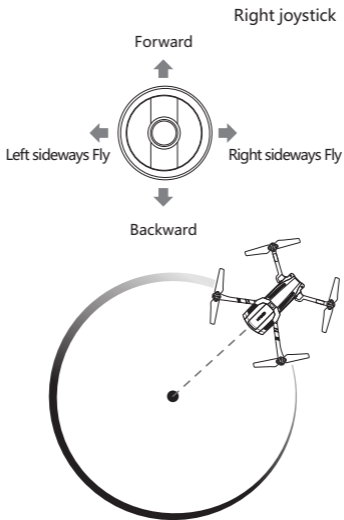

Through the Remote Controller operate the aircraft fly around the point.

P Mode(GPS Location) :When choose P mode, GPS signal will give the order to the aircraft, The aircraft will be automatic adjusted by the GPS Signal.

A Mode(Height Control) :When choose A mode, its Hand-Mode, you can control the aircraft for all kind of complicate flight by yourself.

Aircraft indicator light shown

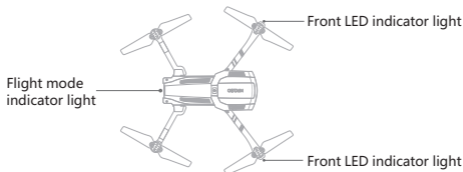

Aircraft indicator light shown: The Front LED light just show the direction of aircraft. The red light of aircraft will keep on when it power on. The Back LED Light show the flight status , please follow the below indication light status of flight.

Aircraft indicator light statement:

Normal		
Indicator status	Status description	
	Blue light keep on	System self-test
	Green light Keep on	GPS Location
	Green light flash	GPS haven't Location
	Green light double flash	USE Visual system Location
	Blue light double flash	Remote Controller connect
	Blue & red light flash alternately	Compass horizontal rotation calibration
	Red & green light flash alternately	Compass vertical rotation calibration
	Normal display when Calibration complete	
Warning!		
	Blue light flash	Without Remote controller signal
	Red light Keep on	Serious mistake
	Red light double flash	Serious low-voltage alarm
	Red light flash	Low-Voltage alarm
	Blue & green light flash alternately	Errors in compass data, Need to be calibrated

OBTAIN



www.cfly-cn.com