

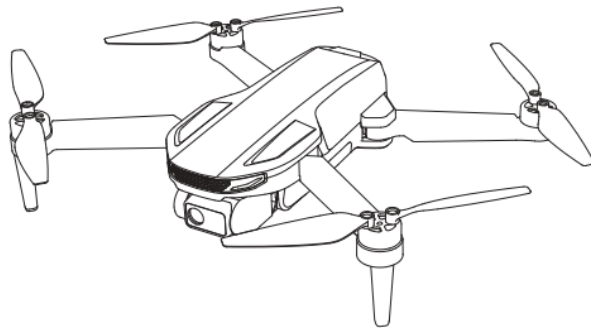

D65

User Manual
Gebrauchsanweisung

V 1.0



+1(334)336-0888

usa@deerc.com (USA)

eu@deerc.com (EU)

au@deerc.com (AU)

English

01-58

Deutsch

59-114

CONTENTS

1

Product Profile

- 01 Package Contents
- 02 Diagram of the Drone
- 03 Diagram of the Transmitter

3

Drone Functions

- 29 Flight Functions
- 36 Stabilization Functions
- 39 App Functions
- 49 Drone Status Indicator

2

Operation Guide

- 09 Charging
- 11 Pre-Flight Preparations
- 16 Pre-Flight Checklist
- 17 Flight

4

Appendix

- 50 Specifications
- 52 Contact Us
- 53 Troubleshooting
- 54 Compliance Information

Reading Guidance

Icon

“⚠️” essential precautions.

“💡” tips for operation and usage.

Recommended Steps

Our product offers both tutorial videos and the following resources:

- Disclaimer and Safety Guidelines
- Quick Start Guide
- User Manual

For a smooth start, we suggest watching the tutorial videos and reviewing the “Disclaimer and Safety Guidelines” first. Then, familiarize yourself with the basics through the “Quick Start Guide”. For a comprehensive understanding, delve into the “User Manual”.

Access Tutorial Videos

To ensure you're using the product safely and correctly, scan the QR code below to view our tutorial videos.



Download the Deerc GPS App

Simply scan the QR code below.



iOS



Android APP on Google play



Required Operating Systems: iOS 12.0 or later / Android 5.1 or later.

1.1 Package Contents >>

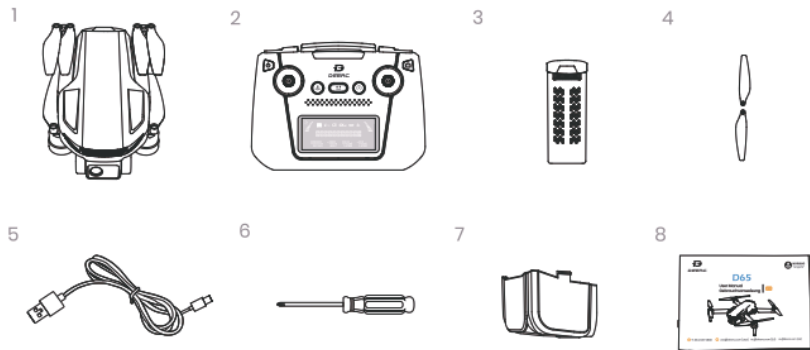

- 1** Drone
- 2** Transmitter
- 3** Drone Battery
- 4** Propellers
- 5** USB Charging Cable
- 6** Screwdriver
- 7** Gimbal Cover
- 8** User Manual

1.2 Diagram of the Drone >>

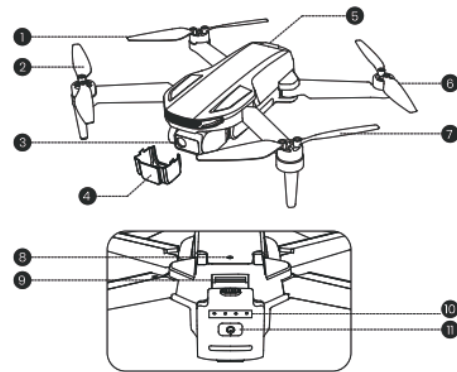

- 1** Propeller A
- 2** Propeller B
- 3** Gimbal and Camera
- 4** Gimbal Cover
- 5** Drone Battery
- 6** Propeller B
- 7** Propeller A
- 8** Optical Flow Positioning Lens
- 9** TF Card Slot
- 10** Battery Level Indicators
- 11** Power Switch

- 💡 · Turning on/off: Press and hold the power switch (🔌) for 3 seconds to turn the drone on/off.
- Battery level Indicators: To view the current battery level, short press the power switch once while the drone is powered off. If the battery level is too low, recharge before use.

1.3 Diagram of the Transmitter >>

The Transmitter

● Front:

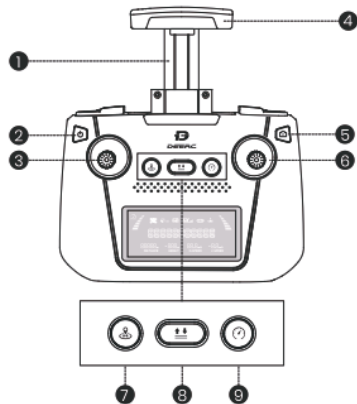

● Top:

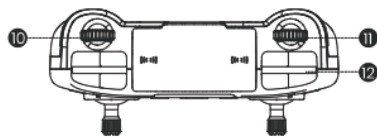

● Bottom:

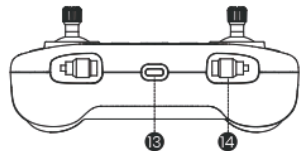

1 Phone Holder

3 Left Joystick

5 Take Photo: short press
Record Video: long press7 Return to Home: short press
GPS Switch: long press

9 Speed Switch: short press

11 Gimbal Dial

13 Charging Port

2 Power Switch: Short press, then hold

4 Antenna

6 Right Joystick

8 Takeoff/Landing: short press

10 Zoom in/out
(affects live view only, not final video)

12 Cellphone Slot

14 Storage Slots for Joysticks

- 💡 Press the Power switch (⏻) once to check the current battery level. If the battery level is too low, recharge before use.
- Turning on/off: Short press the power switch (⏻) once, then press and hold for 3 seconds to turn it on. Long press again to turn it off.

1.3 Diagram of the Transmitter >>

LCD Screen

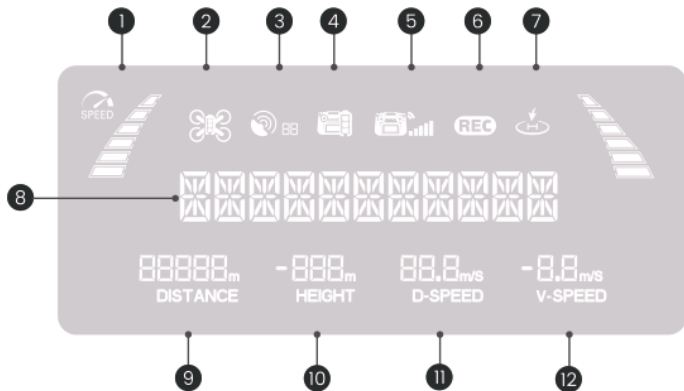





- | | |
|-------------------------------|-----------------------------|
| 1 Flight Speed | 2 Drone Battery Level |
| 3 GPS Signal Strength | 4 Transmitter Battery Level |
| 5 Transmitter Signal Strength | 6 Camera Status |
| 7 RTH Indicator | 8 Drone Status |
| 9 Flight Distance | 10 Flight Height |
| 11 Horizontal Speed | 12 Vertical Speed |

1.3 Diagram of the Transmitter >>

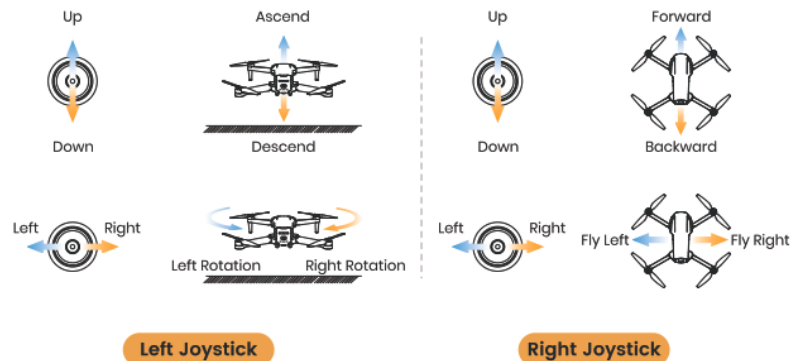
Joystick Mode

- **MODE 2:** (The default setting, i.e., left joystick as the throttle joystick.)



- **MODE 1:** Hold the  button, short press the  button once, then hold the latter until the transmitter beeps once (keep holding the  button throughout this process). You will see "R HAND MODE" displayed on the LCD screen, which means the transmitter is now in Mode 1.

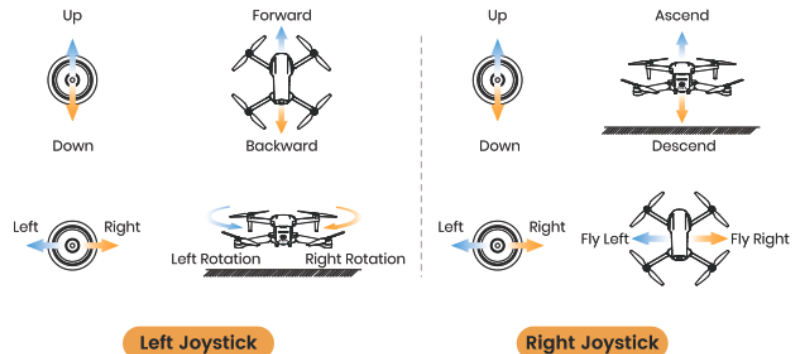

2.1 Charging >>

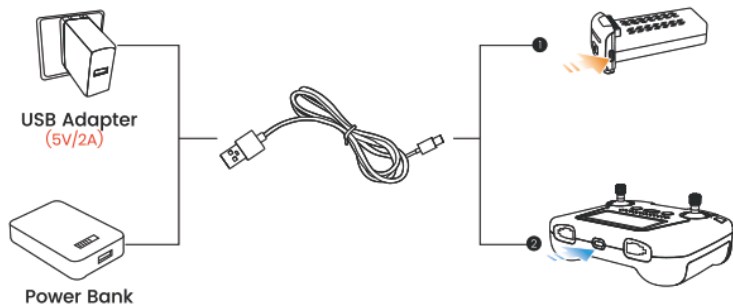

- ⚠** · Before charging, please read the instructions in the "Battery Safety" section of the "Disclaimer and Safety Guidelines" carefully!
- DO NOT charge the drone battery immediately after a flight as the temperature may be too high. Please wait until it cools down to room temperature before charging again.
 - Please use the original charging cable to charge the drone battery and transmitter.
 - The transmitter cannot be turned on while it is charging.

2.1 Charging >>

1 Charging of the Drone Battery:

- 1 Remove the battery from the drone and connect it to a USB charging cable.
- 2 Plug the USB charging cable into a USB charging port on a power bank or a USB adapter (5V/2A).
- 3 When the battery is charging, the battery level indicators **will keep flashing**. When it is fully charged, all the indicators **will be on**.
- 4 It takes about 120 minutes to fully charge a drone battery. A fully charged battery offers about 26 minutes of flight time.

2 Charging of the Transmitter:

- 1 Insert the USB charging cable into the charging port of the transmitter.
- 2 Plug the other end of the cable into a USB adapter (5V/2A) or power bank to start charging.
- 3 When charging, the LCD screen displays **"CHARGING."** When the charging is done, the LCD screen displays **"FULL BAT."**
- 4 It takes about 120 minutes to fully charge the transmitter. A fully charged transmitter offers about 8 hours of usage time.

2.2 Pre-Flight Preparations >>

Gimbal Cover

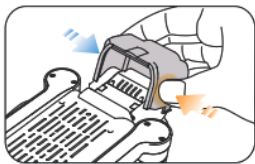

Turn the drone upside down and gently squeeze both sides of the gimbal cover to loosen the buckles. Then, carefully pull the cover outward to remove it.

Please remove the gimbal cover and the camera pad before turning on the drone.

Arms

- Unfold the **front** arms

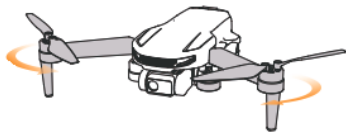

- Unfold the **rear** arms

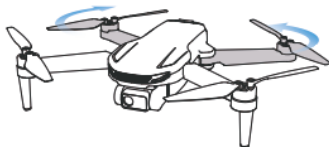

All arms of the drone are folded when it is packaged at the factory. First, unfold the front arms, then unfold the rear arms.

2.2 Pre-Flight Preparations >>

Propellers

- **Installation:**

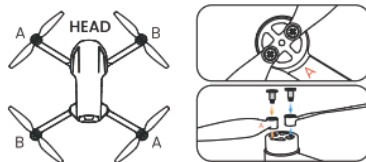

The drone will not fly unless the correct propeller is installed on the correct motor shaft. Each propeller is labeled with either an "A" or "B" on it. Secure the propeller onto the motor shaft using screws, turning each screw clockwise.

- **Removal:**

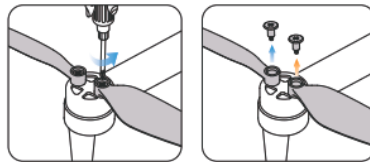

For propeller removal, use a screwdriver (provided) to rotate the screws counter-clockwise and remove the propellers. Be sure to hold the motor while detaching the propeller.

- Please check that the propellers are properly installed and tightened before each flight.
- Exercise caution when attaching/detaching the propellers to prevent any cuts or injuries.
- The propellers are installed before the drone is packaged at the factory.

2.2 Pre-Flight Preparations >>

TF Card

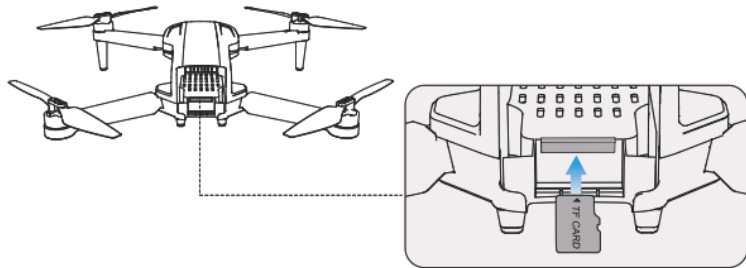

To store your photos and videos, insert a TF card (TF card not included) into the slot before inserting the battery into the drone. This drone supports TF card (Class 10 or above) with capacities up to and including **128GB**.

2.2 Pre-Flight Preparations >>

Drone Battery

● Installation:

*Before installing the battery, please check if it has a detachable insulation pad/band. If yes, remove it.

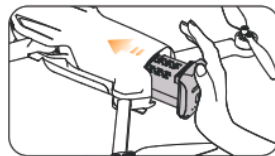

Push the battery correctly into the drone. Make sure that you hear a click sound, which indicates that the battery is firmly installed.

- 💡 · The battery should be installed firmly. Otherwise, the flight safety of your drone may be affected. The drone may crash due to a power-cut during the flight.
- Only install/remove the battery when it is powered off.

● Removal:

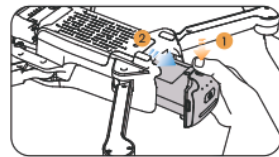

Press the lock button on the battery, and pull the battery out from the drone.

2.2 Pre-Flight Preparations >>

Joysticks

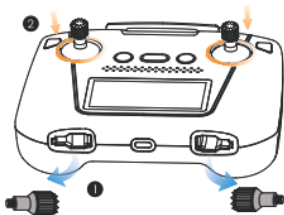

Take the joysticks out of the storage slot and mount them onto the transmitter.

Phone Holder

● Expandable Phone Holder

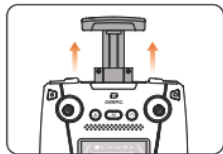

● Secure Mobile Phone

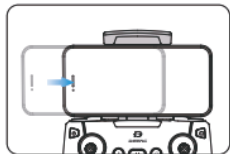

Expand the phone holder and place your mobile phone in it. Adjust the clamp to secure your mobile phone.

2.3 Pre-Flight Checklist >>

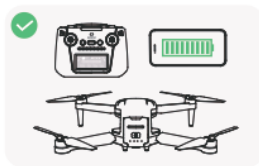

Make sure the transmitter, the mobile phone and the drone battery are fully charged.

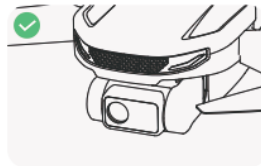

Make sure that the camera is clean.

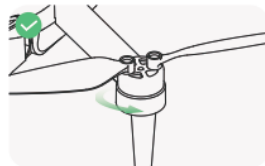

Make sure that there is nothing obstructing the motors.



Make sure the drone arms are unfolded.



Make sure the gimbal cover is removed before the flight.



Make sure you use accessories provided by this company.

2.4 Flight >>

Pairing

- All of the operations shown in this manual are demonstrated using MODE 2.
- Make sure that you go outdoor to an open area to operate the drone.

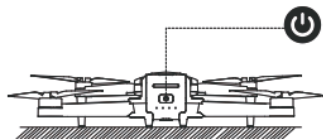

1 Turning on the drone:

Long press the power switch button () to turn on the drone. Place it on a level surface with its head pointing forward. The drone status indicator starts to blink. The drone will emit a power-on sound.

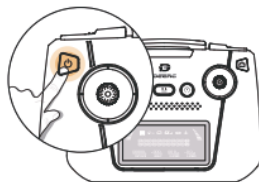

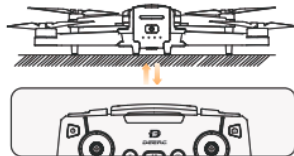

2 Turning on the Transmitter:

Short press the power switch () once, then hold it for 3 seconds to turn on the transmitter. The transmitter will beep once. The LCD screen displays "POWER ON".



3 Auto-pairing:

When the transmitter and the drone have successfully paired, the transmitter will beep once, and the drone indicators will become steady, the Transmitter Signal Strength () on the LCD screen is full and glowing.

-  **Gimbal Self-Check:** After pairing, the drone automatically checks the gimbal's components and functions for normal operation, lasting approximately **8 seconds**. During the self-check, the drone's indicators flashes, and upon completion, it remains steady.

2.4 Flight >>

Wi-Fi Connection

 Make sure the pairing has finished before going to the Wi-Fi settings on your phone.



- 1 Go to the Wi-Fi settings on your phone.
- 2 Connect to the drone's Wi-Fi network: **DeercFPV-*******.
- 3 Run the **Deerc GPS** app. A successful connection is confirmed when the drone's live video feed is displayed within the app interface.



- Connecting your phone to the drone's Wi-Fi may take some time. Please remain patient and wait for the connection to be established successfully.
- For optimal connectivity, if you're experiencing issues with the WIFI connection or the image transmission in the APP isn't displaying, it's advised to disable your phone's Bluetooth, Mobile Data, and VPN. Alternatively, switch your phone to airplane mode and attempt to reconnect.
- Please ensure that all permissions requested by the app are granted.



The Wi-Fi network created by the drone does not have internet access. As a result, your cellphone might:

- Notify you that the connection isn't secure,
 - Indicate there's no internet connection, or
 - Suggest switching to cellular data.
- (The exact wording may vary based on cellphone models.)

Please disregard these messages. If prompted, select the option to remain connected to the current Wi-Fi.

2.4 Flight >>

Compass Calibration



- **Step 1:**

Push both joysticks to the upper, inner corners to enter compass calibration. The transmitter will beep once, indicating that the calibration has started. You can now proceed with Step 2.



- **Step 2:**

Keep the drone parallel to the floor, and spin the drone three times till the transmitter beeps once. Then proceed with step 3



- **Step 3:**

Point the head of the drone upward, and spin the drone three times till the transmitter emits a double beep, which means that you have successfully performed a compass calibration.



- To ensure a stable flight, we recommend that pilots perform a compass calibration before each flight.
- We recommend that the pilot hold the drone approximately 3 ft above the ground while performing the compass calibration.
- DO NOT calibrate the compass in locations where magnetic interference may occur, such as close to magnetite deposits or large metallic structures such as parking structures, steel reinforced basements, bridges, cars, or scaffolding.
- DO NOT carry objects (such as mobile phones) that contain ferromagnetic materials near the drone during calibration.

2.4 Flight >>

GPS Signal Search

💡 Please don't use the GPS mode when you are indoors.

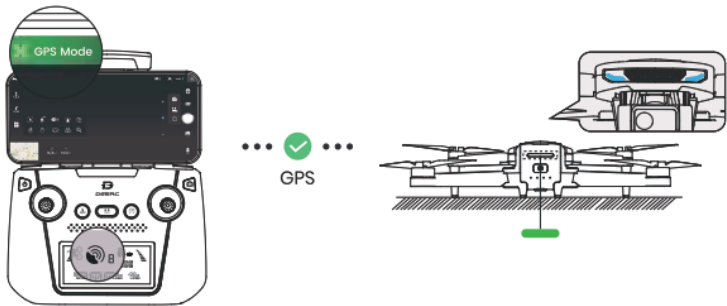

After calibrating the compass, put the drone on a flat surface. Make sure there are no external sources of signal interference around.

The drone will automatically perform a search for GPS signals. The drone has successfully located the GPS signal when its front indicator turns solid blue and its rear indicator turns solid green. The satellite connection count shown by the GPS signal icon (📶) on the LCD Screen is "8" or higher.



A solid blue front indicator and a solid red rear indicator signify that the GPS search is still in progress.

- If the GPS signal is weak or if you plan to fly the drone indoors, you may notice the front indicator showing solid blue and the rear indicator displaying solid red. If you want it to take off, you can hold the 📶 on the transmitter for 2 seconds to exit the GPS mode. The LCD screen displays "ATTI MODE," the drone goes into attitude mode, it can take off. However, please note that all GPS-related functions will be unavailable now.

2.4 Flight >>

Gyro-Calibration

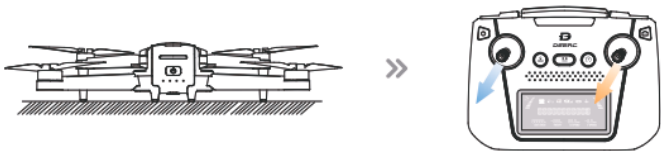

Make sure to place the drone on a level surface before calibrating the gyro. Simultaneously push the left joystick and the right joystick to the bottom left corner to calibrate the gyro. The indicator lights on the drone will blink, then turn solid, which indicates that the calibration is completed.

 Gyro calibration is required only after a collision or accident to ensure flight stability.

2.4 Flight >>

Unlocking the Motors

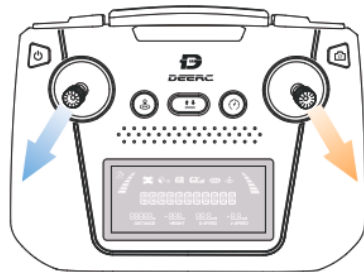

Push the joysticks to the outer lower corners. The motors start to spin, the drone is unlocked.

 Locking the motors: Repeat the action above to lock the motors.

2.4 Flight >>

Takeoff/Landing

💡 Remember to unlock the motors before takeoff.

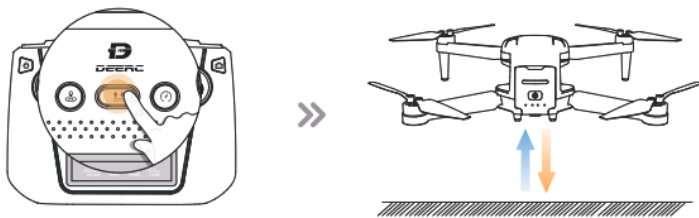

Takeoff Short press the \updownarrow button, the drone will take off automatically and hover at 5 ft. Now you can control the drone by using the joysticks.

Landing During the flight, short press the \updownarrow button, the drone will land on the ground automatically.

💡 When operating the drone, it's important to periodically adjust the orientation and distance between the transmitter and the drone to ensure that the drone always remains within the optimal communication range.

Optimal Reception Range:



Weaker Signal:

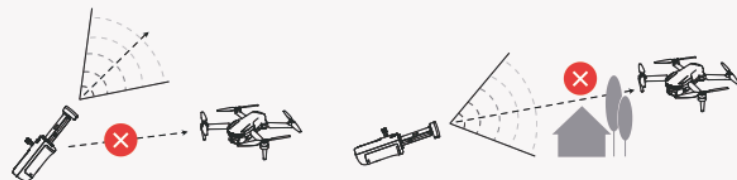

3.1 Flight Functions >>

Zoom

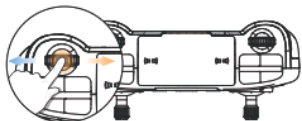

To zoom in, scroll the zoom dial ⊕ to the right; To zoom out, scroll the zoom dial ⊖ to the left.

Gimbal Dial





The gimbal provides a steady platform for the attached camera, allowing you to capture clear, stable images and video. The control tilt range is -70° to 0° . Use the gimbal dial on the transmitter to control the tilt of the camera.

3.1 Flight Functions >>

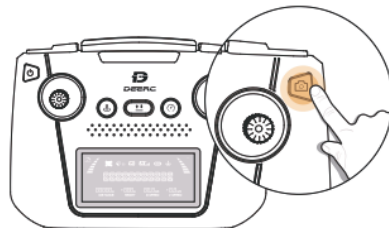
Take Photo/Record Video



- 1 Short press the () button on the transmitter. The (**REC**) on the LCD screen flashes once, which means that you have successfully taken a photo.
- 2 Long press the () button on the transmitter. The (**REC**) on the LCD screen starts to blink, which means the camera is recording. Long press the button again will stop video recording.

3.1 Flight Functions >>

Speed Switch

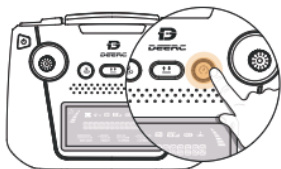

This drone offers three speed modes: Low, Middle and High. Short press the (🔄) button once to switch speed. By default, it's set to Low speed.

• Low:



The transmitter beeps once.
The LCD screen displays
"CAMERA MODE" (🚁).

• Middle:



The transmitter beeps twice.
The LCD screen displays
"NORMAL MODE" (🚁).

• High:



The transmitter beeps 3 times.
The LCD screen displays
"SPORT MODE" (🚁).

3.1 Flight Functions >>

Return to Home(RTH)

- The Return to Home (RTH) function brings the drone back to the recorded Home Point. This function can only be triggered when the drone is in GPS mode.
- The drone's default home point is the location where it first receives a strong GPS signal (When this occurs, the satellite connection count shown by the GPS signal icon (📶) on the LCD Screen is "8" or higher). The drone will record its takeoff position at that moment as the home point. During flight, if the drone lands at a new location, the position of the next takeoff will become the newly recorded home point.

* **RA: the Return Altitude set in the app setting. (The default RA is 66 ft.)**

1 Smart RTH:

When the GPS signal is strong (satellite connections ≥ 8) and the Home point is recorded previously, press the (📍) button. The LCD screen displays **"RTH MODE"**, indicating that the Smart RTH is activated. The drone will start flying back to the Home Point automatically.

During the RTH procedure, if the pilot presses the (📍) button, the LCD screen displays **"EXIT RTH"**, the drone will exit the RTH procedure immediately.

2 Failsafe RTH:

The Failsafe RTH will be activated when:

3.1 Flight Functions >>

Return to Home(RTH)

1. The drone receives a strong GPS signal (satellite connections ≥ 8); and
2. There is a pre-recorded Home Point; and
3. The connection between the transmitter and the drone is lost for more than 6 seconds.
4. The compass has no interference.

Once the Failsafe RTH is activated, the drone will start to fly back to the pre-recorded Home Point automatically. If the connection between the drone and the transmitter is re-established during the Failsafe RTH procedure, you can exit the RTH manually.

 The following are two possible returning procedures for Smart RTH and Failsafe RTH:

- ④ **Flight altitude $\geq RA$:** When the drone's current altitude is higher than or equal to RA, the drone will maintain its current altitude, fly back above the Home Point, then descend to the ground.
- ④ **Flight altitude $< RA$:** When the drone's current altitude is lower than RA, the drone will first ascend to RA, fly back above the Home Point, then descend to the ground.

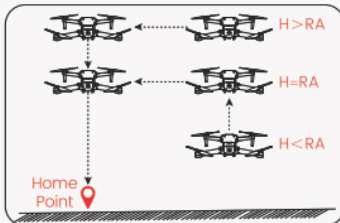

③ Low Voltage RTH:

When the flight battery is too low or there is not enough power to return home, the user should land the drone as soon as possible to avoid damage to the drone or other hazards. To prevent unnecessary risks due to insufficient battery power, the low voltage RTH function will be automatically triggered when the drone battery is low. According to the remaining power, there are two scenarios:

The First Stage of Low Voltage RTH: The drone will return to a border 66 ft in height and 98 ft in distance away from the Home Point. While the drone is returning, the LCD screen displays "RTH MODE".

After the drone returns, you will be restricted to flying it within a 'safety zone,' which is centered around the Home Point and has a radius of 98 ft and a height of 66 ft. The drone will not be able to exit this zone.

* Please note, if the drone is already flying within the safety zone before the battery level drops to the threshold for activating Low Voltage RTH, then the First Stage of Low Voltage RTH will not be executed.

3.1 Flight Functions >>

Return to Home(RTH)

The Second Stage of Low Voltage RTH: The drone will automatically return to the Home Point. While the drone is returning, the drone indicators are flashing red quickly.

* Please note, when the flight distance is within 16 ft, the drone will just land on the ground directly.

- ⚠ · During the RTH procedure, the drone can NOT avoid obstacles.
- If the GPS signal is weak or unavailable, the RTH cannot be activated.

3.2 Stabilization Functions >>

Altitude-Hold Function

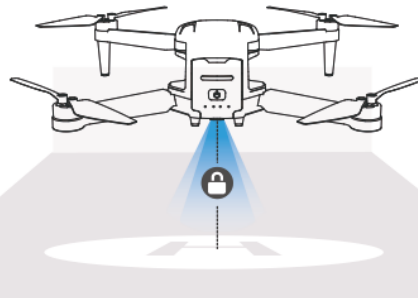

The drone is designed with an altitude-hold function to maintain its altitude after releasing the left joystick. (The left joystick will automatically spring back to the middle)

3.2 Stabilization Functions >>

Optical Flow Positioning

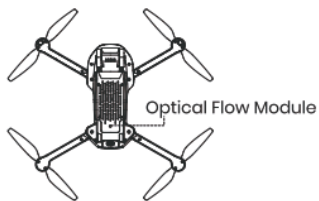

The Optical Flow Positioning System consists of a camera module, which acquires the position information of the drone through visual images to ensure precise positioning of the drone.

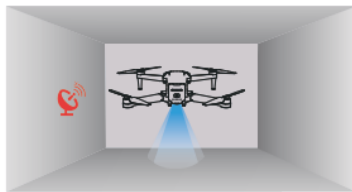

The Optical Flow Positioning System is typically used in an indoor environment when the GPS signal is weak or unavailable. The optimal usage height for Optical Flow Mode is **1.6-9.8 ft**.

⚠ - The precision of the Optical Flow Positioning System is easily affected by the light intensity and features of the surface textures. Once the image sensor is not available, your drone will switch on the altitude-hold function automatically. Please exercise utmost caution when operating the drone under these circumstances:

- Fly over surfaces without clear patterns or textures.
 - Fly over extremely dark or bright surfaces.
 - Fly in an area where the lighting changes dramatically and frequently.
 - Fly over moving surfaces or objects. (e.g., above crowds, above bushes or grasses swayed by strong winds).
 - Fly over water or transparent surfaces.
 - Fly over highly light reflective surfaces. (e.g., mirrors).
 - Fly over monochrome surfaces (e.g., pure black, red, or green).
 - Flying over surfaces with repeating identical patterns or textures (e.g., tiles with the same design).
 - Flying speed should be controlled not to be too fast.
- Keep sensors clean at all times.
 - DO NOT scratch or tamper with the sensors. DO NOT use the aircraft in dusty or humid environments.
 - Make sure that the light is bright enough and the surface is with clear textures so that the Optical Flow Positioning can acquire the movement information through recognizing the ground textures.

3.3 APP Functions >>



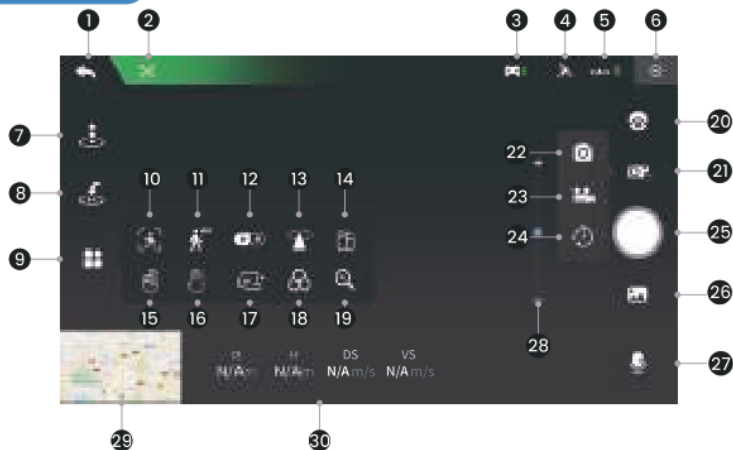





APP Interface











- 1 Back (↩): Tap this icon to return to the main menu.
- 2 System Status (📶): Displays the flight status and various warning messages.
- 3 Transmitter Battery Level (🔋): Real-time display of the current battery level of the transmitter.
- 4 GPS Signal Strength (📶): Displays current GPS signal strength.
- 5 Drone Battery Level (🔋): Real-time display of the current battery level of the drone.
- 6 Settings (⚙): Tap to enter the setting interface. Alter settings for flight height/distance, return altitude, etc.
- 7 One Key Takeoff/Landing (🚀): Tap the icon, follow the instructions in the prompt box to takeoff/land.
- 8 Return to Home (🏠): The drone returns to the last recorded Home Point.
- 9 Multi-functions (📦)
- 10 Image Follow (👤): After selecting a target, the camera will always point towards it no matter how the target moves. The position of the drone in the air remains unchanged. (The target should not move too fast.)
- 11 GPS Follow (👤): The drone stays at a distance from the operator and follows the GPS position of the paired mobile phone.

3.3 APP Functions >>

APP Interface

- 12 VR Mode(): Pair the mobile phone with a pair of VR glasses (not included) first. Then use this function to watch 3D live feed in real-time.
- 13 Point of Interest (): The drone flies around a point.
- 14 Portrait (): The shooting mode will turn from landscape to portrait.
- 15 Gesture Selfie (): When in this mode, you can trigger the shutter of the drone camera by holding a "V"-sign near your face. (The drone camera should be pointing to your face.)
- 16 Gesture Selfie video (): When in this mode, you can trigger the shutter of the drone camera by holding your outstretched palm near your face. (The drone camera should be pointing to your face.)
- 17 TapFly(): The drone flies along the flight path you draw on the screen of the mobile phone.
- 18 Camera Filter ()
- 19 Zoom (): Tap to zoom in/out.
- 20 Gimbal Adjustment (): Tap to access and configure gimbal parameters. (Adjustments are only allowed before the drone takes off.)

- 21 Shooting Modes ()
- 22 Take Photo (): Tap to use the photo function.
- 23 Record Video (): Tap to use the record function.
- 24 Time-lapse (): Tap to use time-lapse shooting .
- 25 Shutter Button ()
- 26 Gallery (): Tap to preview photos and videos taken by the drone camera.
- 27 Audio Recording (): Record sounds and voices with your mobile phone while shooting videos.
- 28 Camera Angle Adjustment: Slide up and down to adjust the camera angle.
- 29 Map (): Tap the Mini Map to switch between Camera View and Map View.
- 30 Flight Parameters:
 - Flight Altitude ($\frac{H}{N/A_m}$): Vertical distance from the Home Point.
 - Flight Distance ($\frac{D}{N/A_m}$): Horizontal distance from the Home Point.
 - Horizontal Speed ($\frac{DS}{N/A_{m/s}}$): Drone's speed in the horizontal direction.
 - Vertical Speed ($\frac{VS}{N/A_{m/s}}$): Drone's speed in the vertical direction.

3.3 APP Functions >>

Beginner Mode

It's recommended that beginner pilots first familiarize themselves with the drone by using beginner mode. In Beginner mode, which is the default operating mode, the following settings apply:

- 1 Flight Distance is capped between 0-98 ft.
- 2 Flight Height is restricted to a range of 0-98 ft.
- 3 RTH Altitude is set to 65 ft by default.

To alter the settings mentioned above, you'll need to turn off beginner mode first.



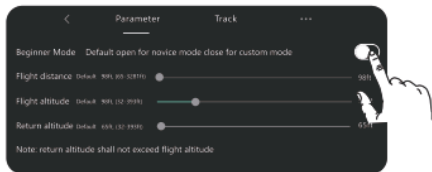

Flight Settings
On APP

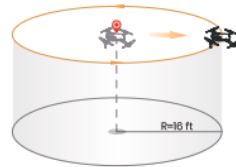
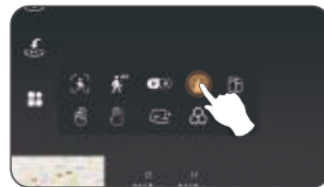

3.3 APP Functions >>

Point of Interest





- 1 Tap the  icon first, then select the  icon, and follow the prompt box to activate the Point of Interest function. You can set the circling radius in the prompt box.
- 2 The moment you activate this function, the drone will record its current flight position as the "point of interest". It will then continuously circle around that point clockwise. (default radius: 16 ft)
- 3 To exit Point of Interest mode, simply tap the  icon again.

3.3 APP Functions >>

GPS Follow

When the GPS Follow function is enabled, the drone will track your movement by following the GPS signal on your cellphone. (Please make sure that the connection between the drone and the transmitter is strong and stable.)



- 1 Make sure that the drone's flight distance is within 164 ft. Tap the  icon first, then select the  icon.
- 2 Follow the prompt box to enter the GPS Follow function – the drone will now follow your cellphone's coordinates.
- 3 To exit GPS Follow function, simply tap the  icon on the app interface again.



- ⚠ · The GPS Follow function can only be used if the flight distance is within 164 ft.
- Please use this function in an open area and be mindful of your surroundings. The drone is NOT equipped with obstacle avoidance.
- Follow Me function may be difficult to activate if the mobile phone's GPS signal is too weak. This could be caused by signal interference from surrounding buildings, trees, mobile network congestion etc.

3.3 APP Functions >>

Tapfly

Before using TapFly, pre-load the map by connecting your phone to the internet and tapping the map icon; auto-loading occurs. Enlarging the map for TapFly is advised.







- 1 Tap the  icon, then Tap .
- 2 You can tap a dozen of times (but no more than 16) on the phone screen to create a flight path. Hit "GO" to submit the route. The drone will then fly along the path created by connecting the points you tap in order.
- 3 You can exit TapFly by tapping the  icon again, or pushing the right joystick in any direction.

 DO NOT fly the drone towards people, animals, or small/thin objects (e.g. tree branches and power lines) or transparent objects (e.g. glass or water).

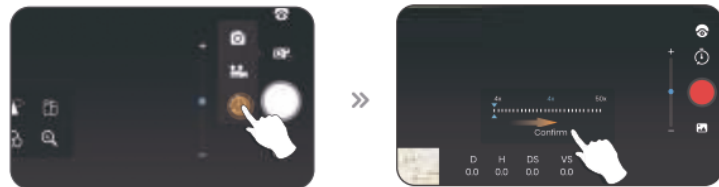





3.3 APP Functions >>

Time-lapse



- 1 Tap the  icon, then tap  to use time-lapse shooting.
- 2 Swipe to choose the video playback speed, tap again to confirm.
- 3 Tap the shutter , the time-lapse shooting begins.
- 4 Tap the shutter  again to stop recording.

3.4 Drone Status Indicator >>

Indicator Status	Meanings
 Front Blue, Rear Red, Flashing, Rapidly	Unsuccessful pairing after powering on the drone.
 Front Blue, Rear Red, Solid	Searching for GPS signals/Successfully exited GPS mode.
 Front Blue, Rear Green, Solid	GPS signal search successful.
 Front Blue, Rear Red, Flashing Slowly	Entered first stage of Low Voltage RTH.
 Front Blue, Rear Red, Flashing Rapidly	Entered second stage of Low Voltage RTH.
 Front Solid Blue, Rear Alternating Between Green and Red.	Compass Error
 Front and Rear Flash Alternately: Front Blue, Rear Red	Lost Connection/Satellite Signal Lost

4.1 Specifications >>

• DRONE:

Model: D65	Weight: 246g/8.7oz
Max Flight Time: 26 minutes <small>(in a windless environment)</small>	Max Flight Height: 394 ft/120m
Max Wind Speed Resistance: 5.5m/s	Max Takeoff Altitude: 9842 ft/3000m
Operating Temperature Range: 32° to 104°F (0° to 40°C)	
Size: 296*208*53 mm (unfolded)	147*85*53 mm (folded)

• DRONE BATTERY:

Capacity: 1820mAh	Voltage: 7.7V
Battery Type: Lithium-ion Polymer Battery	Energy: 14.014Wh
Charging Temperature Range: 41° to 104°F (5° to 40°C)	
Charging Time: About 120 minutes	

4.1 Specifications >>

• CAMERA:

Operating Frequency: 5500–5700MHz	Max Transmission Distance: 2625 ft/800m <small>(outdoor and unobstructed)</small>
Photo Resolution: 3840×2160P <small>(when stored in TF card)</small>	3840×2160P <small>(when stored in cellphone)</small>
Video Resolution: 2560×1440P@30fps <small>(when stored in TF card)</small>	1280×720P@30fps <small>(when stored in cellphone)</small>
Lens: FOV:100°	Photo Formats: JPEG/JPG
Video Formats: MP4	Supported File Systems: FAT32
Supported TF Cards: Supports a TF Card (Class 10 or above) with capacity of up to 128 GB	

• GIMBAL:

Stabilization: 2-axis (tilt, roll)	Controllable Range: Tilt -70° to 0°
Mechanical Range: Tilt +35° to -90° , Roll -40° to +40°	

• USB CHARGING CABLE:

Input: 5V/2A	Rated Power: ≤10W
--------------	-------------------

4.1 Specifications >>

• TRANSMITTER:

Operating Frequency: 2452–2474MHz	Max Flight Distance: 3281 ft/1000m <small>(outdoor and unobstructed)</small>
Battery Type: 3.7V 3000mAh Lithium-ion Polymer battery	
Operating Temperature Range: 32° to 104°F (0° to 40°C)	
Charging Time: 120 minutes	

4.2 Contact Us >>

Please do not hesitate to contact us if you need further support.



usa@deerc.com (America)
eu@deerc.com (Europe)
au@deerc.com (Australia)



+1 (334) 336-0888

4.3 Troubleshooting >>

Issues	Possible Causes	Suggested Solutions
Motors won't start.	Weak GPS signal.	(1)Ensure you're operating in an area with strong GPS reception. (2)For indoor operations, press and hold the RTH button to switch to ATTI mode. (See page 24)
	The drone's battery is running low (evidenced by the continuous flashing of RED light on the rear of the drone).	Charge the drone with an OEM charging cable. (See page 09)
	The compass isn't calibrated (evidenced by the continuous flashing of GREEN light on the rear of the drone).	Conduct a compass calibration. For step-by-step instructions, refer to the "Compass Calibration" section in the user manual. (See page 21)
	Gimbal is under self-check (front status indicator blinks blue, rear blinks red).	Wait 8 seconds for completion; indicators will then turn solid.
Unstable flight or abnormal posture	GPS signal instability due to flying near buildings or in areas with obstructions.	Operate the drone in open spaces free from obstructions.
	Compass interference	(1)Manually land the drone immediately and recalibrate the compass (2)Try operating in a different location, ensuring you're away from buildings, power lines, and signal towers.
	Propeller deformation or damage	Replace with new propellers.
Gimbal cannot stabilize.	Gimbal protection activated due to not removing the gimbal cover before powering on.	Ensure the gimbal cover is removed before powering on.
	Drone is not in a level position.	Place the drone on a level surface before turning it on and wait for the gimbal to complete its self-check.
	In compass calibration mode.	The gimbal doesn't function during compass calibration. After calibration, place the drone on a level surface and wait for the gimbal to stabilize and re-center.
	Drone placed on uneven surfaces like grass or sand.	Position the drone levelly on a landing pad or switch to another even surface. Ensure there's ample space below the gimbal and avoid obstacles that might affect its stabilization.

4.4 Compliance Information >>

FCC Notice:

This device complies with part 15 of the FCC Rules. Operation is subject to the following two conditions:

- (1) This device may not cause harmful interference, and
- (2) This device must accept any interference received, including interference that may cause undesired operation.

The Supplier's Declaration of Conformity is available at the following address:

https://www.deerc.com/Download/US/D65_FCC_sDoC.pdf

This equipment has been tested and found to comply with the limits for a Class B digital device, pursuant to part 15 of the FCC Rules. These limits are designed to provide reasonable protection against harmful interference in a residential installation. This equipment generates, uses and can radiate radio frequency energy and, if not installed and used in accordance with the instructions, may cause harmful interference to radio communications. However, there is no guarantee that interference will not occur in a particular installation. If this equipment does cause harmful interference to radio or television reception, which can be determined by turning the equipment off and on, the user is encouraged to try to correct the interference by one or more of the following measures:

- Reorient or relocate the receiving antenna.
- Increase the separation between the equipment and receiver.
- Connect the equipment into an outlet on a circuit different from that to which the receiver is connected.
- Consult the dealer or an experienced radio/TV technician for help.

Changes or modifications not expressly approved by the party responsible for compliance could void the user's authority to operate the equipment.

4.4 Compliance Information >>

RF Exposure:

The equipment complies with FCC radiation exposure limits set forth for an uncontrolled environment. This device should be installed and operated with minimum distance 20cm between the radiator & your body.

IC Notice:

This device complies with Canada Industry licence-exempt RSS standard(s).

Operation is subject to the following two conditions:

- (1) this device may not cause interference; and
- (2) this device must accept any interference. Including interference that may cause undesired operation of the device.

CAN ICES-003 (B)

Avis d'Industrie Canada

Le présent appareil est conforme aux CNR d'industrie Canada applicables aux appareils radio exempts de licence. L'exploitation est autorisée aux deux conditions suivantes:

- (1) l'appareil ne doit pas produire de brouillage; et
- (2) l'utilisateur de l'appareil doit accepter le brouillage radioélectrique subi même si le brouillage est susceptible d'empêcher le fonctionnement normal de l'appareil. Cet appareil numérique de la classe B est conforme à la norme NMB-003 du Canada.

4.4 Compliance Information >>

CAN NMB-003 (B)

RF Exposure

Radiation Exposure Statement:

This equipment complies with IC radiation exposure limits set forth for an uncontrolled environment. This equipment should be installed and operated with a minimum distance of 20cm between the radiator & your body.

Déclaration d'exposition aux radiations:

Cet équipement est conforme aux limites d'exposition aux rayonnements IC établies pour un environnement non contrôlé. Cet équipement doit être installé et utilisé avec un minimum de 20 cm de distance entre la source de rayonnement et votre corps.

EU RF Power(EIRP): <14 dBm (2452MHz-2474 MHz)

Caution

1. The max operating of the EUT is 45°C, and shouldn't be lower than -10°C.
2. The device complies with RF specifications when the device used at 0mm from your body.
3. Declaration of Conformity.

We, Xiamen Huoshiquan Import & Export CO.,LTD

hereby, declare that the compliance of the essential requirements with the Directive 2014/53/EU, the RoHS Directive 2011/65/EU and Safety Directive 2009/48/EC have been fully fulfilled on our product with

4.4 Compliance Information >>

Indication below:

Product Name: Remote control four axis series

Model/Mark: D65/Deerc

The Statement of compliance is available at the following address:

http://www.deerc.com/Download/CE/D65_EU_DOC.pdf

This product can be used among EU member states.

MANUFACTURER INFORMATION

Xiamen Huoshiquan Import & Export CO.,LTD.

Address: Unit 1, Room 501, Hongxiang Building, No.258 Hubin Nan Road, Siming District, Xiamen, China
+1(334)336-0888

MTOM Statement

D65 is a quadrotor drone. The MTOM of D65 is 246 g, including the propellers, the Flight Battery, TF card, which is compliant with C0 requirements.

Users must follow the instructions below to comply with the MTOM C0 requirements. Otherwise, the drone cannot be used as a C0 aircraft:

1. DO NOT add any payload to the aircraft except the items listed in the List of Items including qualified accessories section.
2. DO NOT use any non-qualified replacement parts, such as flight batteries or propellers, etc.
3. DO NOT retrofit the aircraft.

4.4 Compliance Information >>

List of Items including qualified accessories

1. D65 Propellers (1.7 g each propeller)
2. D65 Flight Battery (approx. 66 g)
3. D65 TF card (approx. 0.3 g)

List of Spare and Replacement Parts

1. D65 Propellers (1.7 g each propeller)
2. D65 Flight Battery (approx. 66 g)

List of Safe Guards

Below is the list of the mechanical safeguards and operation safeguards for D65.

1. Prevent the drone from flying in restricted airspace. Refer to the Flight Environment Requirements section for details.
2. The Return to Home (RTH) function. Refer to the GPS Return to Home section for details.
3. The Optical Flow Positioning. Refer to the Optical Flow Positioning section for details.



MADE IN CHINA(CN)