

Users Manual of DEVO-7 transmitter

Part one:General information	4
1.0 FOREWORD	4
1.1 <i>Important Statements</i>	4
1.2 <i>Safety Needing Attention</i>	5
1.3 <i>Attention Before Flight</i>	5
FEATURES	6
2. 1 <i>Transmitter DEVO-7。</i>	6
2. 2 <i>DEVO-RX701</i>	6
3. 0 SPECIFICATION.....	7
3. 1 <i>Transmitter Specification</i>	7
3.2 <i>Receiver Specification</i>	7
4.0 RADIO COVER IDENTIFICATION.....	8
4.1 <i>Face Cover Indicator Diagram</i>	8
4.2 <i>Back Cover Indicator Diagram</i>	9
4.3 <i>Wiring Diagram</i>	10
4.4 <i>Function keys in panel</i>	10
5.0 STICK ADJUSTMENT	10
5.1 <i>Stick Length Ajustment</i>	11
5.2 <i>Stick Tention Adjustment</i>	11
6.0 NECK STRAP USAGE	12
7.0 STICK MODE SWITCH	12
8.0 SWITCHES BETWEEN LEFT-HAND AND RIGHT-HAND THROTTLES	13
8.1 <i>Right Throttle Switch To Left Throttle</i>	14
8.2 <i>Left Throttle Switch To Right Throttle</i>	14
9.0 TRAINING FUNCTION	15
10.0 CUSTOMIZED FIXED ID	18
11.0 INSTALLATION REQUIREMENT FOR RECEIVER	19
12.0 INSTALLATION REQUIREMENT FOR BATTERY PACK.....	20
12. 1 <i>DEVO-7 Battery Charging</i>	21
PART TWO: HELICOPTER	22
SYSTEM MENU	22
1.1 (DISPL) <i>1.1 Display</i>	22
1.2 (<i>Buzzer Setting</i>)	23
1.3 (<i>STMOD</i>)	25
1.4 (<i>CALIB</i>)	26
1.5(<i>ABOUT</i>).....	27
2.0(MODEL MENU).....	28
2.1 (<i>Model select</i>)	28
2.2 <i>Model Name</i>	29
2.3 (<i>COPY</i>)	29
2.4 <i>Model wireless copy</i>	30

2.5 (RESET)	32
2.6 (TYPE)	33
2.7 (STEP)	34
2.8 Device select	35
2.9 Device Output.....	36
2.10 Swash type	38
2.11 (AMPLI)	38
2.12 Fixed ID	39
3.0 FUNCTION MENU.....	40
3.1 Reverse Switch.....	41
3.2 (Travel Adjust).....	41
3.3 (Sub Trim).....	42
3.4 Dual rate and exponential.....	43
3.5 Throttle hold.....	47
3.6Throttle Curve	48
3.7 Mix to throttle	50
3.8 GYRO SETTING.....	54
3.9 Governor.....	56
3.10 SWASH MIX	58
3.11Pitch Curve	60
3.12 Program Mix	64
3.13 (MONIT) Monitor.....	77
3.14 Fail safe	78
3.15 (TRAIN)	79
3.16 (TIMER)	81
PART THREE: AIRPLANE	84
1.0 SYSTEM MENU	84
1.1 (DISPL).....	84
1.2 Buzzer warning	85
1.3 Stick Mode	87
1.4 Calibration.....	88
1.5(ABOUT).....	89
2.0(MODEL MENU).....	90
2.1 Model Selec.....	90
2.2Model Name	91
2.3 Model Copy.....	91
2.4 Model wireless copy	92
2.5 Model RESET.....	94
2.6TYPE OPTION.....	95
2.7 Trim system.....	96
2.9 Device Output.....	98
2.10 (WING)	101
1.7 Power amplifier.....	105
2.12 (FIXID)	106
3.0 FUNCTION MENU.....	108

3.1 Reverse Setting	108
3.2 Travel Adjust	109
3.3 (Sub Trim)	109
3.4 Dual rate and Exponential	110
3.5 Throttle hold	114
3.6 Throttle curve	115
3.7 Differential	119
3.8 Balance	127
3.9 Gyro sensor	128
3.10 Governor	131
3.11 Aileron to Rudder Mix	132
3.12 Elevator to flap mix	135
3.13 Rudder to aileron/elevator mix	138
3.14 (FLAPS)	143
3.15 Aileron to flap mix	147
3.16 (PRGMX)	151
3.17 (MONIT)	160
3.18 (Fail -Safe)	161
3.19 (TRAIN)	162
3.20 (TIMER)	165
PART FOUR: UPGRADE INTERFACE	167

Welcome to use the DEVO-7 transmitter

Note: Please read thoroughly the manual before using and keep it in a safe place for the future reference.



Users Manual of DEVO-7 transmitter

Part one:General information

1.0 Foreword

DEVO-7 adopts 2.4 GHz Direct Sequence Spread Spectrum (DSSS) technology and features automatic ID binding, automatic ID assignment, and also features fixed ID set by you yourself. The usage of wireless copy function keeps you away from the trouble in wire link-up. Three mode types of helicopter, airplane and glider are available to meet your requirements for different models. The 2.8"LCD display big size letter which offers more convenient operation. USB update on-line ensures a transmitter in hand not to be out of date and makes it full of vigour.

1.1 Important Statements

(1) The transmitter is suitable for experienced radio controlled helicopter modelers beyond 14 years old.

(2) Flying the model aircraft in approved ground is a must.

(3) We are not responsible for any safety caused by operation, usage or control as soon as the transmitter is sold out.

(4) We consign our distributors to offer technical support and after sale service. Please contact the local distributors for problem solutions caused by usage , operation, maintenance, etc.

1.2 Safety Needing Attention

(1) Far away from obstacle and people

RC helicopter in flight is uncertain of flight speed and status, which potential risk exists in. when flying, please keep your RC helicopter far away from people, high buildings, high-tension line, etc, and avoid operating in rain, storms, thunder and lightening.

(2) Away from humidity environment

RC helicopter should be kept away from humidity and vapor because it is composed of complicated precise electronic elements and mechanic parts.

(3) Proper operation

Please use original spare parts to upgrade, modify or maintain your equipment in order to assure its safety. Please operate your equipment within the range of functions permitted. It is forbidden to use out of the safety laws or regulations.

(4) Safety operation

Please operate your equipment according to your body status and flight skills. Fatigue, listlessness and mis-operation will increase the possibilities of accidental hazard.

(5) Away from heat sources

The inside of the transmitter is composed of many precise electronic components and mechanical parts. Keep it far away from heat sources and sunshine to avoid distortion, or even damage caused by high temperature.

1.3 Attention Before Flight

(1) Ensure the battery packs of both transmitter and receiver are fully charged (saturated).

(2) Ensure both the throttle stick and the throttle trim of your transmitter stay at the lowest positions before operation.

(3) Please strictly obey the order of turn-on and turn-off before operation. When starting your flight, turn on your transmitter first, and connect the battery to the helicopter later. When turning off the helicopter, disconnect the battery first, and turn off your transmitter later. An upset in the order of connection may cause your helicopter out of control. Please form a correct habit of turn-on and turn-off.

(4) Ensure whether the directions and actions of the servos are correct when executing commands of the transmitter. Using a broken servo will result in unforeseen dangers.

2.0 Features

2.1 Transmitter DEVO-7。

- 1) The DEVO-7 adopts 2.4 GHz Direct Sequence Spread Spectrum (DSSS) technology and features automatic ID binding and ID assignment. It can also be customizedly set as fixed ID code.
- 2) USB online update makes you always enjoy the latest programme.
- 3) Adjustability of hi-frequency output power enjoys more personality and friendly environment.
- 4) Wireless data transmission between two DEVO-8 helps experience the training function.
- 5) Up to 15-model data can be saved.
- 6) DEVO-8 adjusting the gyro sensitivity makes hovering flight and fancy flight in an easy way.
- 7) Ultra big size LED screen ,display letter in big size, features direct and more convenient setting.
- 8) Shape design accords with human engineering and provides comfortable holding.
- 9) Both the length and tension of the sticks can be adjustable.
- 10) DEVO-7 can be freely switched among Modes 1, 2, 3 ,and 4.
- 11) DEVO-7 is suitable for helicopter and airplane. In the helicopter mode, there are 3 flight modes, each of which can be freely set and its parameters can be personalizedly adjusted to meet the requirement for F3C or 3D aerobatic flight.

2.2 DEVO-RX701

- 1) Adopts 2.4GHz Direct Sequence Spread Spectrum (DSSS) that features fast reaction and strong anti-jamming protection.
- 2) Double receiving circuits and signal switch automatically effectively assure the stability of receiving signal.
- 3) The Single Chip Microco as CPU provides super-strong analysing ability.
- 4) The receiver maintains the frequency and the ID memories when its changing a

new battery pack with the transmitter powered on.

- 5) It can be customizedly set as fixed ID and automatic ID assignment.

3. 0 Specification

3. 1 Transmitter Specification:

Encoder: 7-channel micro computer system

Frequency: 2.4GHz DSSS

Output power $\leq 100\text{mW}$

Current drain $\leq 230\text{mA}$ (100mW)

Power supply 5# Battery 8X1.5V or NiMH 8X1.2V1600-2000mAh

Output pulse: 1000—2000Ms (1500 Neutral)

3.2 Receiver Specification:

Type: 2.4GHz 7 channels

Sensitivity:- 105dbm

Frequency Interval: $\geq 4\text{M}$

Weight: 11.6g

Dimension: 43X28X16mm

Receiver Battery: 4.8-6V1300mAh

4.0 Radio Cover Identification

4.1 Face Cover Indicator Diagram



4.2 Back Cover Indicator Diagram



1. Handle

2. Cover Screw

3. Digital Signal Converter socket (DSC): used for simulator flight practice via computer (You need a software and its dongle which are available in hobby shops), and for training.

4. Battery Pack Cover

5. Charge socket (CHG): input DC at 12V, Current 50MAH; Polarity: $\oplus \rightarrow \ominus$

4.3 Wiring Diagram

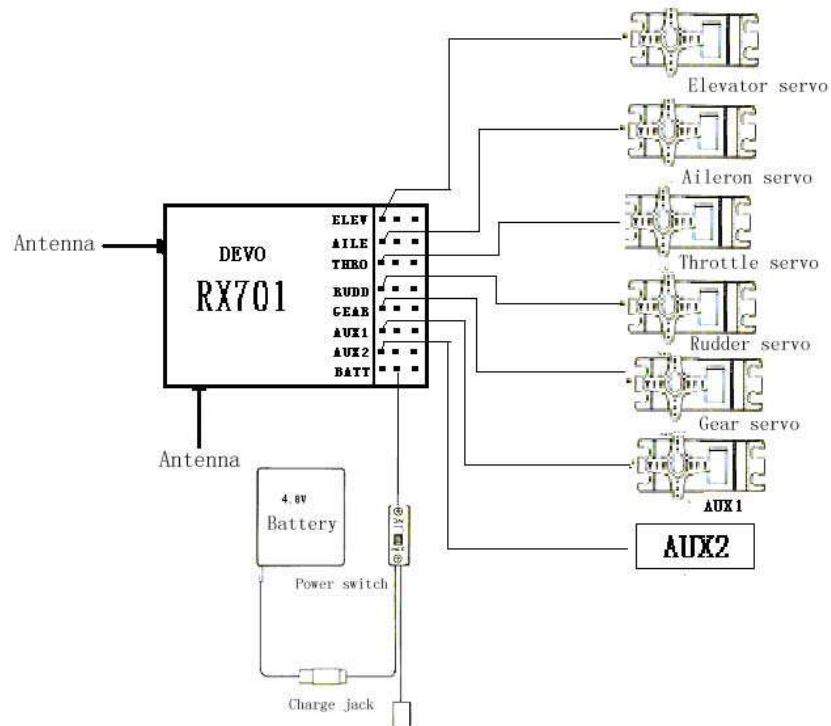

4.4 Function keys in panel

There are 6 functional keys in the panel of DEVO-7. Below are the details:

- EXT: Reset key, Press EXT to exit the main menu.
- ENT: Confirmation key. Press ENT to access the system or the function mode.
- UP: Moves cursor up to the forward function item
- DN: Moves cursor down to the next Function item
- L: Moves cursor down or increases the setting value
- R : Moves cursor up or decreases the setting value

5.0 Stick Adjustment

Two parts of stick adjustment: length and tension adjustment.

5.1 Stick Length Adjustment

Prolong the stick length: CCW rotate the stick head until the length you hope, and then CCW tighten the stick sleeve;

Shorten the stick length: CW rotate the stick sleeve until the length you hope, and then CW tighten the stick head.



5.2 Stick Tention Adjustment

Use the screw driver to loosen the 6 screws in the back cover, take down the base plate as below:



Find the inside structure of the left and right throttle stick as below. Use the cross screw driver adjust the screw F and G, clockwise will tighten the crew while counterclockwise will loosen the screw; Cover the base plate after accomplishment.

Right Throttle Position

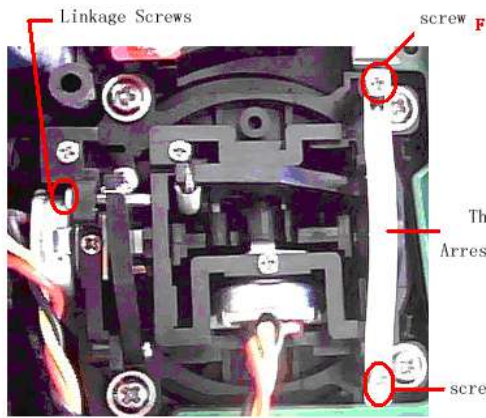

Left Throttle Position

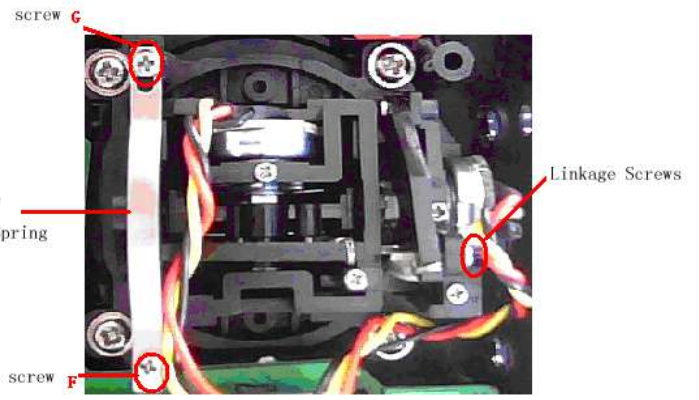

6.0 Neck Strap Usage

The hook located at the center position of the transmitter. The neck strap can be connected to the hook. The Hook helps to get optimal balance of the transmitter.

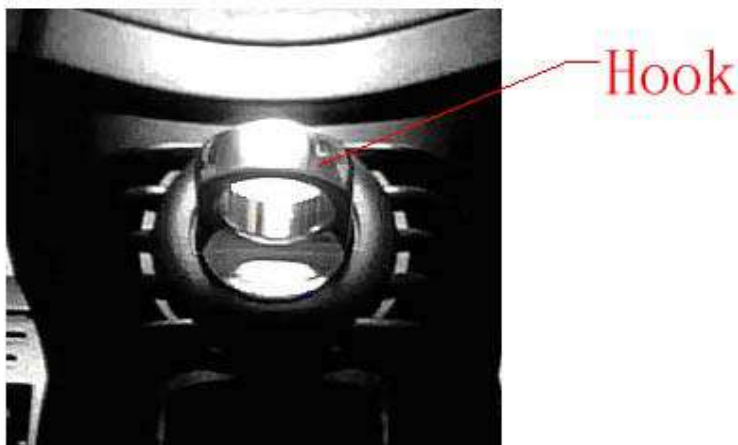

7.0 Stick Mode Switch

There are total four stick modes from MODE 1 through MODE 4. The left-hand throttle includes MODE 1 and MODE 3, and the right-hand throttle includes MODE 2 and MODE 4. Below is the sketch map:

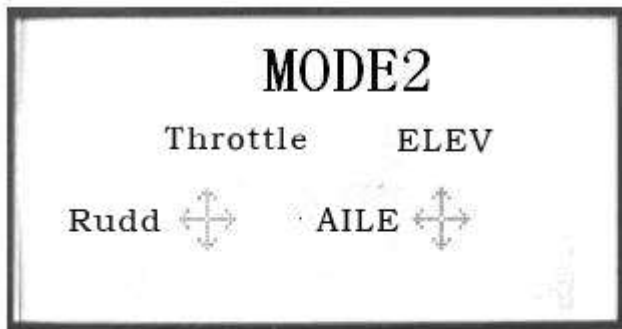

MODE 2 and MODE 4 are listed in left-hand throttle.

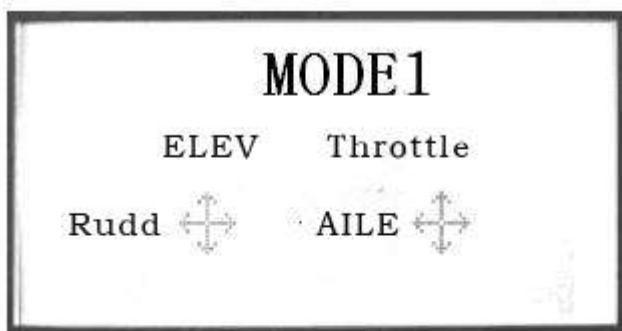

MODE 1 and MODE 3 are listed in right-hand throttle.

8.0 Switches between left-hand and right-hand throttles

The throttle switch between the left hand and right hand will be successful if both the MECHANICAL switch and ELECTRONIC switch are finished, separately. Below are

the methods for switching:

8.1 Right Throttle Switch To Left Throttle

1) MECHANICAL switch

Remove the 6 fixed screws in the base plate. Below are shown the inside views of left and right throttle sets, respectively. Use cross screwdriver to loosen and remove Linkage Fixed Screw, Screw F, Screw G, and Throttle Control Spring in right throttle set, respectively, and then mount them in the corresponding positions in left throttle set. And then adjust the screw F tension according to your habit. Cover the base plate after accomplishment

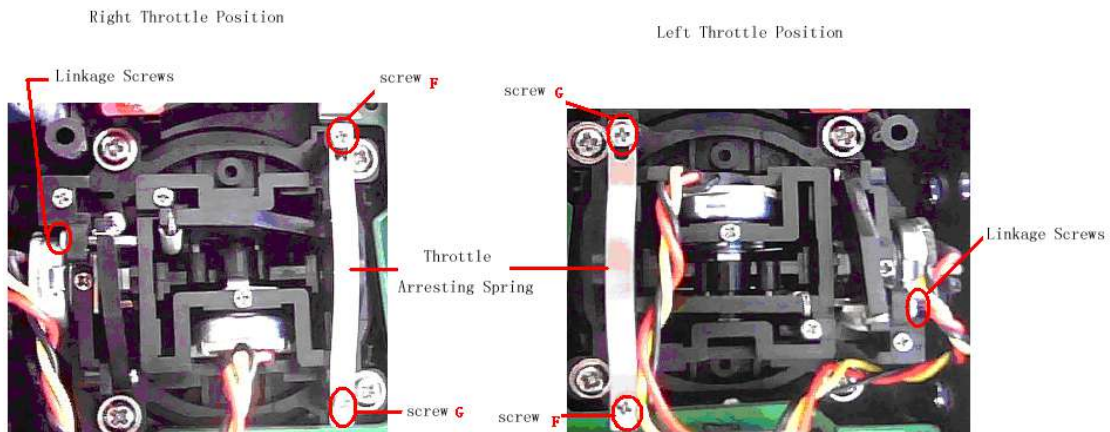

2) The ELECTRONIC switch

In the main surface touch the “ENT” Icon, it will come out the flashing “System”. Touch the “ENT” Icon to enter System Menu; and then touch the UP or DN to enter the flashing “**STMOD**” menu, press “ENT” and then select the mode you desire. Touch UP or DN, then come out the flashing “MODE2” or “MODE4”, touch “EXT” icon to exit.

The model data will be automatically switched when touching MODE 2 or MODE 4.

The switch from right-hand throttle to left-hand throttle is finished after both the MECHANICAL and ELECTRONIC switches changed, respectively. And the transmitter is ready to normally work now.

8.2 Left Throttle Switch To Right Throttle

1) MECHANICAL switch

Refer to the above steps of “MECHANICAL switch”, open the base plate

Remove the 6 fixed screws in the base plate. Below are shown the inside views of left and right throttle sets, respectively. Use cross screwdriver to loosen and remove Linkage Fixed Screw, Screw F, Screw G, and Throttle Control Spring in left throttle set, respectively, and then mount them in the corresponding positions in right throttle set. And then adjust the stick tension according to your habit.

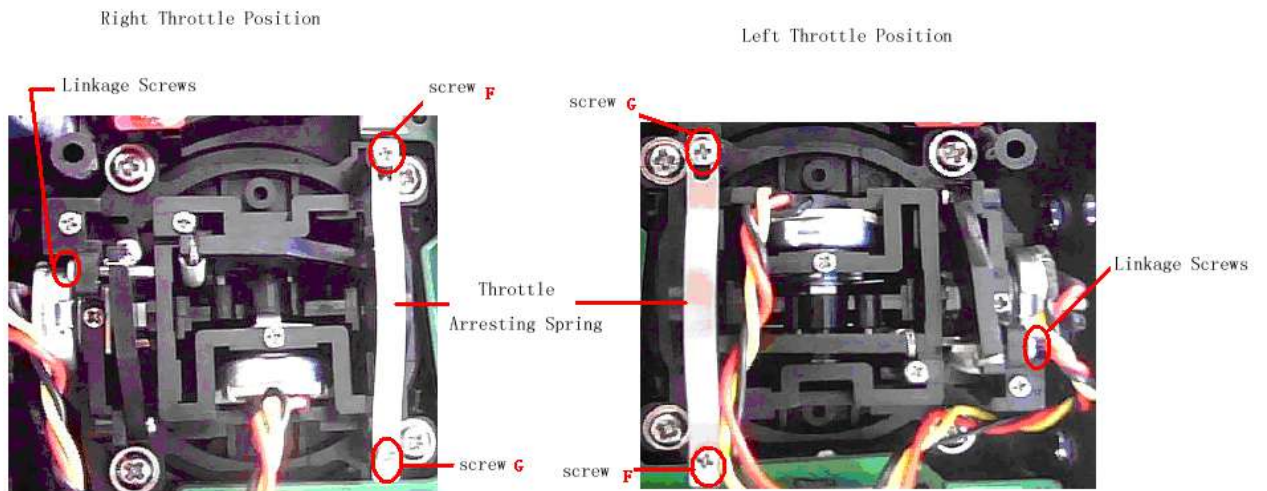

2) The data switch

In the main surface touch the “ENT” Icon, it will come out the flashing “System”. Press the “ENT” Icon to enter System Menu; and then press the UP or DN to enter the flashing “**STMOD**” menu, press “ENT” and then select the mode you desire. Press UP or DN, then come out the flashing “MODE1” or “MODE3”, press “EXT” icon to exit.

The switch from right-hand throttle to left-hand throttle is finished after both the MECHANICAL and ELECTRONIC switches changed, respectively. And the transmitter is ready to normally work now.

Note: Pay attention to the strength when removing and adjusting the screws. Excessive strength may damage them.

9.0 Training function

Two DEVO-7 transmitters working together can execute the training function to meet the requirements for the beginner. The setting method is shown as below:

1) Data copy

First, use the wireless copy function between two DEVO-7 to copy the main

transmitter's model data to the trainee's transmitter, this promise the the model data between two transmitters is same. Refer the copy method to the second part of helicopter "2.4 model wireless copy" and do the following steps:

2) Linkage

Insert the signal wire from the trainer's transmitter into the DSC socket of the trainee's transmitter. Turn on the transmitter and a linkage will be shown on the boot screen. Show as below. Find out the trainee's model data.



Linkage Display

Turn on the power of the trainer's DEVO-7. Find out the trainee's model data, and then let the trainer's DEVO-7 bind with the assigned model, fly it normally. Then turn off the power Insert the other end of the digital signal wire into the trainer's DEVO-7, and then turn on its power. A linkage icon will be shown as below:

3) Setting for training function channels

Trainee is available to get full or part of flight control power to the aircraft model via setting the training function channel in the trainer's DEVO-7. Below is the setting method:

Press the "ENT" in the main interface, It will come out the flashing "Function" menu; press UP or DN to make the main interface come out the flashing "TRAIN" menu; Press "ENT" to enter the function channel. Touch UP or DN, choose the required channel, press R or L to change the control, INT is forbidden, ACT is granted. Press "EXT" to exit after accomplished setting.

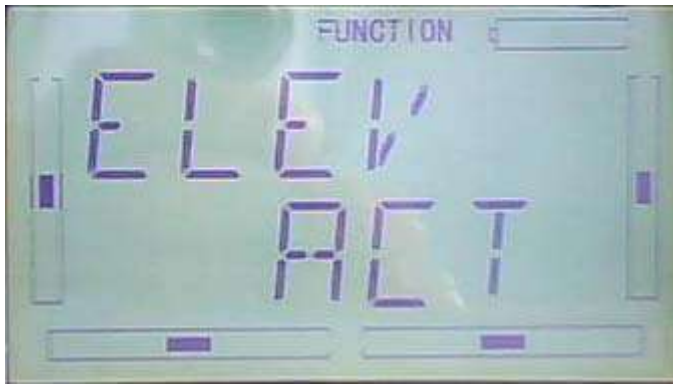

4) Usage method

The training switch is above the left corner, named HOLD/TRN, see below:



When flying, if the trainer push forward the TRN switch, it means the trainer has already transfer the operate control to the trainee. At the same time, the output data displayed on the boot screen belong to the trainee's operate data. If the trainer push back TRN switch, it means the trainer has recycle the operate control from the trainee and the transmitter was operate by the trainer.

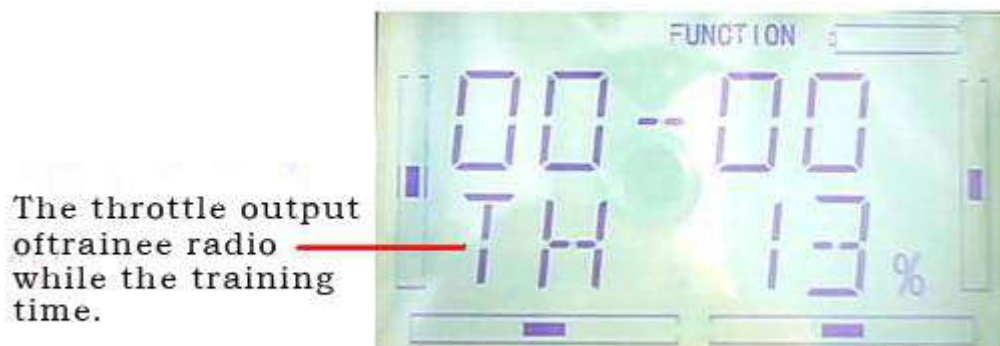

10.0 Customized fixed ID

This setting will bind the transmitter with its receiver in a unique corresponding relationship. It will greatly speed up the time of automatic binding.

1) Setting for fixed ID

The setting for fixed ID should be under the status that automatic ID binding is successfully finished. Below is the setting method.

Press the “ENT” on the main surface, it will come out the flashing main menu, press UP or DN, come out the flashing “MODEL”, press “ENT” to enter Model menu; Press UP or DN, it come out the flashing “FIXID” menu, Press “ENT” to enter the Switch status Choose. Press R or L, choose “ON”, press DN to enter fixed ID setting.

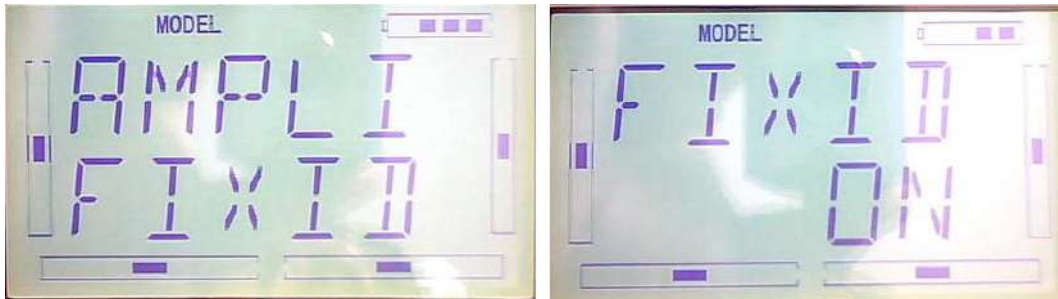

Press ENT to change the data, press R or L to change the data; Press DN to move the next data. After setting, press ENT, it will come out “RUN” interface. Press R or L to change ON to YES, press ENT to make ID binding, it will automatically back to model menu after accomplishment.

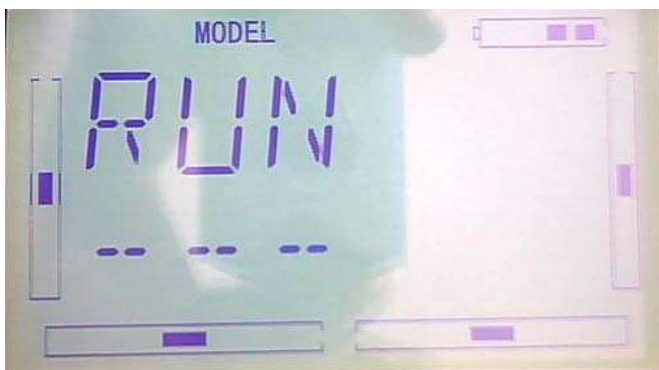
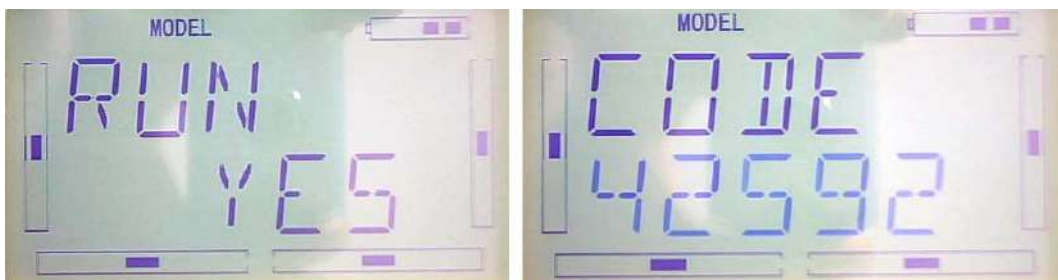

2) Fixed ID cancellation

Insert the assorted BIND PLUG into the output terminal of BATT before the receiver is powered on, and then plug 5V DC power into other output terminal. The red light of receiver will flash slowly. This means the fixed ID code has been cancelled. Pull out BIND PLUG.



After the receiver's Fixed ID cancelled, the transmitter also need to have corresponding reset setting.

Referred to above fixed ID setting, if come to the following Image, press UP.

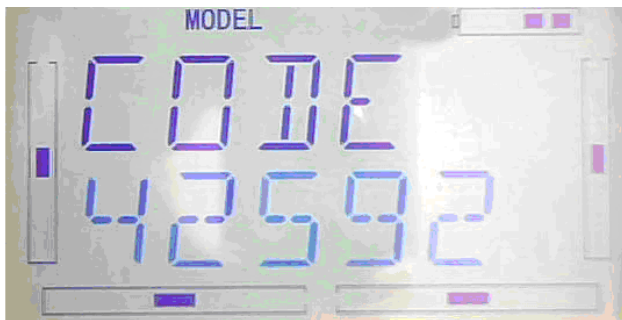

If come to the following image, press R or L , turn ON to OFF, press EXT to exit.

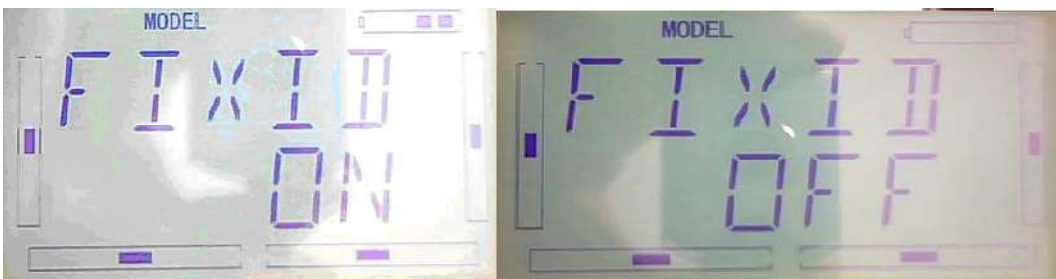

11.0 Installation requirement for receiver

1) / It is important to correctly mount your radio system in your model. Below are

some advices on how to install your equipments.

- 2) Wrap the receiver with 10mm thick foam and fix it with a rubber band or magic string on your helicopter or airplane. It helps protect the receiver.
- 3) It is necessary for you to use rubber grommets and copper sleeves to isolate the vibration from the main body. The mounting screws cannot be over-tightened. Otherwise, the rubber grommets will be distorted and decrease the vibration absorption effect.
- 4) When mounting the servos, make sure the servos' bellcranks can move freely over their whole travel range and ensure the control linkages don't touch or impede the movement of the servos.
- 5) If installing various switches, please keep them far away from the engine tuned pipe and high vibration sources. Ensure all the switches move freely over their whole range.
- 6) Don't make the receiver antennas wrapped or parallel.



12.0 Installation requirement for Battery pack

Open the battery cover of the transmitter and take out the battery box. Then put 8 cells AA battery or the same size full charged 8 cells NIMH battery into the battery box. Please check again to make sure the polarities are correct.

Warning: Do not put the polarities of batteries in the opposite directions.



12. 1 DEVO-7 Battery Charging

Warning: the CHG socket is only used for the rechargeable NIMH batteries. If using the batteries which is unchargeable. The CHG socket is not allowed to use.

Charge socket (CHG): input DC at 12V, 50mA; Polarity: $\oplus \rightarrow \ominus$



Part two: Helicopter

System menu

All the functional settings, which are relative to the operation system of DEVO-7 itself, are **FULLY** integrated in System Menu. They include Display, Buzzer, Stick Mode, Stick & Lever, and About.

Below is the boot screen of helicopter:

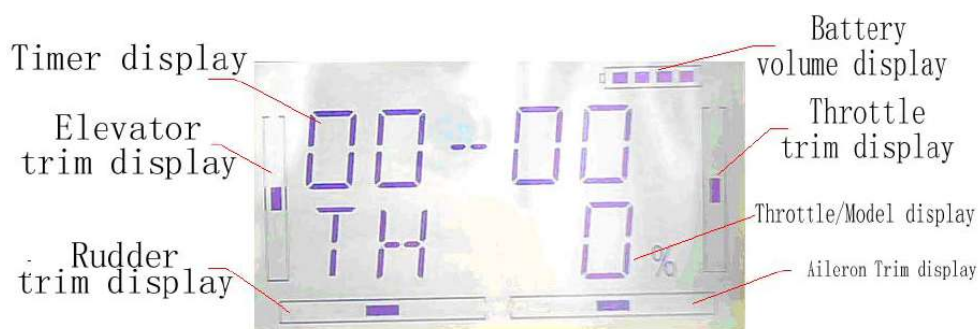

1.1 Display

1.Backlight lightness: the backlight lightness is adjustable by touching the navigation marks. The power consumption will be increased if the backlight lightness is too bright and the battery cruise duration will be shortened.

2.Backlight time out: it is possible to set the duration which LCD stays at highlight in the form of "Always on" or any period from 5 to 60 seconds with an interval of 5 seconds.

3.Setting: press "ENT" key to get the flashing main menu. Press UP and DN keys until "SYSTEM" becomes flashing, then press "ENT" key to the system menu. Press UP or DN to get the flashing "DISPL" menu, press "ENT" to go to backlight adjustment interface. Press R or L to adjust the backlight lightness or close it.



Press DN to set Backlight time out, press R or L to adjust the period up to 60 seconds, while 0 shows always ON. Press EXT key to exist after finished.



press EXT to exit

1.2 (Buzzer Setting)

Setting:

- 1) (STATE) Buzzer switch: press "ENT" key to get the flashing main memu. Press UP and DN keys until "SBUZZE" becomes flashing, then press "ENT" key to the STATE setting menu. Press R or L until the flashing characters to be ON or OFF, ON is to set the Buzzer as active; while OFF is to set it as inhabit.

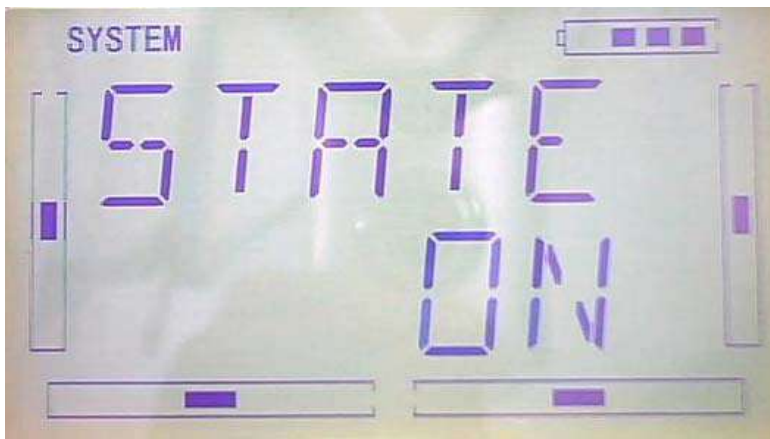

- 2) (THSTK) Throttle stick: under Buzzer Switch is at the status of On, if Throttle Stick is set as "Active", a relative musical scale will make response when moving the throttle stick. You can judge the position of the throttle stick according to the different musical scales. Also, it can be set as Inhibit.

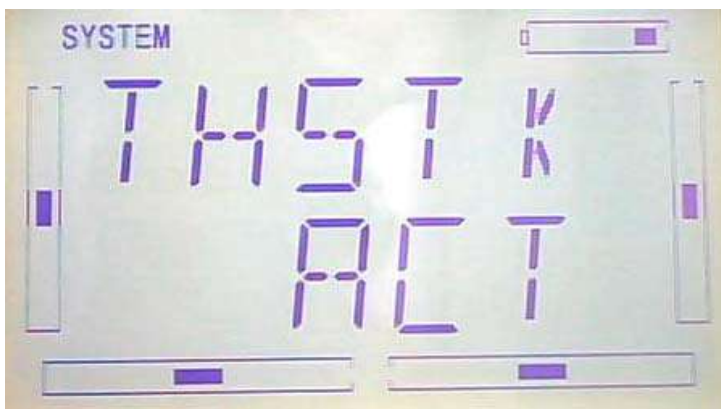

After finishing the above setting, press DN key until getting THSTK setting menu. Press R or L key to change the flashing characters to INH or ACT, ACT is to set the Buzzer as active; while INH is to set it as inhabit.

- 3) (TONE) Buzzer tone: the tone is composed of 10 grades. You can choose the favorite tone according to your interests.

After finishing the above setting, press DN key until getting TONE setting menu. Press R or L key to change the flashing characters to numbers like 1-10.

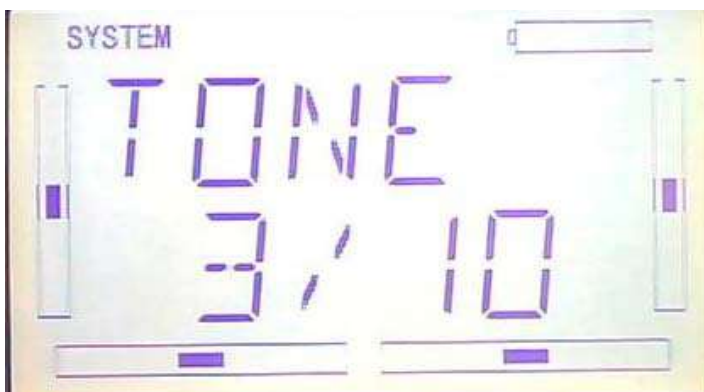

Press EXT key to exist after finished.

1.3 (STMOD)

There are 4 stick modes including MODE1, MODE2, MODE3 and MODE4. Right hand throttle includes MODE1 and MODE3; while left hand throttle includes MODE2 and MODE4. See Below:



MODE 2 and MODE 4 are listed in left-hand throttle.

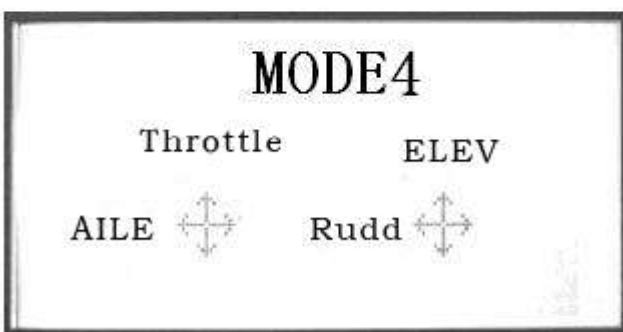
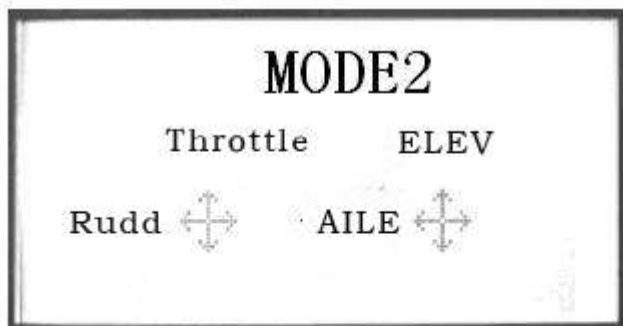

Setting: (STMOD) Stick Mode: press "ENT" key to get the flashing main menu. Press UP and DN keys until "STMOD" becomes flashing, then press "ENT" key to the Stick Mode setting menu. Press R or L to select the required stick mode until it becomes

flashing. Press ENT to confirm and press EXT to exist after finished.

1.4 (CALIB)

Press “ENT” key to get the flashing main menu. Press UP and DN keys until “CALIB” becomes flashing, then press “ENT” key to Stick Calibration setting menu. After pressing ENT key, you will get the below interface:



Stick calibration: Clockwise or counter clockwise mechanically move the right stick and left sticks from minimum levels to maximum levels several times, and then return the sticks to the neutral positions, respectively.



When you get the below interface after pressed ENT key, it shows the calibration is successful.



When you get the below interface after pressed ENT key, it shows the calibration is failed, then you need to repeat the calibration.



Press EXT key to exist after finished.

1.5(About)

press "ENT" key to get the flashing main menu. Press UP and DN keys until "SYSTEM" becomes flashing, then press "ENT" key to system setting menu. Press UP or DN key until "SOFT" becomes flashing; Press ENT key, you will find the version information under the SOFT interface.



Press EXT to exist after finished.

2.0(Model Menu)

Model Menu manages all the model data saved in DEVO-7. It includes Model Select, Model Name, Model Copy, Model Transmit, Model Receive, Model Reset, Type Select, Trim System, Device Select, Device Output, Swash Type, Power Amplifier and Fixed ID.

2.1 (Model select)

Press “ENT” button to enter Main Menu, press UP or DN until “MODEL” becomes flash, then Press “ENT” button to enter Model Menu; Press UP or DN until “SELEC” becomes flash and then press “ENT”key to get model options.

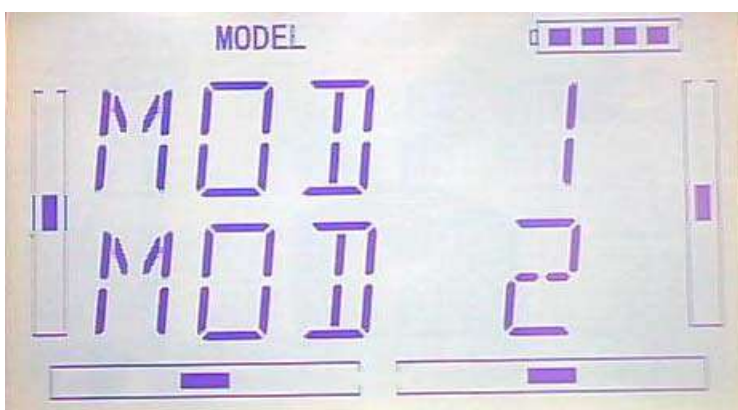

Press UP or DN key to flash the model you desired, total 15 models are optional. Press ENT to confirm, then press EXT to exit.

2.2 Model Name

In the menu of model name, you can make a desired name for your model for long term storage. Its data can be directly withdrawn in next flights.

Repeat the step "2.1 Model Select" to choose the model you want to name or save.

Press "ENT" button to enter Main Menu, press UP or DN until "MODEL" becomes flash , then Press "ENT" key to enter Model Menu; Press UP or DN until "NAME" becomes flash and then press "ENT" button to get the Model serial NO. and original name options.

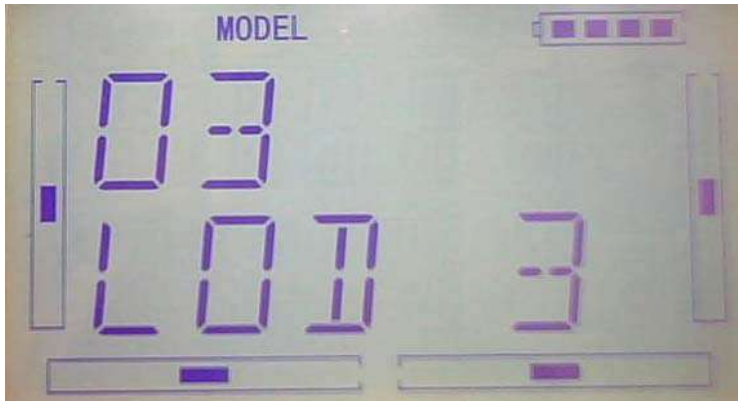

Press UP or DN key can move the character and figure, which are needed to be changed, Press R or L button to change the character and figure. EXT it after finish.

2.3 (COPY)

Press "ENT" button to enter Main Menu, press UP or DN until "MODEL" becomes flash , then Press "ENT" key to enter Model Menu; Press UP or DN until "copy" becomes flash and then press "ENT" button to get the Model name options. Press R or L can change the selected model.





Press ENT to choose the model the enquiry interface of whether to copy will be shown.
Press R or L to select YES for reset or NO for Cancel.

Press ENT to copy and EXT to exit.

2.4 Model wireless copy

The model data between two DEVO-7 equipments can be wirelessly copied via Model Transmit and Model Receive in Model Menu

1) Model transmission

Press "ENT" button to enter Main Menu, press UP or DN until "MODEL" becomes flash , then Press "ENT" key to enter Model Menu; Press UP or DN until "TRANS" becomes flash and then press "ENT" button to choose the source model.Press R or L can change the selected model.



Press ENT to choose the model that need to transmit, the enquiry interface of whether to transmit will be shown. Press R or L to select YES for copy or NO for Cancel.



Below is the picture show the interface of transmitting after press ENT.



Press EXT to exit.

2) Model receiving

Press "ENT" button to enter Main Menu, press UP or DN until "MODEL" becomes flash , then Press "ENT" key to enter Model Menu; Press UP or DN until "RECEI" becomes flash. The enquiry interface of whether to transmit will be shown after press ENT. Press R or L to select YES for Receiving or NO for Cancel.



Choose YES for receiving, then press ENT "Connecting" interface will be shown.

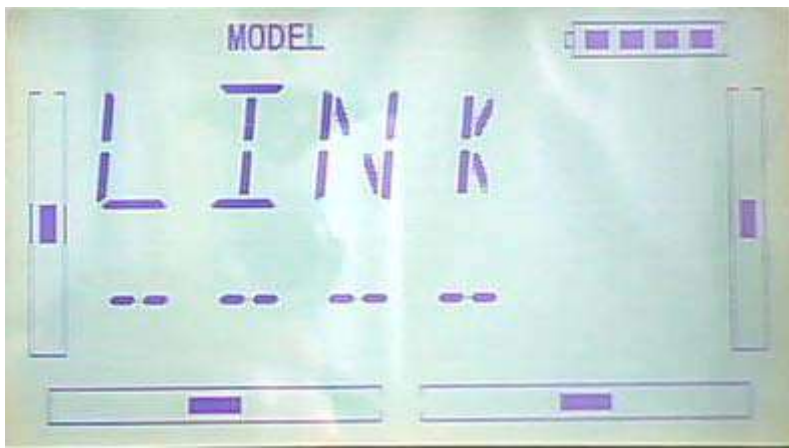

After receiving the data, the flash model name will be shown on the interface. Press R or L can change the save position. Press ENT, there is an enquiry interface will be shown. Press R or L to select YES for SAVE or NO for Cancel.

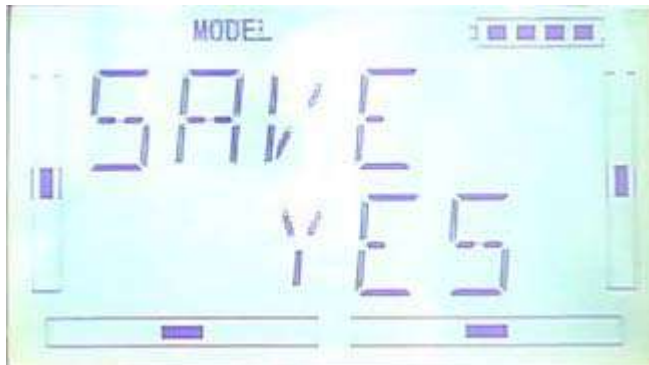

Data will be saved after press ENT then back to menu. Press EXT after saving.

2.5 (RESET)

All the model data can be restored to factory settings via Model Reset.

Press "ENT" key to enter Main Menu, press UP or DN until "MODEL" flash, and then Press "ENT" key to enter Model Menu; Press UP or DN button until "RESET" becomes flash; Press "ENT" key, there are There are batch reset and single reset selections. Press R or L to choose ALL or other models.

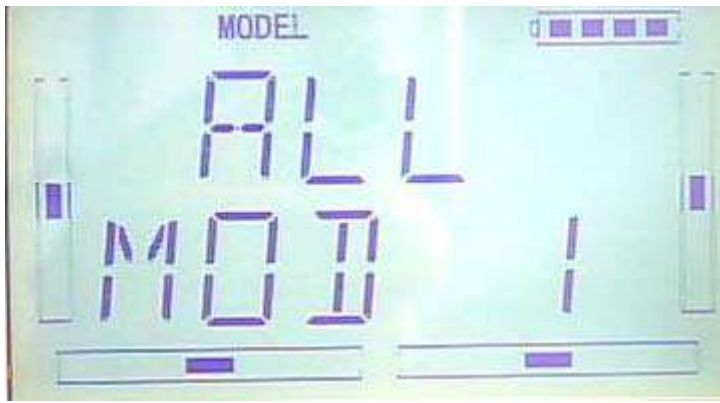

Press ENT to choose the model name that need to be reset,the enquiry interface of whether to reset will be shown. Press R or L to select YES for reset or NO for Cancel

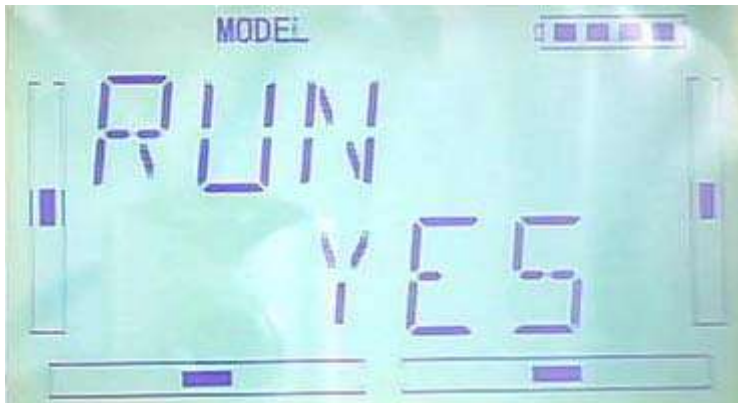

After choosing YES,please press ENT to reset and return back to menu after reset. Press EXT to exit.

2.6 (TYPE)

This device offers two model types menu. They are helicopter and airplane respectively.

Press "ENT" key to enter Main Menu, press UP or DN until "MODEL" flash , and then Press "ENT" key to enter Model Menu; Press UP or DN button until "TYPE" becomes flash; Press "ENT" key to get helicopter and Aeroplane selections. Press R or L button until selected model becomes flash, Press ENT button to confirm, then press EXT to exit.

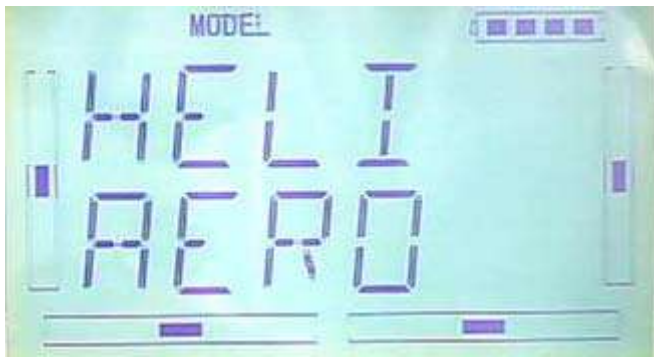

2.7 (STEP)

Trim System is able to finely tune the following items, respectively: Elevator, Aileron, Rudder, Throttle, Left Trim, and Right Trim, etc. The trim range is divided into 20 grades (factory default is set at 4). It is convenient to subtly modify the pitch by adjusting the trim range.



For elevator, aileron, and rudder, there are two more options: Normal and Limited. "Normal" means the trim is always working although the corresponding stick stays anywhere. "Limited" means the trim is out of working when the corresponding stick is at maximum position.

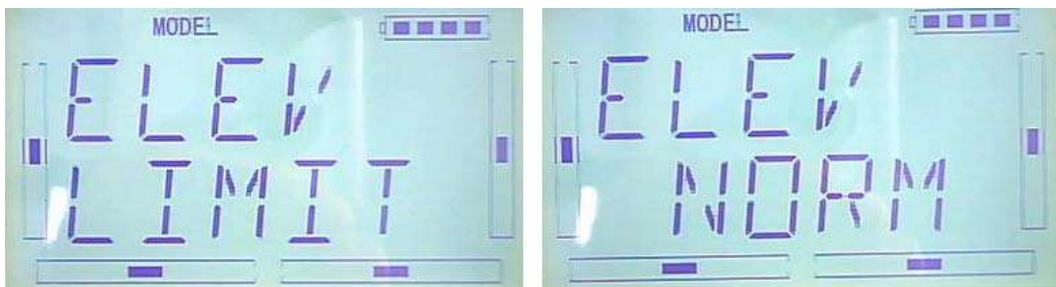

Press EXT to exit after setting.

2.8 Device select

This setting can help you configure various functional switches, or adjust levers. It includes Flight Mode Switch, Stunt Trim Select, Throttle Hold Switch.

Press "ENT" key to enter Main Menu, press UP or DN until "MODEL" flash , and then Press "ENT" key to enter Model Menu; Press UP or DN button until "INPUT" becomes flash. There are different options including Flight Mode Main Switch, Stunt Trim Select, Throttle Hold Switch after press ENT.

- 1) Flight Mode Switch: Press R or L to choose FMD or MIX switches. factory default setting is FMD .

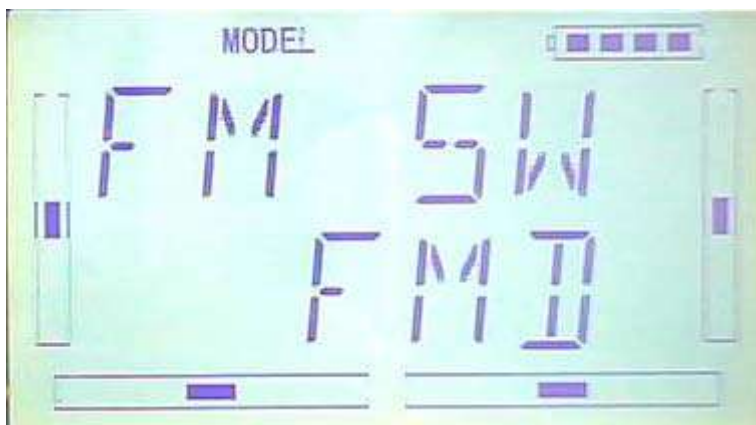

- 2) Stunt Trim Select: There are two modes: Common and Flight Mode. In Common mode all the trim values, which various sticks are corresponding to, put equally effects on all the flight modes.

In Flight Mode, the trim value, which each stick is corresponding to, puts independently effect on the corresponding stick. The factory default is Common.

Setting: After the setting 2), below interface will be shown after press DN. Press R or L to choose Common(COMM) and Flight Mode(FMOD).

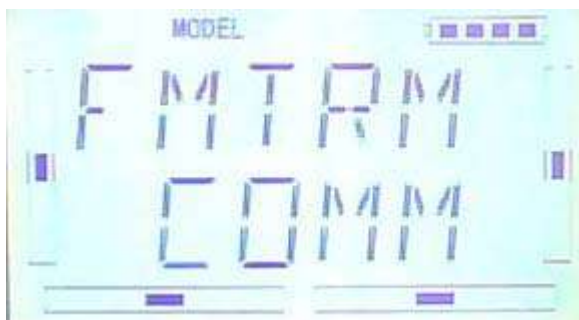

- 3) Throttle Hold Switch

Throttle Hold switch including Gear Switch, hold Switch, D/R switch, MIX2, MIX12, FMD2, FMD12. Factory default setting is HOLD switch.

Setting:After the setting 2), below interface will be shown after press DN.Press R or L to choose corresponding switch.

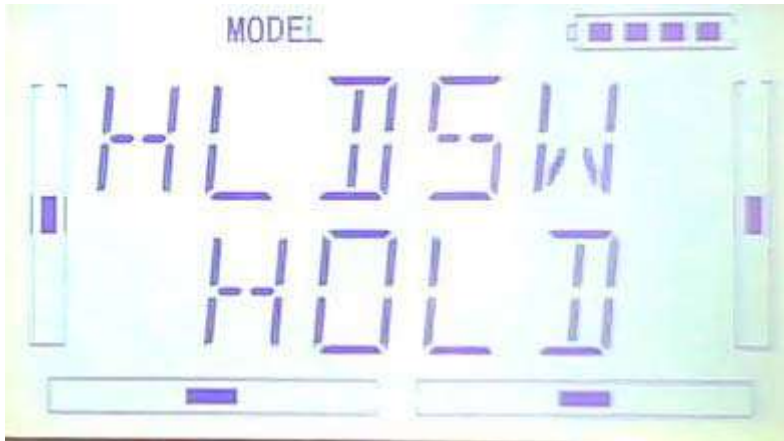

Press EXT to exit after the settings.

2.9 Device Output

Device output can set up the output switches respectively. It can also activate, inhibit or use other functions.

Setting:Press “ENT” key to enter Main Menu, press UP or DN until “MODEL” flash , and then Press “ENT” key to enter Model Menu; Press UP or DN button until “OUTPU” becomes flash. The available GEAR,AUX2 options and switches will be shown after press ENT.

1)Press R or L in OUTPU interface can change the gear switch. It includes FMD, MIX D/R, HOLD,TRN and AUX2. The default setting is GEAR SW.

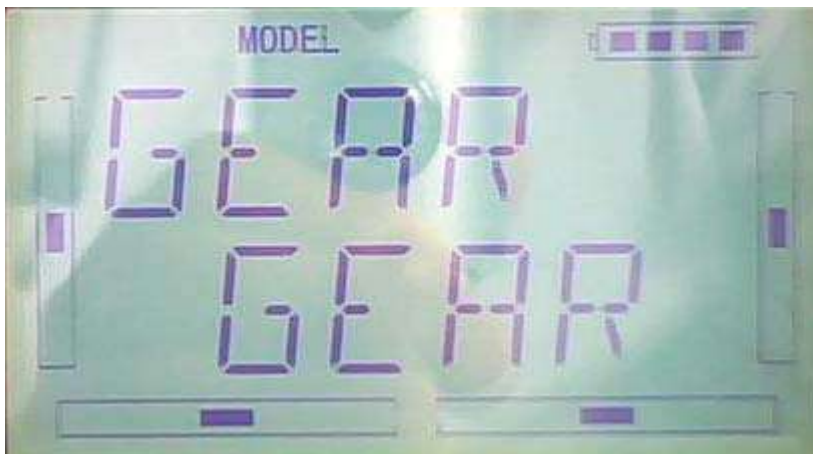

Press DN can enter the interface of Gear activate, inhibit or use other functions.

2)Press R or L can change activate, inhibit or use other functions which includes INH,ACT and GYRO.



3) (AUX2)

After the GEAR setting, Press DN to enter the AUX2 interface. Press R or L can change the AUX2 switch. It includes FMD、MIX、D/R、HOLD、GEAR、TRN and AUX2. The default setting is AUX2.



Press DN can enter the interface of AUX2 activate, inhibit or use other functions.

Press R or L can change activate, inhibit or use other functions which includes INH,ACT,GYRO and GOV(governor).



Press EXT to exit.

2.10 Swash type

The swash type is grouped into five options: 1 Servo Normal, 2 Servos 180°, 3 Servos 140°, 3 Servos 90°, and 3 Servos 90°.

Setting: Press “ENT” key to enter Main Menu, press UP or DN until “MODEL” flash , and then Press “ENT” key to enter Model Menu; Press UP or DN key until “SWASH” becomes flash. The available 1-NRM,2-180,3-120,3-140,3-90 options will flash after press ENT.

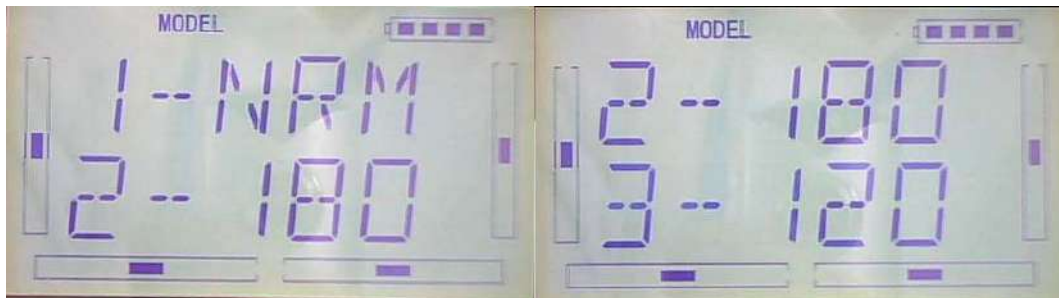

Press EXT to exit.

2.11 (AMPLI)

The transmission output power of DEVO-7 is adjustable. It is divided into six grades from small to big. The lower the transmission output power transmits, the shorter the radio range is, and the longer the stand-by time will be. The higher the transmission output power, the farer the radio range, and the shorter the stand-by time. Choose the appropriate transmission output power according to the actual situation

Setting method:

Press ENT,the flash main menu will be shown. Press UP or DN until the flash“ AMPLI” shown and then press ENT to enter the output power interface. Press UP or DN to choose the appropriate output power and it will flash, press ENT to confirm.

After the setting, press EXT to exit.



2.12 Fixed ID

This setting will bind DEVO-7 and its receiver in a unique corresponding relationship. It will greatly speed up the time of automatic binding when DEVO-8 powered on.

1) Setting for fixed ID

The setting for fixed ID should be under the status that automatic ID binding is successfully finished. Below is the setting method.

Press ENT, the flash main menu will be shown. Press UP or DN until the flash "MODEL" shown and then press ENT to enter MODEL menu. Press UP or DN until the "FIXED" flash. Press ENT to enter the status ON or OFF. Press R or L to choose ON and press DN to enter the fixed ID setting interface.

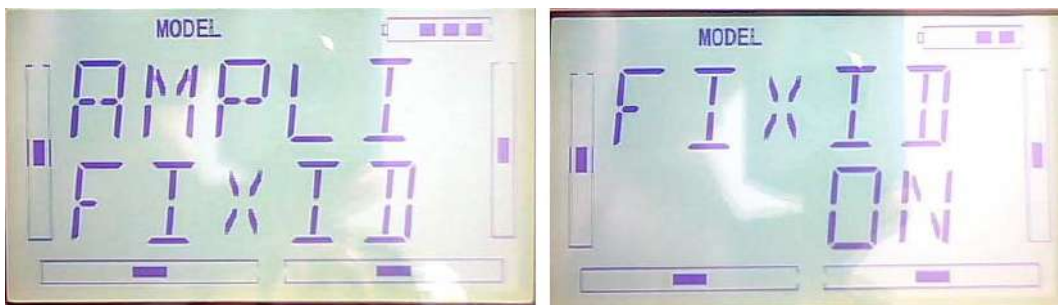

Press ENT, the digit can be modified will be flash. Press R or L to modify the digit. Press DN can modify the next digit. The RUN interface will be shown after press ENT. Press R or L to change the ON to YES and press ENT to enter the binding process. After binding, it will return to model menu automatically.

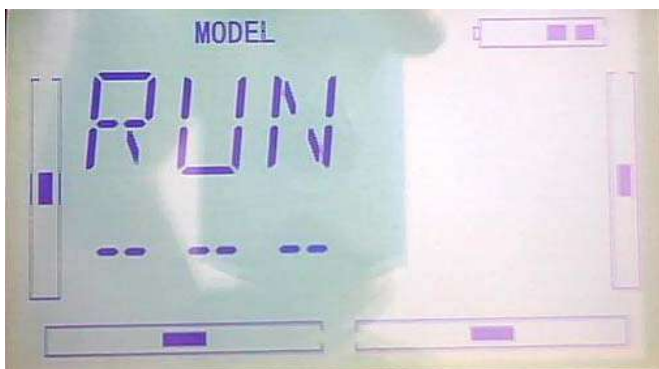
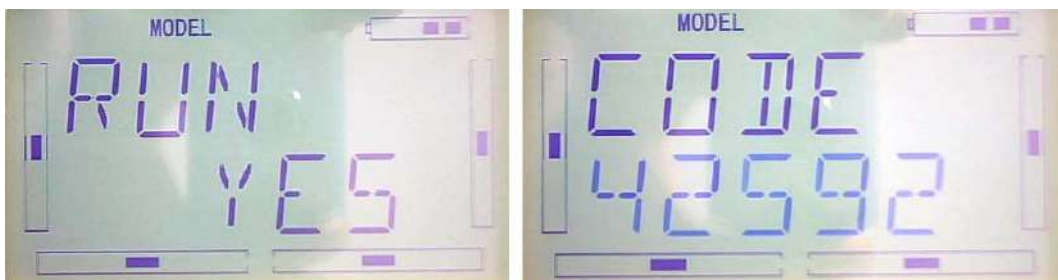

2) Fixed ID cancellation

Insert the assorted BIND PLUG into the output terminal of BATTER before the receiver is powered on, and then plug 5V DC power into one of the other output terminals. The red light of receiver will flash slowly. This means the fixed ID code has been cancelled. Pull out BIND PLUG.



DEVO-7 also needs to make relative cancellation and reversion after the fixed ID in receiver is cleared out.

Take the fixed ID setting method as a reference .Press UP when below interface shown.



Press R or L to change ON to OFF when below interface shown, and then press EXT to exit.

3.0 Function Menu

Function Menu can help you make **CUSTOM** adjustments for the selected models. The menu includes such items as Reverse Switch, Travel Adjust, Sub Trim, Dual Rate

and Exponential, Throttle Hold, Throttle Curve, Mix to Throttle, Gyro Sensor, Governor, Tail Curve, Dual Pitch, Swash Mix, Pitch Curve, Program Mix, Monitor, Fail Safe, Trainer, and Timer.

3.1 Reverse Switch

Press ENT to enter the flashing main menu, Press UP or DN to flash "FUNCTION", and then press "ENT" to enter Function Menu; Press UP or DN to flash "REVSW"; Press ENT, Channel Name and flashing normal or reverse state will be shown. Press R or L to change the NOR or REV state. Press DN, there are normal & reverse switches in turn for AILE, THRO, RUDD, GEAR, PITCH, GYRO and so on. The setting are the same as above, EXT it for finish.

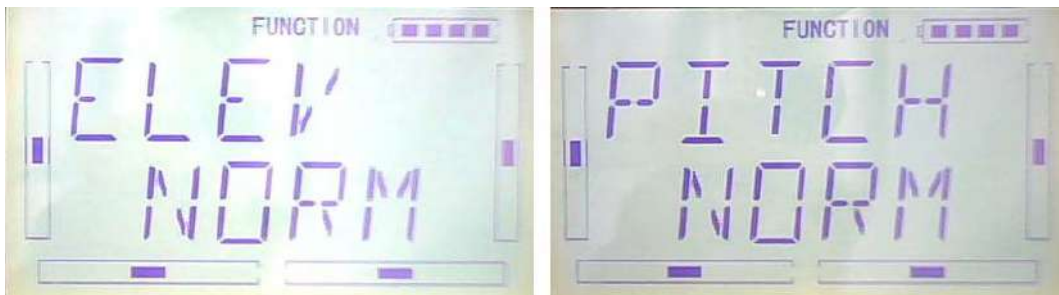

3.2 (Travel Adjust)

Press ENT to enter Main Menu, press UP or DN until "FUNCTION" flash, and then press ENT to enter Function Menu; Press UP or DN button to flash "TRVAD"; Press ENT button to enter the enactment options for channel names and flashing travel range. Press R or L to change the enactment value of travel range; Press DN button, there are travel range enactment options in turn for AILE, THRO, RUDD, GEAR, PITCH, GYRO and so on. The setting are the same as above, here we take the ELEV as example. EXT it for finish.

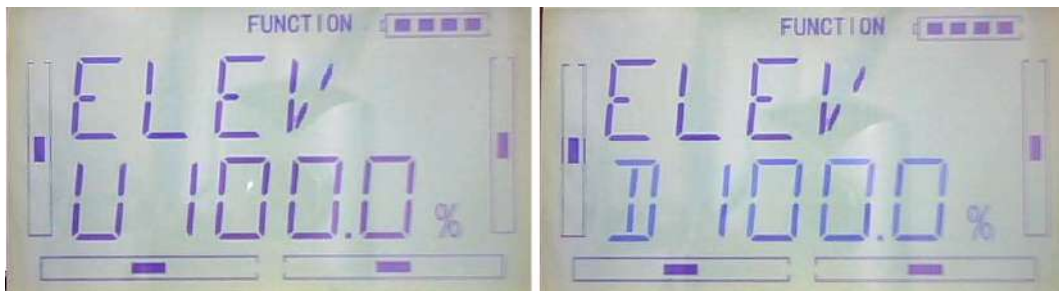

3.3 (Sub Trim)

Sub Trim is used to make parallel movement of the neutral point of the servo. But we advise you to mechanically adjust the servo bell crank if offset is far away from the neutral point of servo. Because servo would be damaged if excessive usage of the sub trim and beyond its range.

Setting: Press ENT to enter Main Menu, press UP or DN until "FUNCTION" flash, and then press ENT to enter Function Menu; Press UP or DN to flash "SUBTR"; Press ENT to enter the enactment options for channel names and flashing neutral point value. It is possible to change the neutral point setting value through R or L button, if the direction is reverse, change the sign "+" "-" before value. Press DN button, there are travel range enactment options in turn for AILE, THRO, RUDD, GEAR, PITCH, GYRO and so on. The setting are the same as above, here we take the ELEV for example.



Every channel default value is 0.0%. Adjust ranges as below:

Channel name	Adjustment range	Channel name	Adjustment range
Elevator	D62.5%-U62.5%	Gear	-62.5%- +62.5%
Aileron	R62.5%-L62.5%	Pitch	L62.5%- H62.5%
Throttle	L62.5%-H62.5%	Gyro	-62.5%- +62.5%

Rudder	R62.5%-L62.5%		
--------	---------------	--	--

EXT it for finish.

3.4 Dual rate and exponential

It is possible to use D/R switch to control over the dual rate of elevator, aileron, and rudder, after the function of Dual Rate and Exponential is setup. The setting range is 0-125%. Under the help with exponential curve adjustment, it is not only manually but also automatically able to set up various parameters which are suitable for yourself.

Under working with Flight Mode, it is possible to switch between the dual rate and exponential.

1) Channel selection

Setting method: Press ENT to enter Main Menu. Press UP or DN to flash "FUNCTION", and then press ENT to enter Function menu; Press UP or DN until "DREXP" blink; Press ENT to enter the options for Channel names. Press R or L, there is a selectable list for ELEV, AILE, RUDD. Here we take the ELEV for example. The picture as below:



2) Position selection

Press DN to enter Switch Position setting in the above Picture, there are POS0, POS2, POS3. Press R or L, it is possible to choose POS0, POS1, POS2, POS3.



The D/P Switch Position on transmitter



3) Dual Rate adjustment

After setup the position, press DN to enter D/R enactment interface, press R/L to adjust D/R value.



4) Exponential adjustment

After setup the Dual Rate, Press DN to enter EXP setting interface, there are Line and adjustable value, 2 setting options. Press R or L to choose.

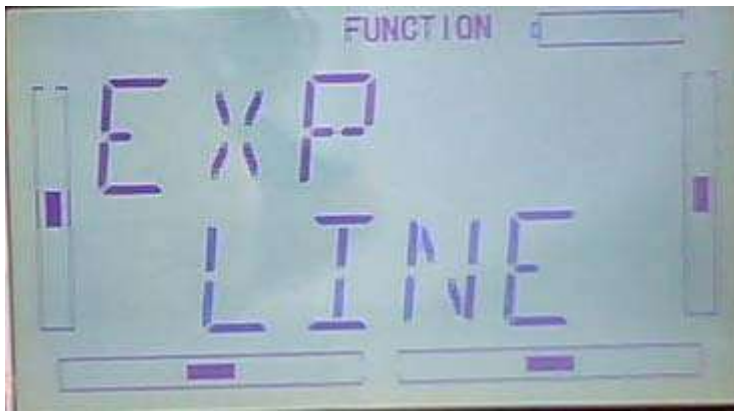

5) Automatic setting

Under working with Flight Mode, it is possible to switch between the dual rate and exponential, which are set in above 3) Dual Rate adjustment and 4) Exponential adjustment, respectively.



The settings for Normal Flight, Stunt Flight 1, Stunt Flight 2, Throttle Hold are available. The Throttle hold state should be “activated” (Refer to aftermentioned”3.5” Throttle Hold) in “Throttle Hold”, under “Function Menu”.

After setup the Exponential adjustment, press DN to enter NORM setting interface, Press R or L to flash “SWITC” (switch), there are options for POS0,POS1,POS3,POS3. Press R or L to blink the desired option.



After setup NORM mode, Press DN to enter ST1 setting interface, the setting method as the same as above.



After setup ST1 mode, Press DN to enter ST2 setting interface, the setting method as above.



If the Throttle Hold is activated, it appears Throttle Hold option as below,

After setting ST2 Mode, Press DN to enter THHLD setting interface, the setting method as above.



Ext it to finish.

3.5 Throttle hold

If this function is activated, the switch will be executed by hold switch. The setting value of throttle hold is ranged from -20.0 to 50.0%. The default setting is "Inhibited".

Setting method:

Press ENT to enter the Main Menu. Press UP or DN until "FUNCTION" flash, and then press ENT to enter Function Menu; Press UP or DN to blink "THHLD"; Press ENT to enter the display of Throttle Hold states. Press R or L , ACT (activated) or INH (Inhibited) is available. Factory default setting is Inhibited.



If throttle Hold is activated, "Throttle Hold Position" Menu will be shown in the Interface.

"Throttle Hold Position" setting

Throttle Hold is activated, press DN to enter the interface as below:



Press R or L to change the Hold value. The minimum value is -20.0%; The maximum value is +50.0%.



The Throttle Hold Switch “HOLD” forward is to “start”, the Throttle Hold Switch “HOLD” backward is to “close” and then Throttle Hold state is dismissed.

EXT it to finish.

3.6 Throttle Curve

Press ENT to enter the flashing Main Menu. Press UP or DN until “FUNCTION” flash, and then press ENT to enter Function Menu; Press UP or DN to blink “THCRV”; Press ENT to enter the interface of Servo Hold State, Press R or L to choose YES or NO. Press ENT to confirm.

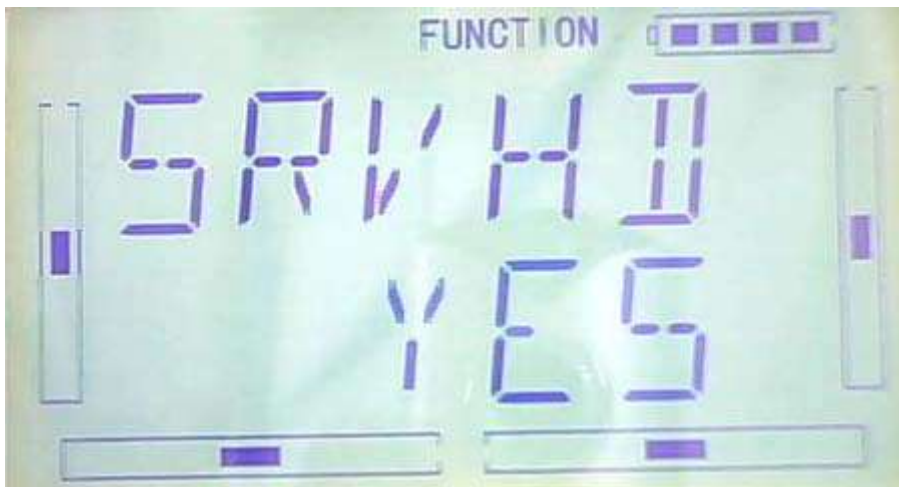

Flight Model options will be shown in the interface, there are NORM, ST1, ST2.

Every flight mode curve that can be set separately.

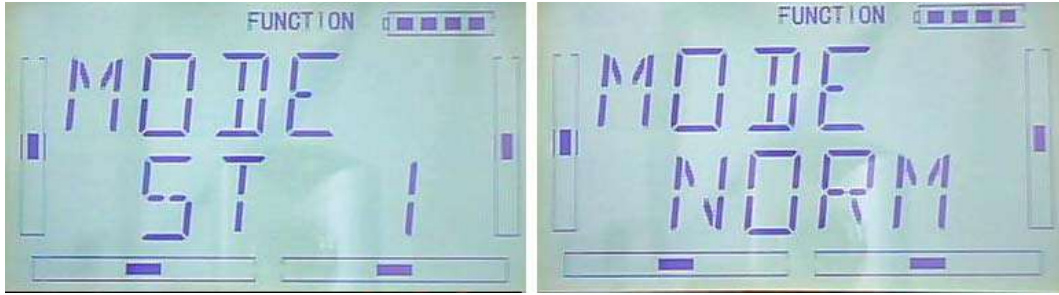

Press R or L to choose the desired flight mode.

Press DN, the EXP on or off option will be shown. Press R or L to choose ON or OFF.



Press DN, the 7 point options will be shown, then press R or L to choose one of 7 points, There are L、1、2、3、M、4、5、H for option. Press DN button, the output can be set and then press R or L to set the output amount.



Press UP to return after the setting, then choose other point to set. Press EXT to exit after the settings finished.

3.7 Mix to throttle

This function can keep the main rotor blades running at the certain revolution caused by the changed load when operating the aileron servo, elevator servo, and rudder servo. It is just used for stunt flight. Generally, It is not advised to use this function. Setting method:

Press ENT to flash Main Menu. Press UP or DN to blink "FUNCTION", and then press ENT to enter Function Menu; Press UP or DN until "MIXTH" flash; Press ENT to enter Channel Option Interface; there are ELEV, AILE, RUDD available.

1. Channel setting

Press R or L to choose the channel ELEV that need to be set.



After chose the ELEV channel, press DN to enter Switch setting interface, it would be shown as below:

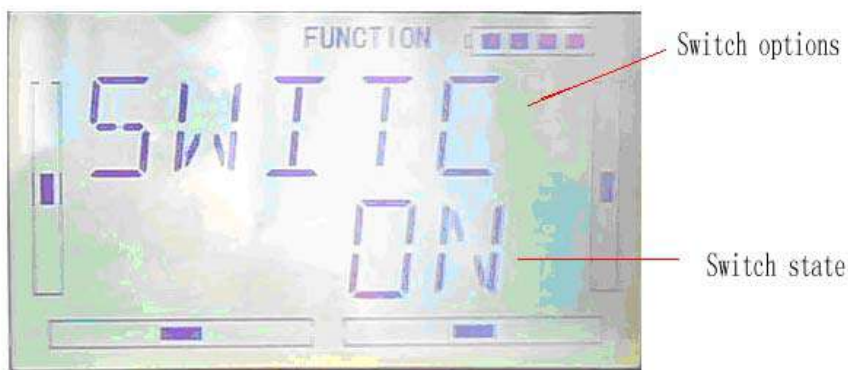

2) Switch option

In above interface, Press ENT to enter Switch options and Switch state. There are Switch options including ALLON (always on), NOR (normal mode), ST1(stunt 1), ST2(stunt2), Gear.

ALLON(always on) option: It will be default always on if NOR (normal mode) or

ST1(stunt 1) or ST2(stunt2) or Gear switch option is activated, but this is inhibited automatically.



After setting ALLON (always on) option, press DN to enter NOR(normal mode) Switch setting interface, press R or L to set the Switch activated or inhibited.



After setting NOR(normal mode) option, press DN to enter ST1 (stunt1) switch setting interface, press R or L to set switch activated or inhibited.



After setting ST1(stunt1) option, press DN to enter ST2 (stunt2) switch setting interface, press R or L to set switch activated or inhibited.



After setting ST2(stunt2) option, press DN to enter GEAR switch setting interface, press R or L to set switch activated or inhibited.



3)UP setting

After Switch option setting finished, press EXT to back Switch Option, the picture as below:

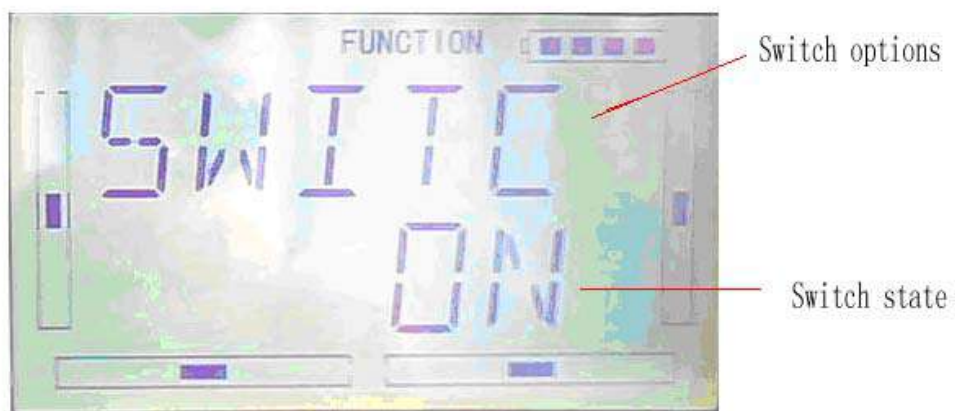

Press DN to enter Up setting interface and adjustable value option.

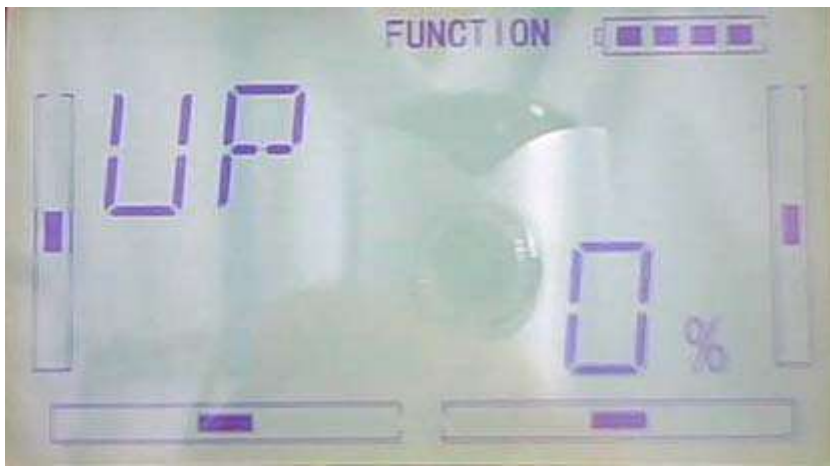

Press L button, Mix value is adjustable that means Mix value will increase when forward push elevator rocker. The bigger of value, the bigger of Mix; Press R to get negative value if you want reverse the direction of Throttle and Mix. Adjustable range is $\pm 125\%$.

4) Down Setting

After setting UP option, Press DN to enter DOWN setting interface.



Press L button, Mix value is adjustable that means Mix value will decrease when backward pull elevator rocker. The bigger of value is, the bigger of Mix gains; Press R to get negative value if you want reverse the direction of Throttle and Mix. Adjustable range is $\pm 125\%$.

5) The setting method is the same as above when "Channel" option displays "Aileron" or "Rudder". Press EXT to finish.

Tips:

- 1) Please make sure the above setting value for Mix & Throttle is good for ideal flight and the action in various flight modes are normal.
- 2) The function is in spare when governor is working.

3.8 GYRO SETTING

Press "ENT" button to enter Main Menu, press UP or DN until "FUNCTION" flash, and then press "ENT" button to enter function Menu. Press UP or DN until "SWHMX" becomes flash. Press ENT to get the Mode option interface. Press R or L, to choose Manual setting or Automatic setting.



1) Manual Setting:

Press R or L to choose Manual setting, Press ENT button to enter SWITC MIX interface, Press R or L to choose the desired Switch, MIX is the default switch.

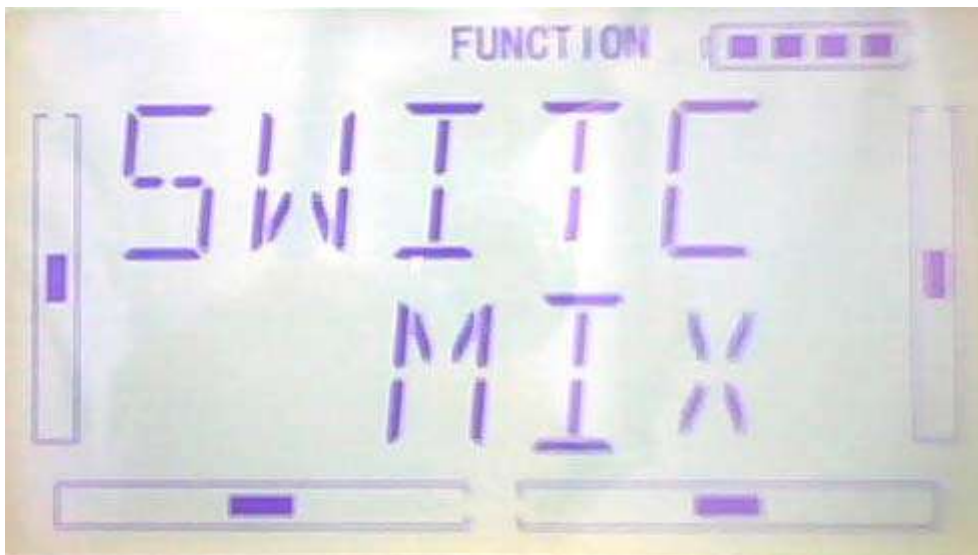

Press DN to enter SWITC POSITION DATA interface, the initial position is 0. Press R or L to change value. The gyro you use owns two modes of AVCS and NOR, AVCS will be activated when the amount is above 50.0%. The bigger the amount is, the bigger the gyro sensor gain becomes. If the value less than 50, it's NOR mode. The smaller the amount is, the bigger the gyro sensor gain becomes.



After POS 0 setup, please press DN to continue set the POS1 or POS2, which the steps are the same as POS 0. Press EXT to finish.

2) Automatic setting

After gyro auto setup, The position range is mutative according to the flight MODE

Press R or L to choose AUTO under MODE option interface.



Press DN to enter the auto setting NORM mode, press R or L to set the amount. The gyro you use owns two modes of AVCS and NOR, AVCS will be activated when the amount is above 50.0%. The bigger the amount is, the bigger the gyro sensor gain becomes. If the value less than 50, it is NOR mode. The smaller the amount is, the bigger the gyro sensor gain becomes.



Press DN to enter ST1 and ST2 after finish, setting steps are the same as NORM MODE setting

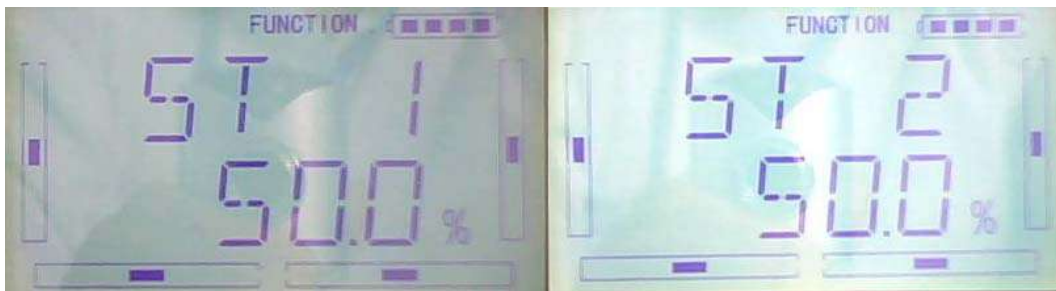

Press EXT to finish.

3.9 Governor

Before setup this function, "Governor" should be set and activated in "Device output" interface. (Refer to 2.9 Device Output)

It is possible to set Governor control rate in various flight modes separately. Please setup the Governor for the desired rotation speed. The transmitter display data is only for percentage reference. The real rotation speed refer to Governor.

Press "ENT" key to enter Main Menu, press UP or DN until "FUNCTION" flash , and then Press "ENT" key to enter Function Menu; Press UP or DN button until "GOVER" becomes flash. Press ENT to enter the interface of MODE Menu and adjustable Value options. There are "Normal mode", "ST1", "ST2", "Throttle Hold" 4 options available.

NORM setting: The picture as below. Press R or L to set the value. Press R to decrease, the minimum is -125%; Press L to increase, the maximum is +125%.



ST1 setting: After setup the NORM option, press DN to enter ST1 setting interface. Press R or L to set the value. Press R to decrease, the minimum is -125%; Press L to increase, the maximum is +125%.

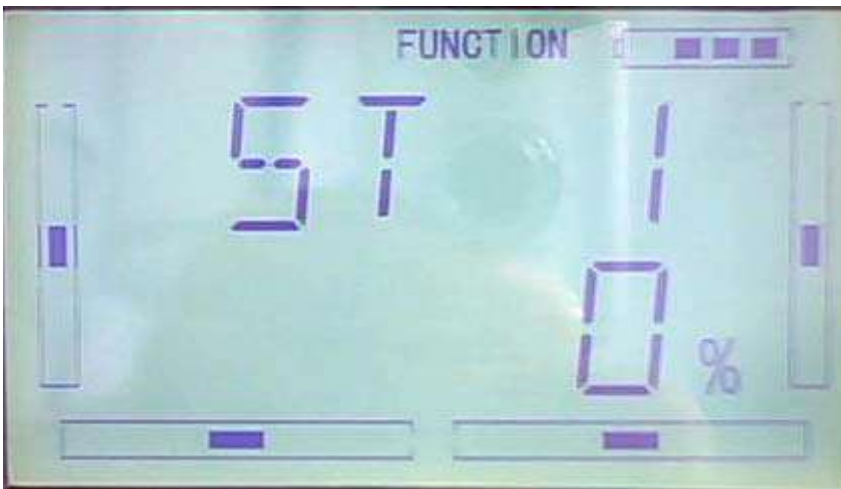

ST2 setting: After setup the ST1 option, press DN to enter ST2 setting interface. Press R or L to set the value. Press R to decrease, the minimum is -125%; Press L to increase, the maximum is +125%.



THHLD setting: Throttle Hold should be activated. After setup the ST2 option, press DN to enter THHLD setting interface. Press R or L to set the value. Press R to decrease, the minimum is -125%; Press L to increase, the maximum is +125%.



Press EXT to finish.

3.10 SWASH MIX

This function is to adjust the swash mix during the flights. It will only be affected when the swash type is 2 servos or above (refer to 2.12 swash type).

Setting Method:

Press “ENT” button to enter Main Menu, press UP or DN until “FUNCTION” flash, and then press “ENT” button enter function Menu. Press UP or DN button until “SWHMX” becomes flash. Press ENT button to get the setting items and value adjustment interface. Take 3 servos 120° for example, there are 4 items including AILE,EEV,PITCHS and EXP are adjustable.

1) Aileron Mix Adjustment

Under flashing “ SWHMX” menu, press ENT button to go to the AILE Mix Adjustment interface. Press R button to reduce the mix and L button to increase. If the mix directions are opposite, it is possible to reverse mix direction through R or L button to change the plus or minus sign before

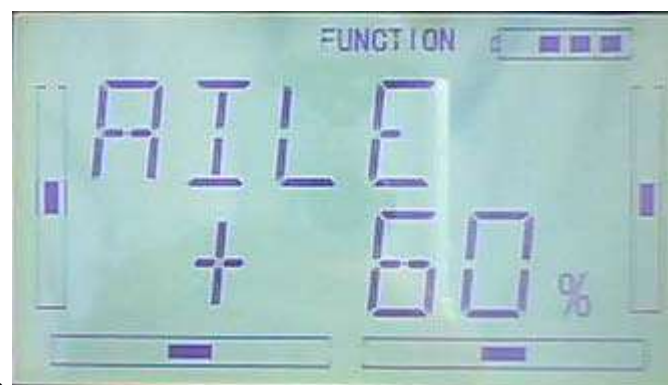

amount. The adjustable range is $\pm 125\%$.

2) Elevator mix adjustment

After AILE mix setting complete, press DN button until get ELEV mix setting interface. If the “swash type” is 3 servos or more (refer to “2.12 Swash Type”), the setting is the same as above.



3) Pitch Mix Adjustment

If the “swash type” is 2 servos or more (refer to “2.12 Swash Type”), the setting is the same as above.



4) Exponential Curve

When the function is ON, the dual rate is adjustable in the “Dual rate and exponential” under “function menu”.

Setting Method: After PITCH mix setting complete, press DN button to get into EXP setting interface. Press R or L button to get “ON” and “OFF” options. The default setting is “OFF”, but it is suggested to be “ON”.



After the setting, press EXT to exit.

3.11 Pitch Curve

Pitch curves are adjusted through 7 points, which of all the flight modes can be respectively set. There are “normal flight”, stunt flight 1, stunt flight 2 and “throttle hold” 4 flight modes.

Setting Method:

Press ENT to flash main menu. Press UP or DN key, FUNCTION will flash and then press ENT to enter function menu. Press UP or DN, “PTCRV” will flash, press ENT to enter the interface of servo hold , press R or L to choose YES or NO. then press ENT to confirm.



There are “normal flight”, stunt flight 1, stunt flight 2 and “throttle hold” 4 flight modes. The curve of each flight mode can be set respectively.

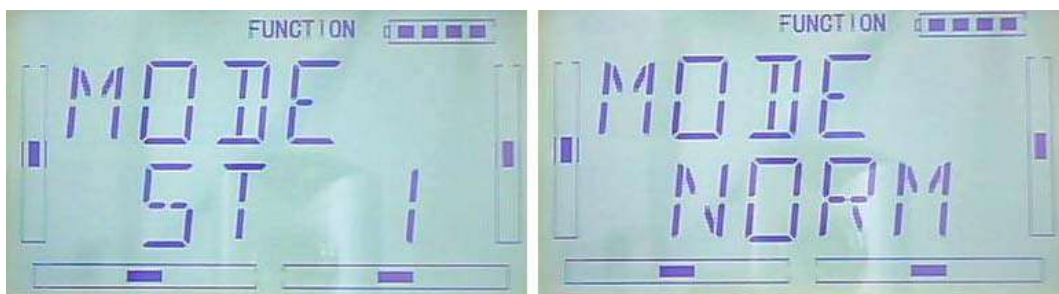

Press R or L button to choose the required flight model.

Press DN button to get the EXP ON or OFF option. Press R or L button to choose ON or OFF.

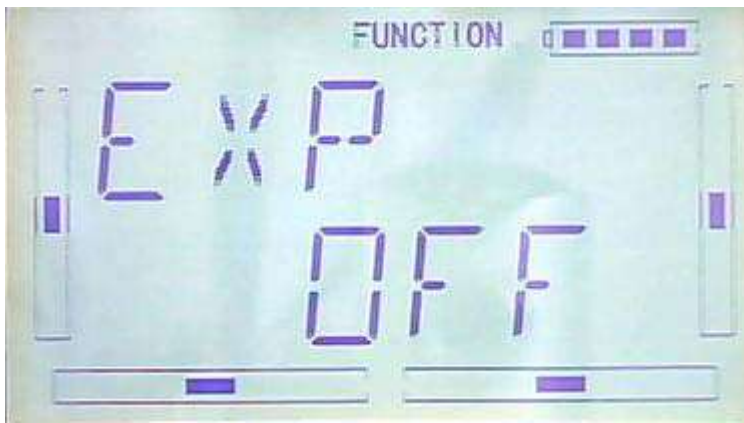

Press DN, the 7 point options will be shown. Press R or L to select any point from L, 1, 2, M, 4, 5 and H7. Press DN key, the output can be set and then press R or L to set the amount.



Press UP to return, and continue to set other points. Press EXIT after the settings.

The basic examples are only for your reference. Adjustment to the real flights is a must.

Normal

Flight Mode: Normal

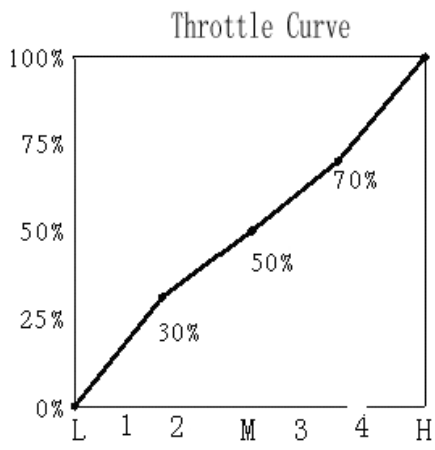

Throttle Curve

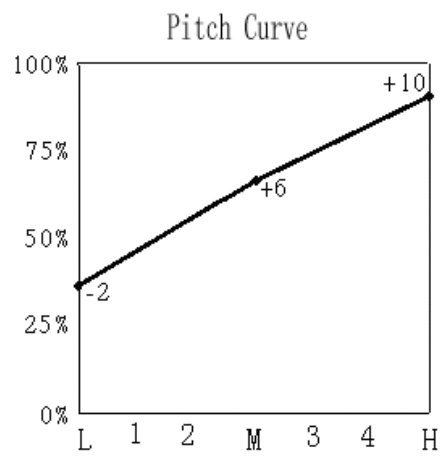

Pitch Curve

Flight Mode 1

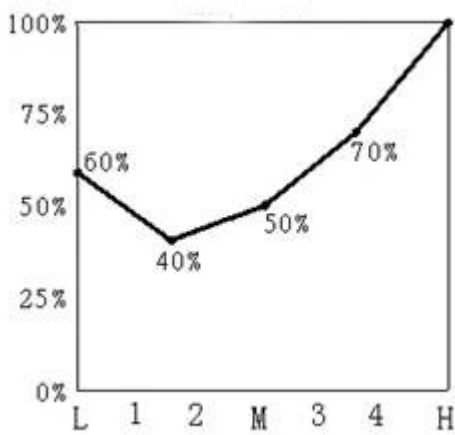

Throttle Curve

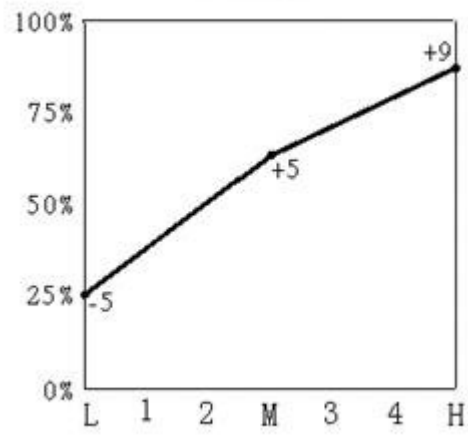

Pitch Curve

Flight Mode 2

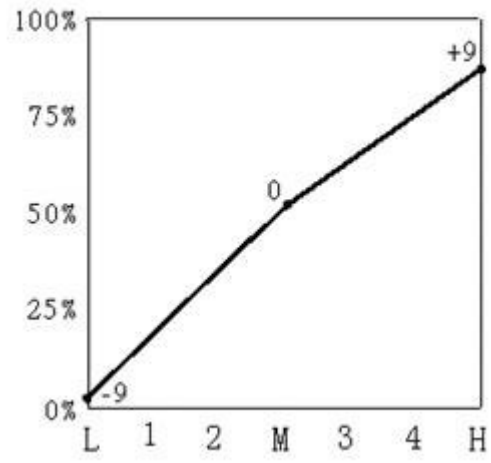
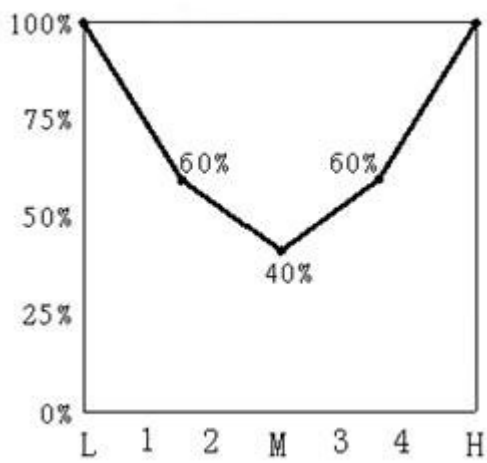

Autoration Landing

Pitch Curve

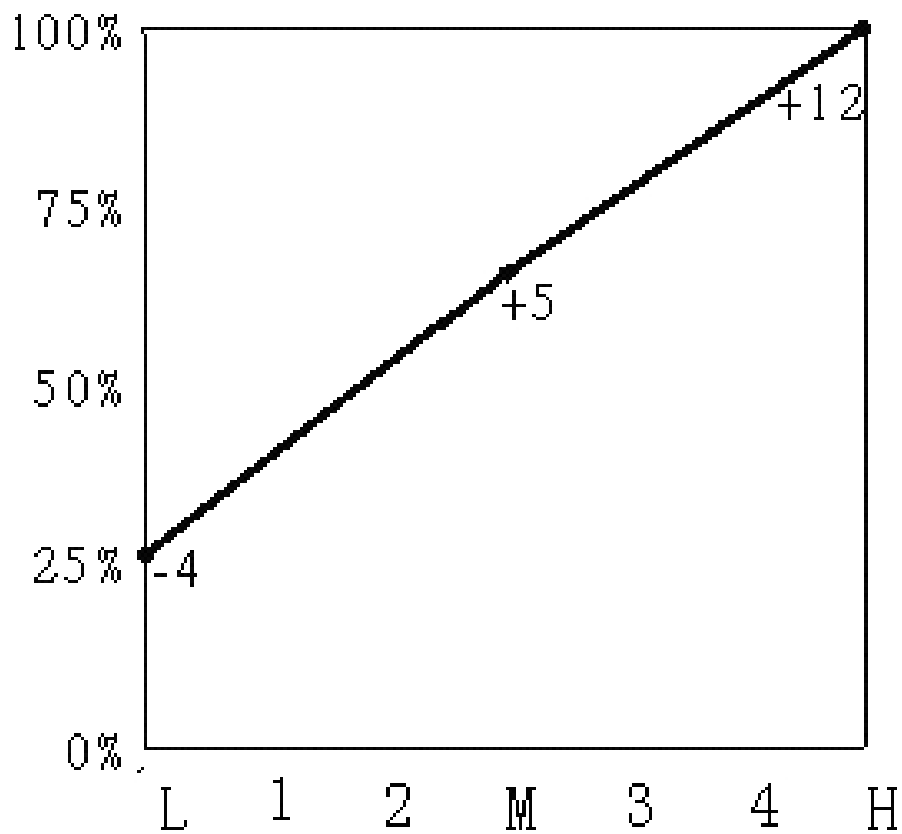

3.12 Program Mix

There are 8 series of program mix, mix channels and values are adjustable.

Setting Method:

Press ENT to flash main menu. Press UP or DN, FUNCTION is flashing, press ENT to enter function menu, then press UP or DN to flash "PRGMX". And press ENT to program mix setting and current status (default setting is "inhabit") interface. Press R or L to choose inhibited, normal or curve.

Take "program mix 1" for example, there are "normal" and "curve" setting.



A the "normal" setting of "program mix"

◦

Press L button to get into the normal setting interface.



Press ENT button then expand an enquiry "All Servos Hold?" Press R or L to choose YES or NO. If "YES" selected, all the servos will be locked in the current status, if "NO" selected, all servos are unlocked.



Press ENT button to get program mix 1 setting interface. There are adjustments including main channel, slave channel, gain, offset and switch, etc.

1) Setting of main channel: See below interface, press R or L to choose the required main channel among ELEV, AILE, THRO, RUDD, GEAR, PITCH, AUX2, OELEV, OAILE, OPITC, ORUDD, PELEV, PAILE, PTHRO, PRUDD and FMOD.



2) Setting of slave channel: after the setting of main channel finished, press DN button. When getting to below interface, choose the required slave channel among ELEV, AILE, THRO, RUDD, GEAR, PITCH and GYRO.



3) Setting of Gain: Take Elevator as main channel as an example. Press DN button

after slave channel is set, then get to gain setting interface.

3.1) Mix amount setting when elevator stick moved upward:

Press R to decrease the mix amount and press L to increase. It is possible to reverse mix direction by pressing R or L button to change the plus or minus sign before amount. The adjustable range is $\pm 125\%$.



3.2) Mix amount setting when elevator stick moved downward:

Press DN button after the above setting is finished. Press R to decrease the mix amount and L to increase. It is possible to reverse mix direction by pressing R or L button to change the plus or minus sign before amount. The adjustable range is $\pm 125\%$.

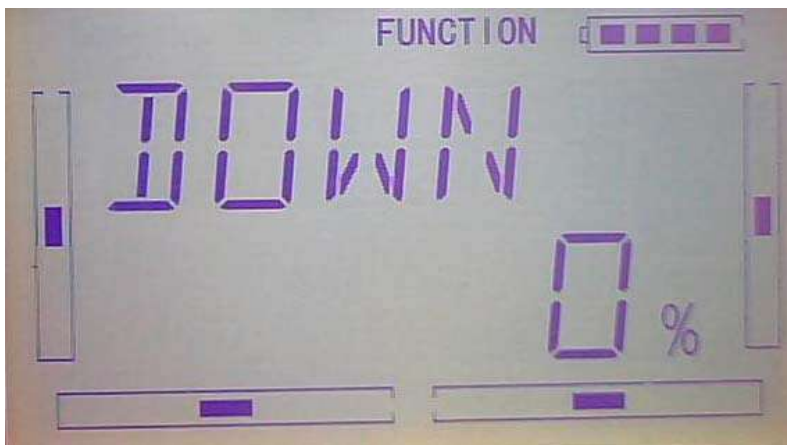

3.3) Offset Setting: it can be started from any position in "slave channel" through related switch.

After mix amount setting when elevator stick moved downward finished, press DN button to get to Gain Setting Interface. Press R to decrease the mix amount and L to increase. It is possible to reverse mix direction through changing the plus or minus sign before amount. The adjustable range is $\pm 100\%$.



3) Switch: After setting Gain, press DN button to get to switch setting interface and shown current status. Press ENT button to the switch setting including all on, normal mode switch, ST 1 switch, ST 2 switch, D/R switch, HOLD switch and GEAR switch.

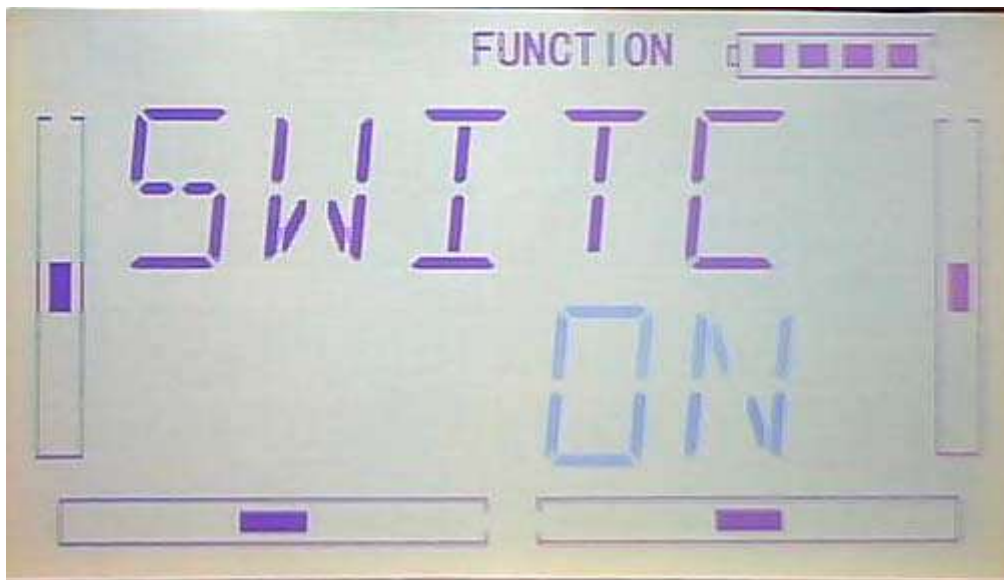

ALLON (always on): if normal mode switch, ST 1 switch, ST 2 switch, D/R switch, HOLD switch and GEAR switch are all active, then this switch is inhibited. The default setting is ALL ON.



After setting ALLON (always on), press DN button to get to NOR (normal flight) switch setting interface. Press R or L to set the switch inhibited or active.



After setting NOR (normal flight), press DN button to get to ST 1 (Stunt flight 1) switch setting interface. Press R or L to set the switch inhibited or active.



After setting ST 1 (Stunt flight 1), press DN button to get to ST 2 (Stunt flight 2) switch setting interface. Press R or L to set the switch inhibited or active.



After setting ST 2 (Stunt flight 2), press DN button to get to D/R switch setting interface. Press R or L to set the switch inhibited or active.

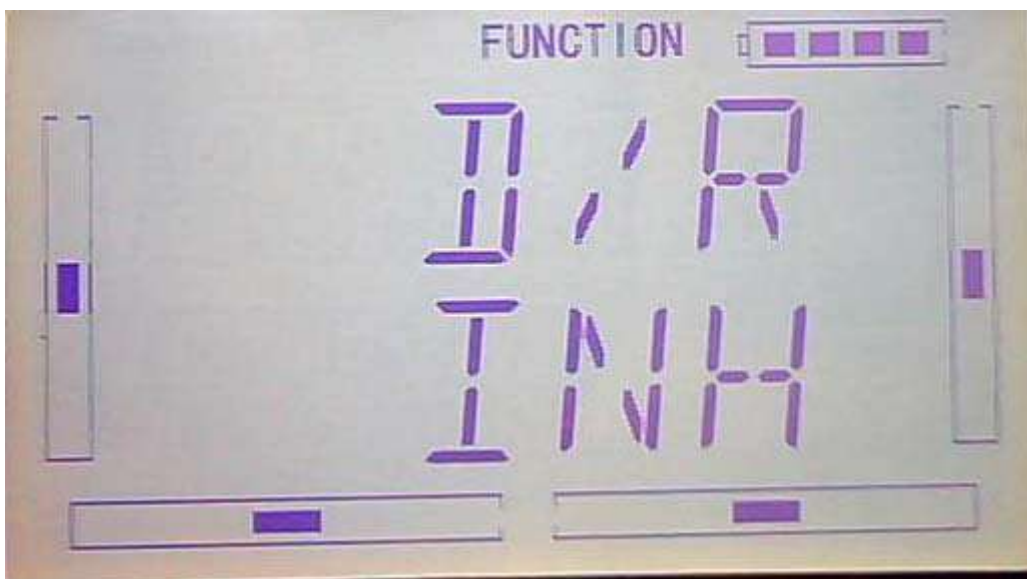

After setting D/R, press DN button to get to HOLD switch setting interface. Press R or L to set the switch inhibited or active.

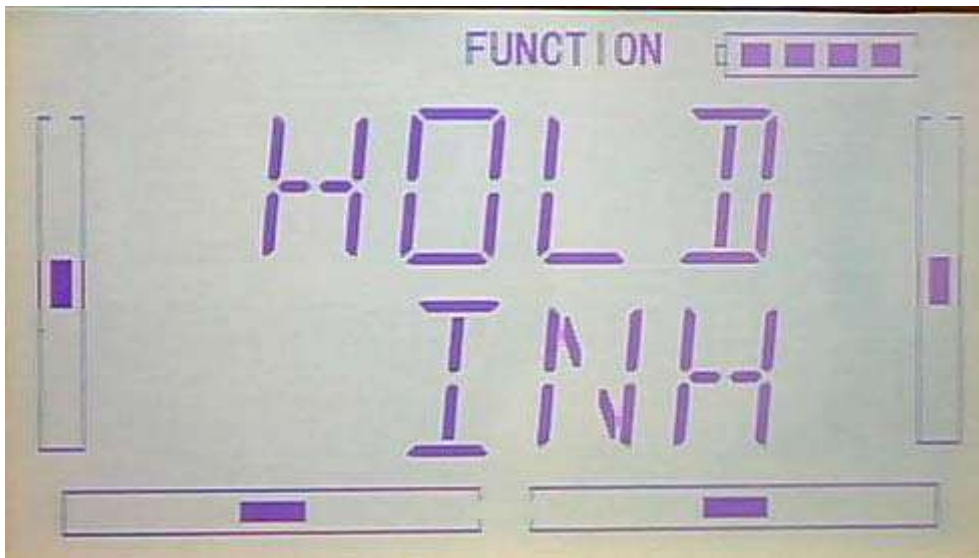

After setting HOLD, press DN button to get to GEAR switch setting interface. Press R or L to set the switch inhibited or active.



After finished, press EXT to exit.

:

B "Curve" setting of "Program Mix"

Press ENT to flash main menu. Press UP or DN, FUNCTION is flashing, press ENT to enter function menu, then press UP or DN to flash "PRGMX" . and press ENT to program mix setting and current status (default setting is "inhabit") interface. Press R or L to choose inhibited, normal or curve.

Take "program mix 1" for axample, and choose "curve" setting.



Press ENT button then expand an enquiry "All Servos Hold?". Press R or L to choose YES or NO. If "YES" selected, all the servos will be locked in the current status, if " NO" selected, all servos are unlocked. Press ENT button to get program mix 1 setting interface.

1) Setting of main channel: See below interface, press R or L to choose the required main channel among ELEV, AILE, THRO, RUDD, GEAR, PITCH, AUX2, OELEV, OAILE, OPITC, ORUDD, PELEV, PAILE, PTHRO, PRUDD and FMOD.



2) Setting of slave channel: after the setting of main channel finished, press DN button. When getting to below interface, choose the required slave channel among ELEV, AILE, THRO, RUDD, GEAR, PITCH and GYRO.

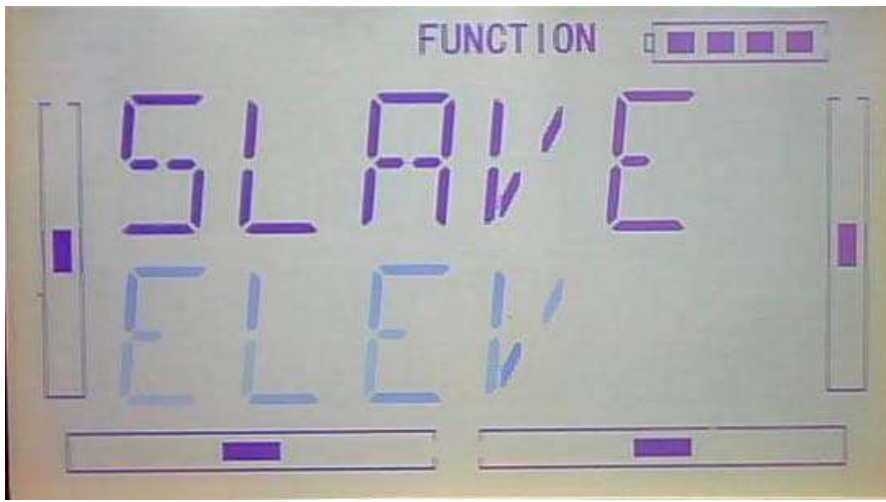

3) Exponential curve: after setting the slave channel, press DN button to get to the EXP setting. When getting to below interface, press R or L to choose from EXP "ON" or "OFF". The pitch curve will be smoothly changed if choosing On. Otherwise choosing Off.



4) Point setting: Press DN, the 7 point options will be shown. Press R or L to select any point from L, 1, 2, M, 4, 5 and H7.



Press DN to get to setting status.

5) State setting: See below interface, press R or L to choose from “ Inhibited” or “ Active”. If no changes, choose Inhibited (the default setting is Inhibited); choose Active for changing the amount.

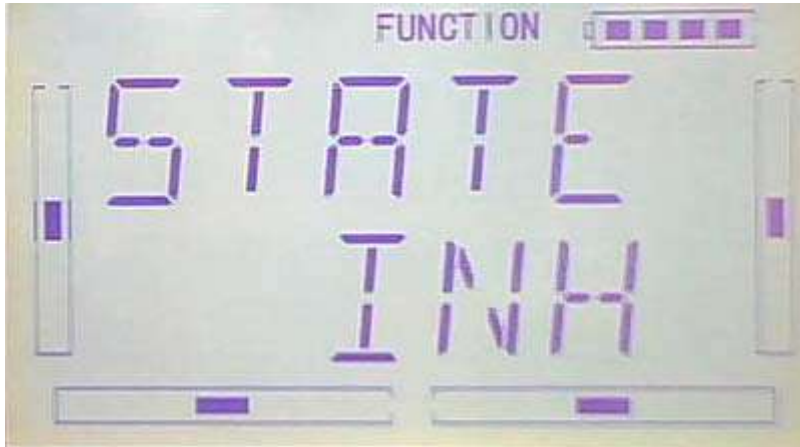

Press DN button to get to output setting.

6) output setting: See below interface, press R to decrease the output amount to minimum -100%; press L to increase the output amount to maximum +100%.

It is possible to reverse mix direction by pressing R or L button to change the plus or minus sign before amount.



7) Switch: after finishing output setting, press DN button then get to Switch setting interface and the current switch status will be shown.

Press ENT button to get the switch setting including ALLON, normal mode switch, ST 1 switch, ST 2 switch, D/R switch, HOLD switch and GEAR switch.

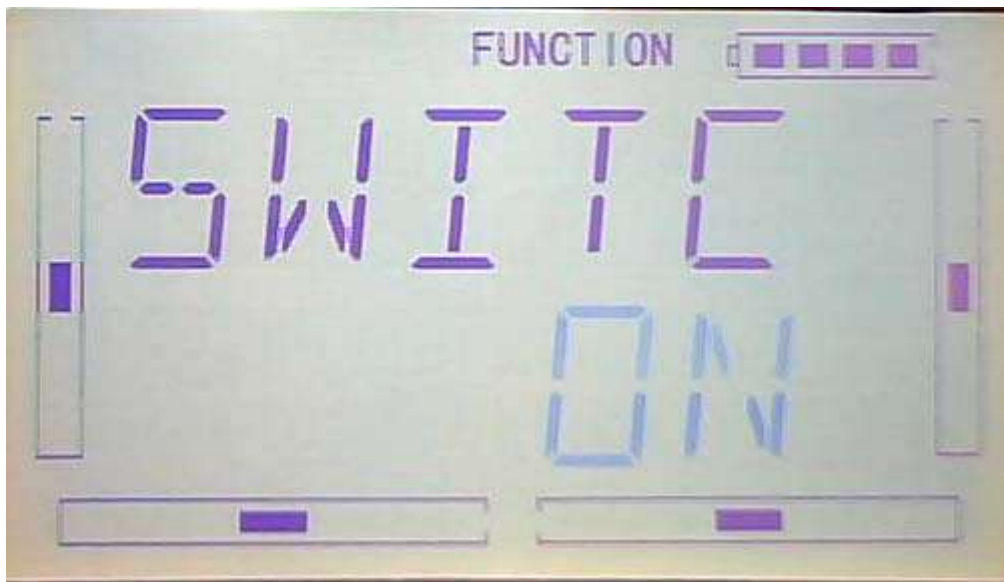

ALLON (always on): if normal mode switch, ST 1 switch, ST 2 switch, D/R switch, HOLD switch and GEAR switch are all active, then this switch is inhibited. The default setting is ALL ON.



After setting ALLON (always on), press DN button to get to NOR (normal flight) switch setting interface. Press R or L to set the switch inhibited or active.



After setting NOR (normal flight), press DN button to get to ST 1 (stunt flight 1) switch setting interface. Press R or L to set the switch inhibited or active.



After setting ST 1 (stunt flight 1), press DN button to get to ST 2 (stunt flight 2) switch setting interface. Press R or L to set the switch inhibited or active.



After setting ST 2 (stunt flight 2), press DN button to get to D/R switch setting interface. Press R or L to set the switch inhibited or active.

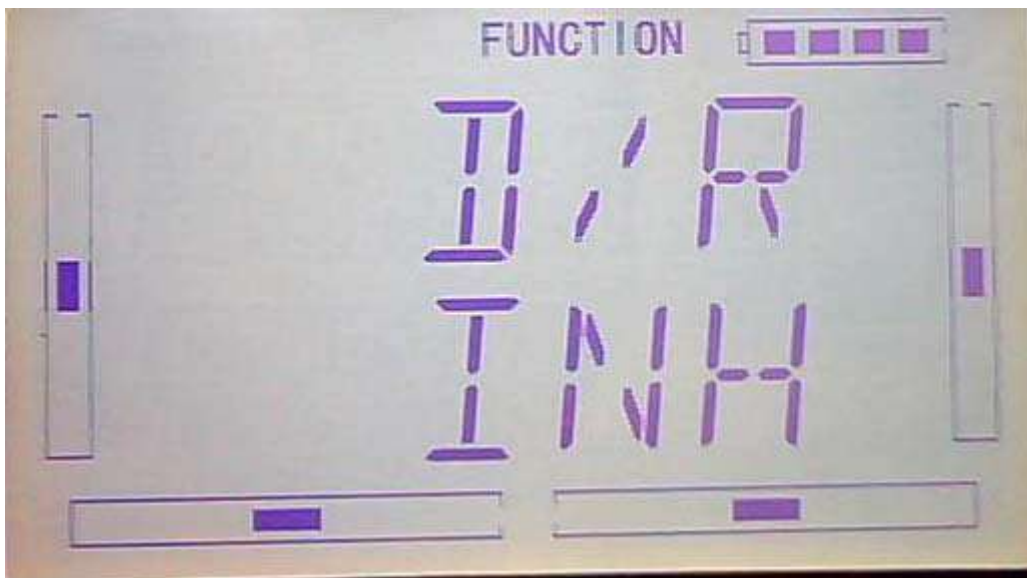

After setting D/R switch, press DN button to get to HOLD setting interface. Press R or L to set the switch inhibited or active.

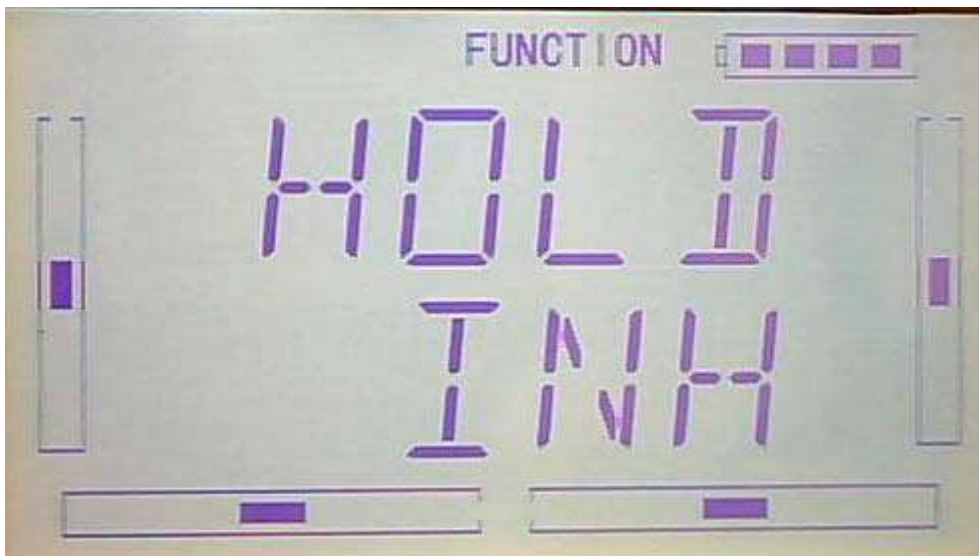

After setting HOLD switch, press DN button to get to GEAR setting interface. Press R or L to set the switch inhibited or active.



After finished, press EXT to exist.

3.13 (MONIT) Monitor

This function can display the current statuses and positions of all the channels' outputs, and check the current working status of each channel.

Press "ENT" button to enter flashing Main Menu, press UP or DN until "FUNCTION" flash, and then press "ENT" button enter function Menu. Press UP or DN button until "MONIT" becomes flash. Press ENT button to get the name of ELEV channel and output display. Press R or L to check other channels' name and output.

channel name

Output display

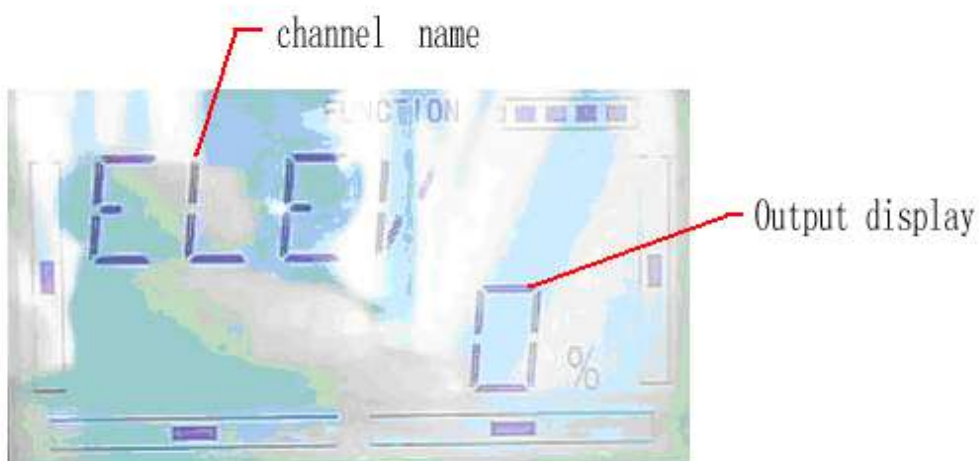

After finished, press EXT to exist.

3.14 Fail safe

There are two possibilities for use if the transmitter signal is under abnormal condition, the first one is lock the last action date received; the second one is to execute the pre-set date which is pre-set. The default setting is Servo Hold

setting method:

Press ENT to enter flash main menu. Press UP or DN until FUNCTION flash, repress ENT flash to enter function menu; press UP or DN until SAFE flash; press ENT to FAIL SATE setting interface. There are ELEV, AILE, THRO, RUDD, GEAR, PITCH, GYRO 7 channel setting. Take the item Elevator as an example to explain.



On above interface, press R or L to select keep or fail safe. If selecting keeping, locking the last dated received; If selecting fail safe, to execute the pre-set date which is pre-set. The default setting is Servo Hold

Press R to SAFE, press DN to enter fail safe date interface



Press R or L(if servo keep neutrally,etc 0%),to decrease or increase the position amount which centers on the neutral point of servo.The settable range is 125%,and 0% is the servo's neutral position.

Setting finishing DN to set other channel.

The setting methods for other channels are the same as above

Press EXT to exit after finished

Note: checking whether all the actions when fail safe happened correct is a must after the setting is finished.It is dangerous to use full throttle,especially after fail safe taken place

3.15 (TRAIN)

Two DEVO-7 transmitters working together can execute the training function to meet the requirements for the beginner. The setting method is shown as below:

1) Data copy

Using the wireless copy function of the two DEVO-7 transmitter, the model saved in the trainer's transmitter can be transmitted to the trainee's to ensure the model parameters are exactly same.

2) Linkage

Insert the signal wire from the trainer's transmitter into the DSC socket of the trainee's transmitter. Turn on the transmitter and a linkage icon will be shown on the boot screen. Showed as following interface.Find out the trainee's model data.



linkage icon

Turn on the power of the trainer's transmitter,find out the trainee's date and let the trainer's devo 7 fly the aircraft normally. After testing flying normal, insert one end of the signal wire into DSC socket at the rear face o the trainer's.



3) Setting fro training function channels

By setting training function channels, trainee can obtain all or parts of operation rights of designated channel function. The following is setting method.

Press ENT to show flash main menu. Press UP or DN to flash FUNCTION, repress ENT to enter function menu; Press UP or DN to untill flash TRAIN menu, press ENT to channel selection. Press UP or DN, select controlled channel, press R or L to change channel controlled right, INT for forbidden; ACT for granting. Press EXT to exit after finishing setting.



4) usage method

The training switch should be worked with HOLD/TRN, as following

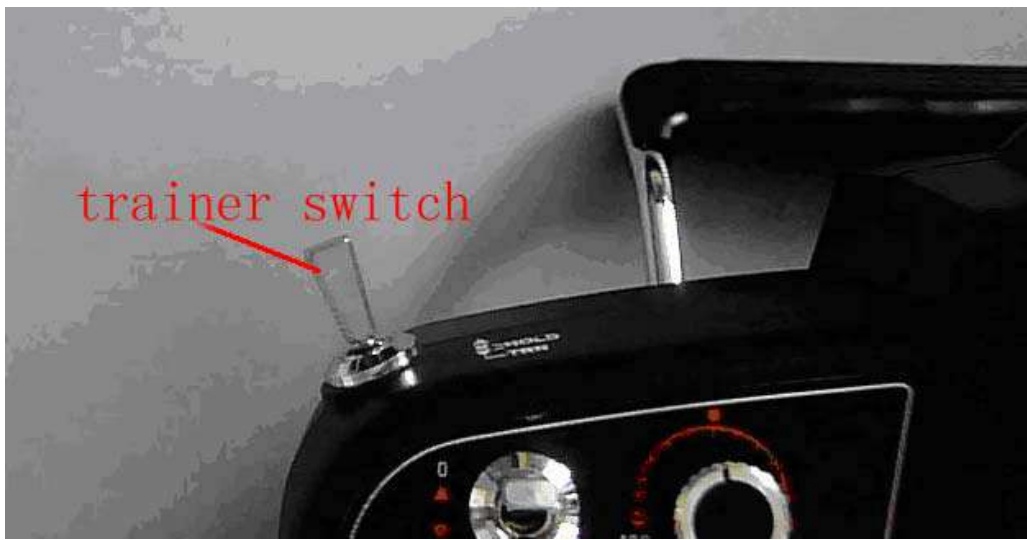

During flying, if trainer pull TRN front and keep it, that means trainer already hand over the controlled right to trainee. At the same time, the output date of open interface should be the operated data of trainee. If trainer move away TRN, that means trainer will get back the operated right from trainee and operate the model.

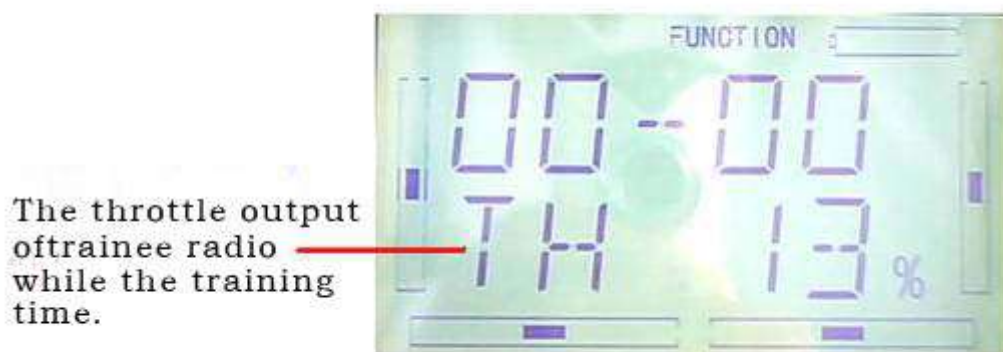

The throttle output of trainee radio while the training time.

3.16 (TIMER)

There are two timers which can be set stopwatch and countdown, respectively. Each timer can be operated by switch.

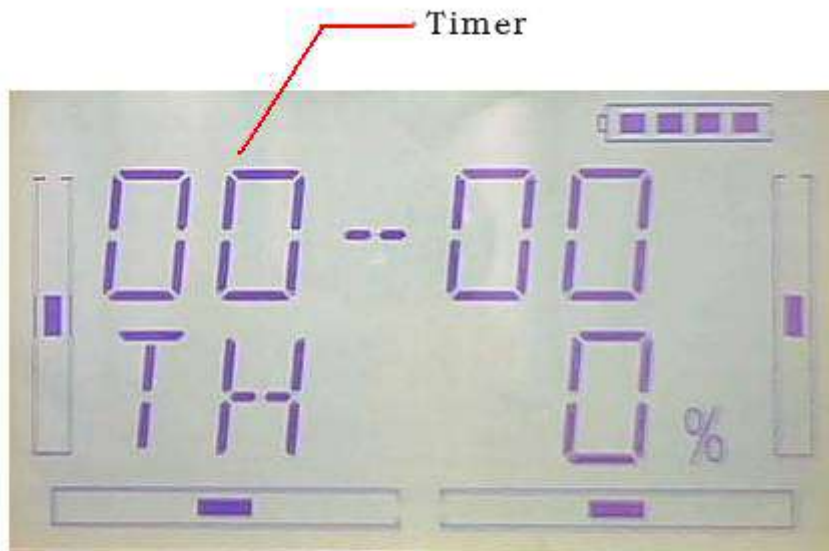

Press "ENT" to flash main menu. Press "UP" or "DN" to be showed flash "FUNCTION" then press "ENT" to enter function menu; Press UP or DN, make interface showed flash "TIMER" menu, press "ENT" to enter type selection. There are stopwatch and countdown. Press R or L to select.

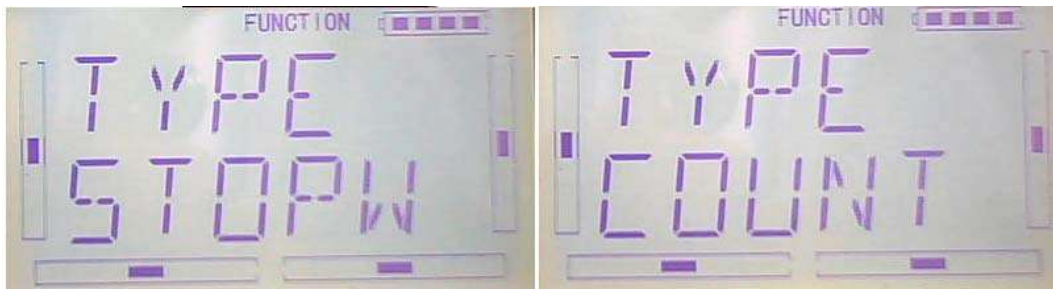

Stopwatch setting, the following interface for stopwatch, press EXT to exit



The max range of stopwatch is from 0 to 59 min 59 sec

A: Countdown setting: press R or L on press the above interface to select counterdown setting as following;



Press DN on above interface to enter countdown

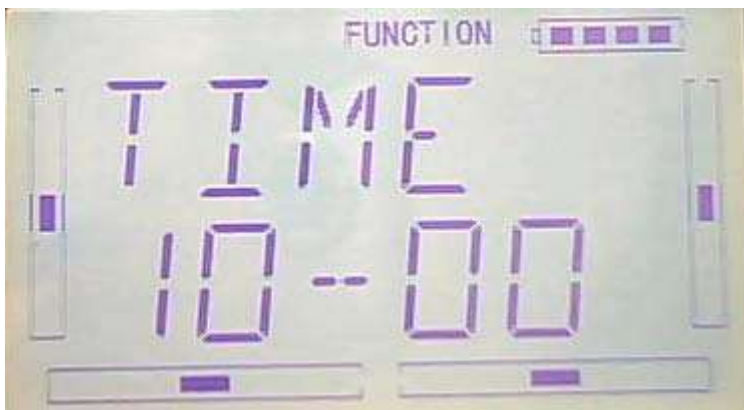

Press R or L to set countdown. The countdown rang of is from 00:05-59:55.

C:usage

Press UP on " on" interface AN to start on the first time, repress UP to stop; press DN, timer is the original 0

stopwatch interface

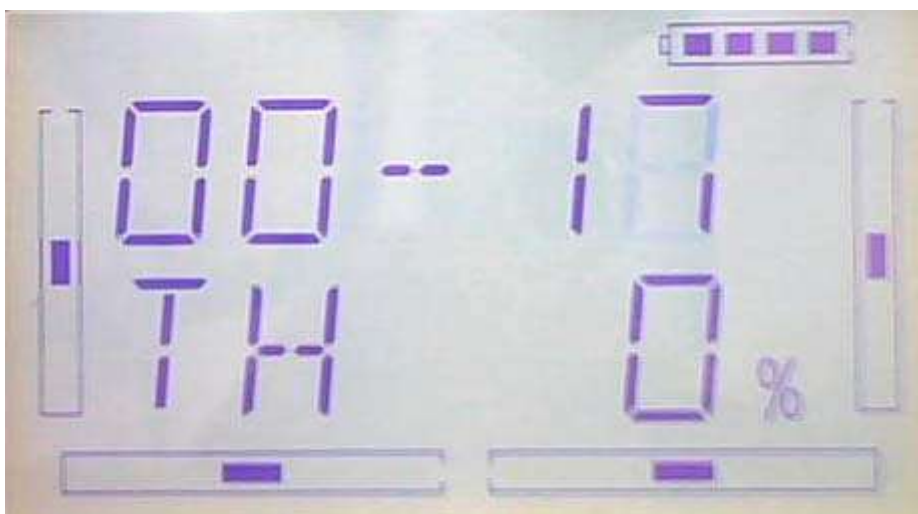

countdown interface



Part three: Airplane

1.0(system)

1.0 System menu

The related functions of Devo 7 are integrated to SYSTEM MENU, including DISPLAY, BUZZE, STICK MODE, STICK CALIBRATION and ABOUT.

The boot screen of airplane is shown as below:

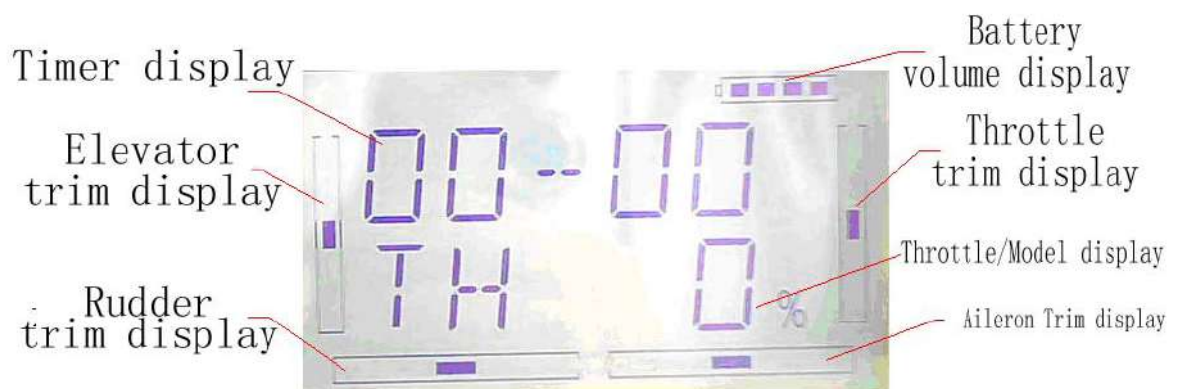

1.1 (DISPL)

1) Backlight brightness: the backlight brightness can be adjusted. The power

consumption will be increased if the backlight lightness is too bright and the battery cruise duration will be shortened.

2) Backlight time out: it is possible to set the duration which LCD stays at highlight in the form of Always on and duration from 5 to 60 seconds with an interval of 5 seconds.

SETUP: press ENT key in main interface, it appears twinkling main menu. Press UP or DN to get twinkling SYSTEM, and then press ENT to enter system menu, press UP or DN to get twinkling DISPL menu.

Press ENT key to enter brightness adjustment, you can adjust the brightness or turn off the backlight by press R or L.



Press DN in above interface to enter backlight time out setup, press R or L you can adjust the backlight duration, 60 seconds is longest time, 0 means always on.



Press EXT to exit after finished.

1.2 Buzzer warning

1) Buzzer switch: Press ENT key in main interface, it will shows twinkling main menu. Press UP or DN to get twinkling "SBUZZE", and press ENT to enter STATE menu. Press R or L to make twinkling figure turn into ON or OFF. On means active, OFF means inhibitive.

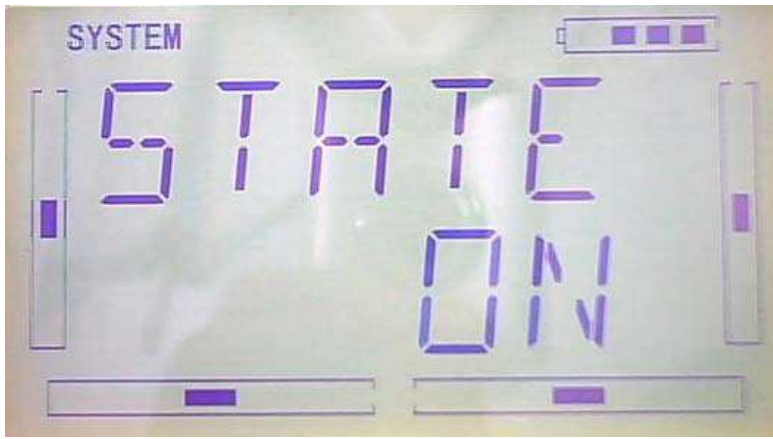

2) Throttle stick: under Buzzer Switch is at the status of On, if Throttle Stick is set as "Active", a relative musical scale will make response when moving the throttle stick. You can judge the position of the throttle stick according to the different musical scales. Also, it can be set as Inhibit.

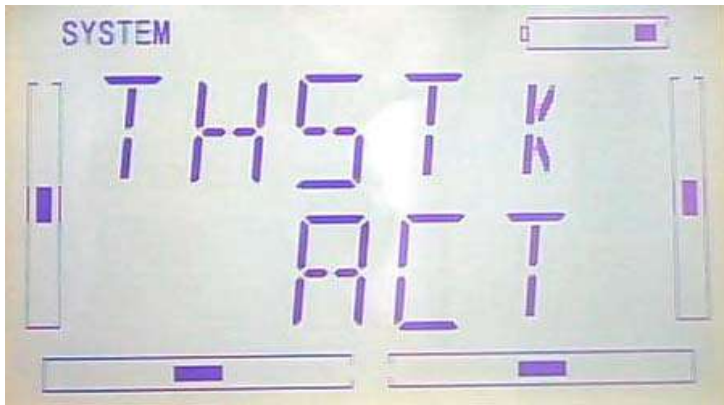

After finish above setup, press DN to enter THSTK setup interface. Then press R or L to set twinkling figure is INH or ACT. ACT is active, INH is inhibitive.

3) Buzzer tone: the tone is composed of 10 grades. You can choose the favorite tone according to your interests and make a listening test.

After above setup, Press DN to get TONE setup interface, then Press R or L to confirm the tone grade you want.

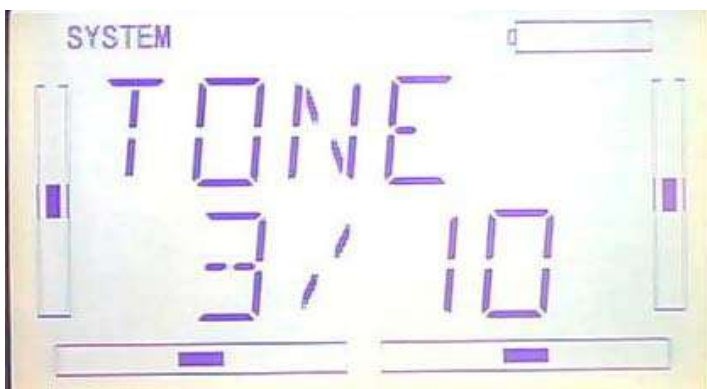

Press EXT to exit after finished.

1.3 Stick Mode

There are four stick modes from MODE 1 to MODE 4. Right-hand throttle includes MODE 1 and MODE 3, Left-hand throttle include MODE 2 and MODE 4.

Please see below picture.

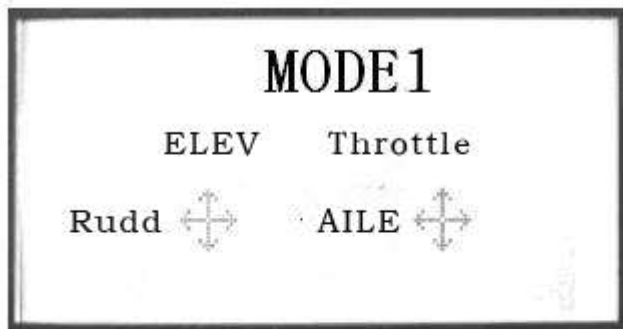

MODE 2 and MODE 4 are listed in left-hand throttle.

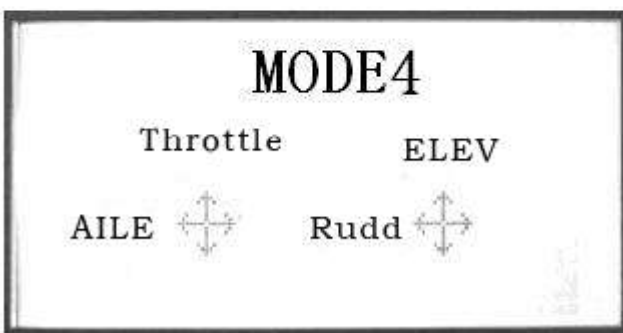
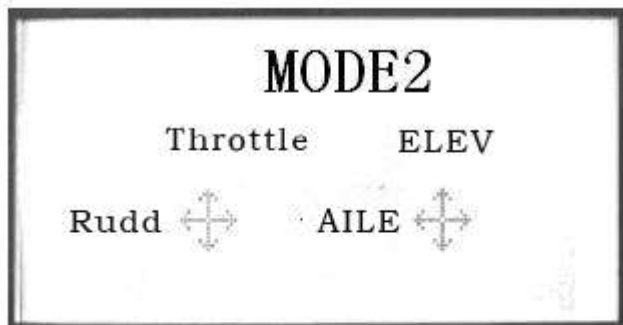

Stick Mode setup: Press ENT key in main interface and it will appears twinkling main

menu. Press UP or DN to get twinkling “STMOD”, and then press ENT to enter stick mode selection. Press R or L to choose stick model you desired, and then Press ENT to confirm.

Press EXT to exit after finished.

1.4 Calibration

Press “ENT” key in main interface then it will appears twinkling main menu. Press UP or DN to get twinkling “CALIB”, and then press ENT to enter calibration menu.you can start calibration after press ENT key.

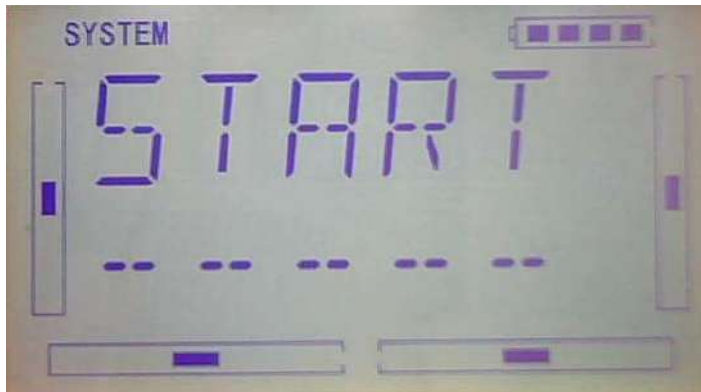

Press ENT to start stick calibration, it appears below interface.

Stick Calibration: Clockwise or counter clockwise mechanically move the right stick and left sticks from their minimum levels to their maximum levels several times, and then return the sticks to the neutral positions, respectively.



If shows below interface after press EXT, it means calibration is finished.



If shows below interface after press EXT, it means calibration failed and you should calibrate again



Press EXT to exit after finish.

1.5(About)

Press the key "ENT" in main Interface then it will show a twinkling Menu. Press "UP" or "DN" to get a twinklyng "SYSTEM", And then press "ENT" to enter system menu. Press "UP" or "DN" to get twinklyng "**ABOUT**". And then press "ENT" to get SOFT interface, you can check the versions of hardware and software.



Press EXT to exit after finish.

2.0(Model Menu)

Model Menu manages all the model data saved in DEVO-7. It includes Model Select, Model Name, Model Copy, Model Transmit, Model Receive, Model Reset, Type Select, Trim System, Stick Position, Warning, Device Select, Device Output, Wing Type and Fixed ID.

2.1 Model Selec

Press ENT to flash main menu in main interface, press UP or DN, MODEL will flash, and then press ENT to enter model menu; Press UP or DN to flash SELEC, Press ENT to enter into Mode Selec

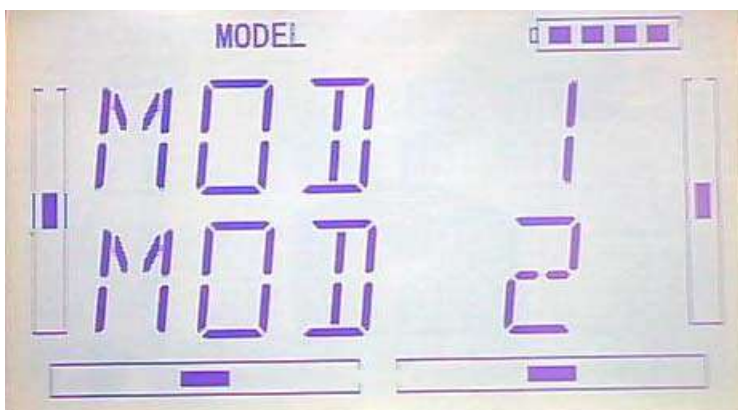

Press UP or DN to flash MODE, there are 15 setting memories for option.

Press ENT to confirm, and press EXT after finish.

2.2 Model Name

In the MODEL NAME menu, you can give a name to your heli as your expect and save it for next time's flightt.

Please repeat the step"2.1 model selec", choose mode number you want to rename and to save.

Press ENT to flash main menu in main interface, press UP or DN to flash MODEL, then press ENT to enter model menu; press UP or DN to flash NAME, press ENT to show model number and old name

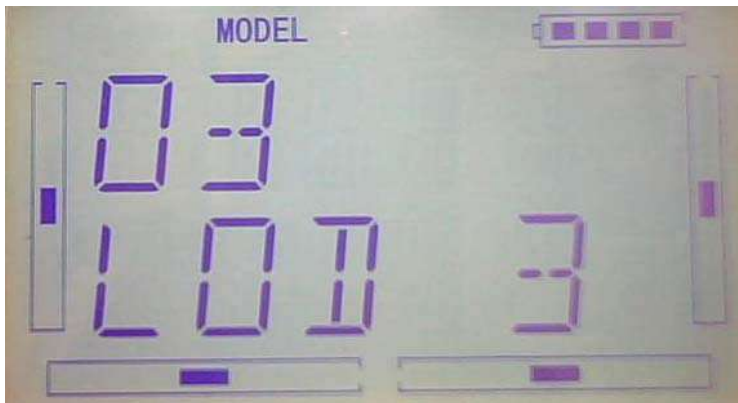

Press UP or DN to move the character and figure need to change, press R or L to change the character and figure. Press EXT after finish.

2.3 Model Copy

Press ENT to flash main menu in main interface, and press UP or DN to flash MODEL, then press ENT to enter model menu, press UP or DN to flash COPY; press ENT to show source model, and press R or L to choose model source again.



Press ENT to show model you want to change, and press ENT, the inquiring interface will be shown. Press R or L to choose ON or YES, and then press YES to copy, press NO to give up.



Press ENT to back to menu after copy and then press EXT

2.4 Model wireless copy

The model data between two DEVO7 can be copied and shared through model transfer and model receiving in model menu.

1) Model transfer

Press ENT to flash main menu in main interface, press UP or DN to flash MODEL, then press ENT to enter model menu, press UP or DN to flash TRANS, press ENT, model name ready for transfer will be shown. Press R or L to choose model



After choose the model to transfer, please press ENT to enter inquiring interface. Press R or L to choose ON or YES, press YES to copy and press NO to give up.



Press ENT, it is transferring, refer to image as below:



Press EXT after finish

2) (RECEI) model recei

Press ENT to flash main menu in main interface, and press UP or DN to flash MODEL, then press ENT to enter model menu; Press UP or DN to flash RECEI, and press ENT to enter the inquiring interface. Press R or L to choose ON or YES, and choose YES to receiver, choose NO to give up.



Choose YES to receive, and press ENT to show model connecting interface...

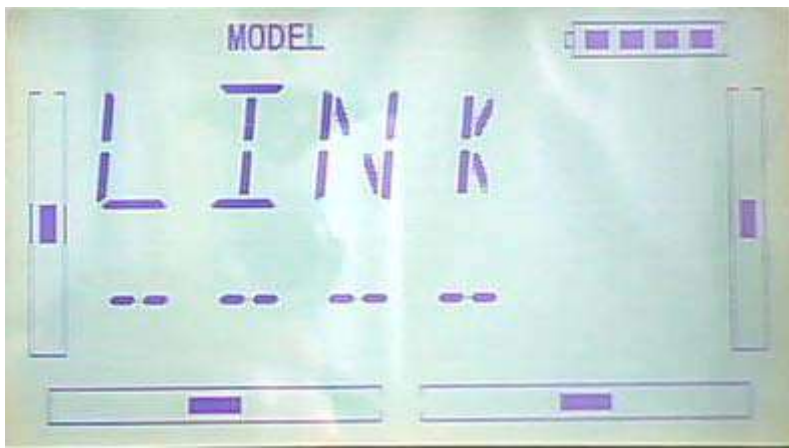

The model name will flash after model data transfer, and press R or L to change the save place for model data. Press ENT to enter inquiring interface. Press R or L to choose ON or YES. Choose YES to save and choose No to give up.



Press YES to save data and press ENT to back to menu.

Press EXT to after finish

2.5 Model RESET

Press MODE RESET to recover all data to factory setting

Press ENT to flash main menu in main interface. Press UP or DN to flash MODEL, and then press ENT to enter model menu. Press UP or DN to flash RESET, press ENT to enter item for option. There are WHOLE RESET or UNIQUE RESET for option. Press R or L to choose item need to reset.

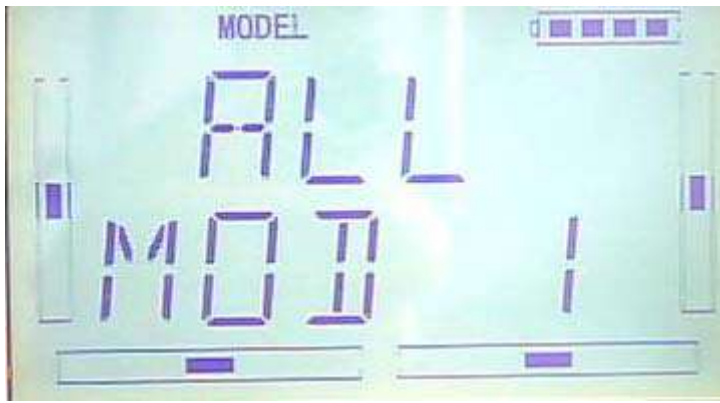

Press ENT to enter the inquiring interface. Press R or L to choose ON or YES, press YES to continue and press NO to give up.



Press ENT to confirm and back to menu. Press EXT after finish.

2.6TYPE OPTION

There are two type for option: helicopter and airplane.

Press ENT to flash main menu in main interface. And press UP or DN to flash MODEL, and press ENT to enter into model menu. Press UP or DN to flash TYPE, and press ENT. There are helicopter and airplane for option, press R or L to flash the item be chosen.

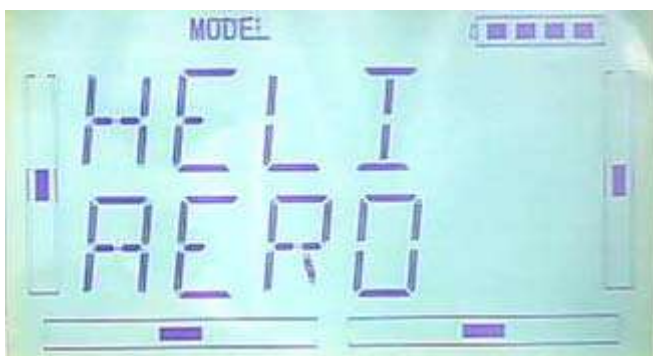

Press EXT after finish

2.7 Trim system

Trim System is able to finely tune the following six items, respectively: Elevator, Aileron, Rudder, Throttle, Left Trim, and Right Trim. The trim range is divided into 20 grades (factory default is set at 4). It is convenient to subtly modify the pitch by adjusting the trim range.,settings are belows:

Press ENT in the main interface,main menu blinking,,press UP or DN to sppear "MODEL"then press ENT to enter model menu, press UP or DN, "STEP" blinking,Press ENT to appear selectable options, there are elevator, aileron, and rudder, step range,Press R or L to change the step range,the maximun is 20



there are elevator, aileron, and rudder, Normal and Limited. "Normal" means the trim is always working although the corresponding stick stays anywhere. "Limited" means the trim is out of working when the corresponding stick is at maximum position.

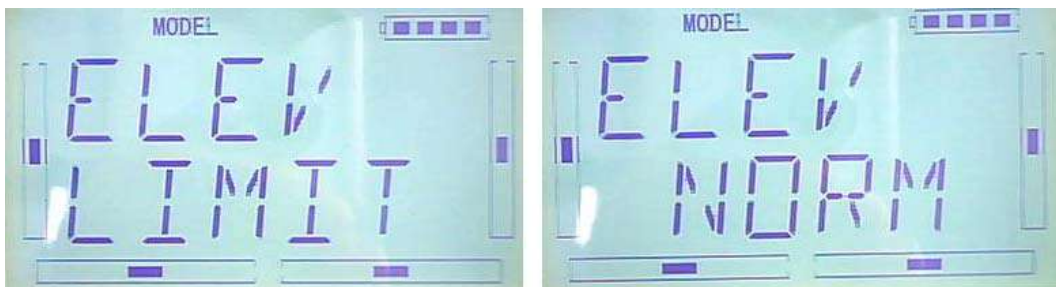

Press R or L to select Normal and Limited,once finished, press EXT to exit.

2.8 Device select

This setting can help you configure various functional switches, or adjust levers. It

includes Flight Mode Main Switch, Stunt Trim Select, Throttle Hold Switch, Hovering Pitch, and Hovering Throttle.

1) Press ENT in the main interface, main menu blinking, press UP or DN to appear blinking MODEM, then press ENT to enter the model menu, press UP or DN to appear blinking "INPUT", press ENT to appear selectable options, there are Flight Mode Main Switch option, Throttle Hold Switch option, Hovering Throttle options

2) Flight Mode Main Switch

Press R or L to select INH, FMD or MIX switch, The factory default setting is FMOD SW.

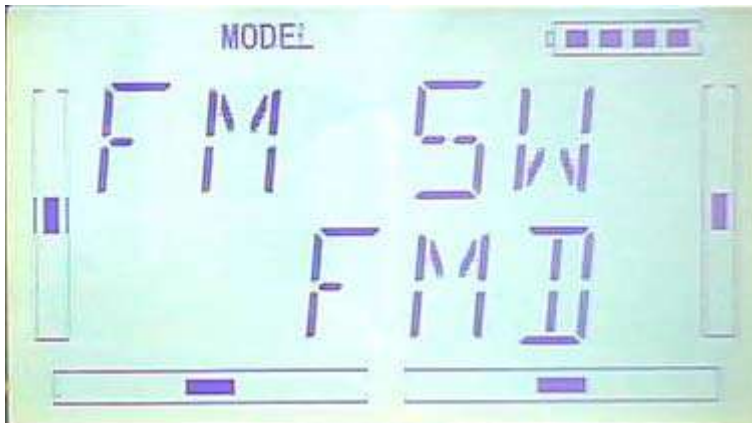

3) Stunt Trim Select

There are two modes: Common and Flight Mode. In Common mode all the trim values, which various sticks are corresponding to, put equally effects on all the flight modes.

In Flight Mode, the trim value, which each stick is corresponding to, puts independently effect on the corresponding stick. The factory default is Common.

Settings: once finished the step2 , press DN to appear below interface, press R or L to select COMM or FMOD

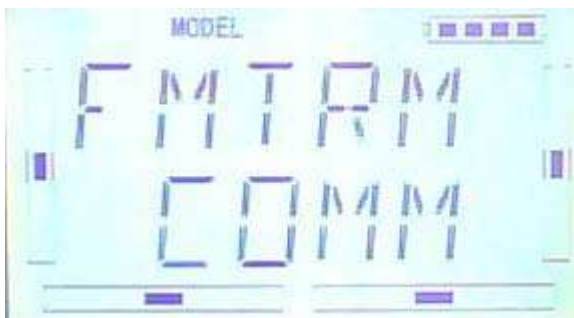

4)Throttle Hold Switch

There are GEAR switch,HOLD switch,D/R switch, MIX2、MIX12、FMD2、FMD12,
The factory default is HOLD switch

5) Settings: once finished the step2 , press DN to appear below interface,press R or L
to select switch

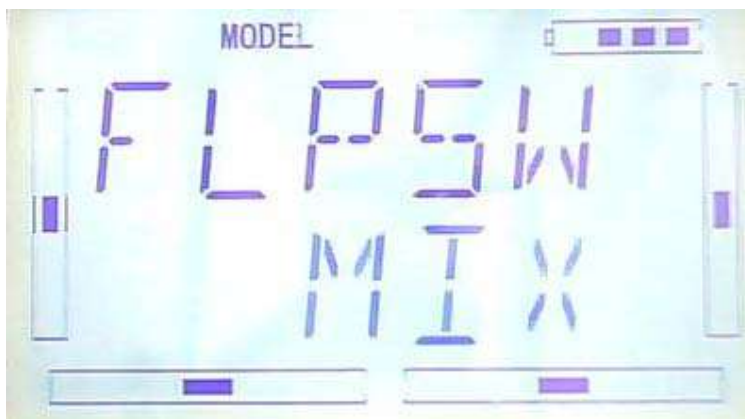
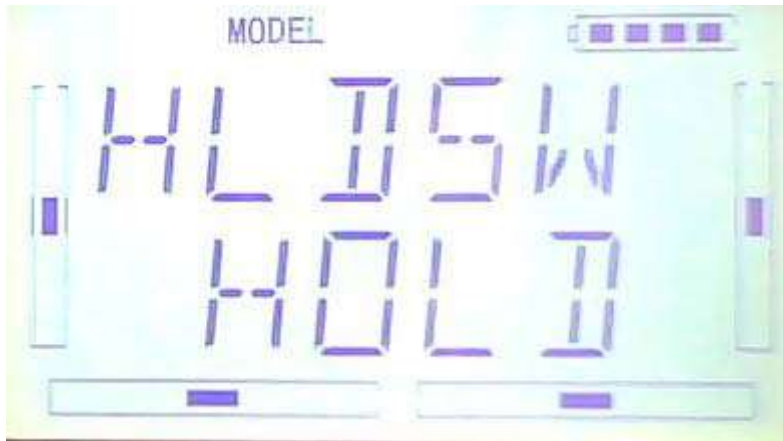

Setting method: once finished the step3 , press DN to appear below interface,press R
or L to select MIX or FMD switch,once finished the setting, press ENT to exit,

2.9 Device Output

Device output can set up the output switches and select the usage of levers,
respectively. It can also activate, inhibit or use other functions.

Setting method:

Press ENT in the main interface, main menu will be blinking, press UP or DN to

appear blinking "MODEL", then press "ENT" to enter model menu, press UP or DN to appear blinking "OUTPUT";press ENT to appear setting items and selectable switch,,

There are three adjustable items. They are Gear, AUX2 and AUX3, respectively.

1) Under the above interface,press R or L to change to select GEAR switch or button option,ther are FMOD SW, MIX SW, D/R, HOLD , GERA SWTRN and AUX and so on. The default setting is GEAR SW.

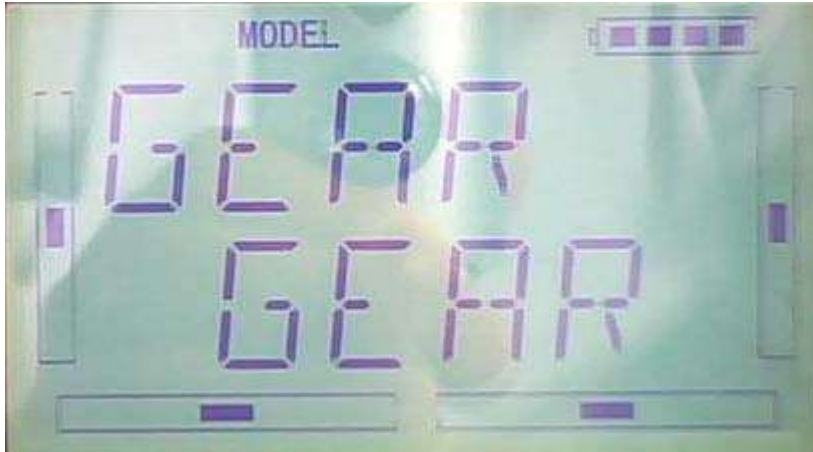

Press DN to enter GEAR ACT ,INHIBIT and other functions options,

Press R or L to change select ACT ,INHIBIT and other functions options,there are INH、ACT、GOV。



2) FLAP

After set the GEAR , press DN to enter the FLAP setting, see belows, press R or L to change select FLAP SW or BUTTON option,there are FMD MIX D/R、HOLD、GEAR、TRN、AUX2 and so on

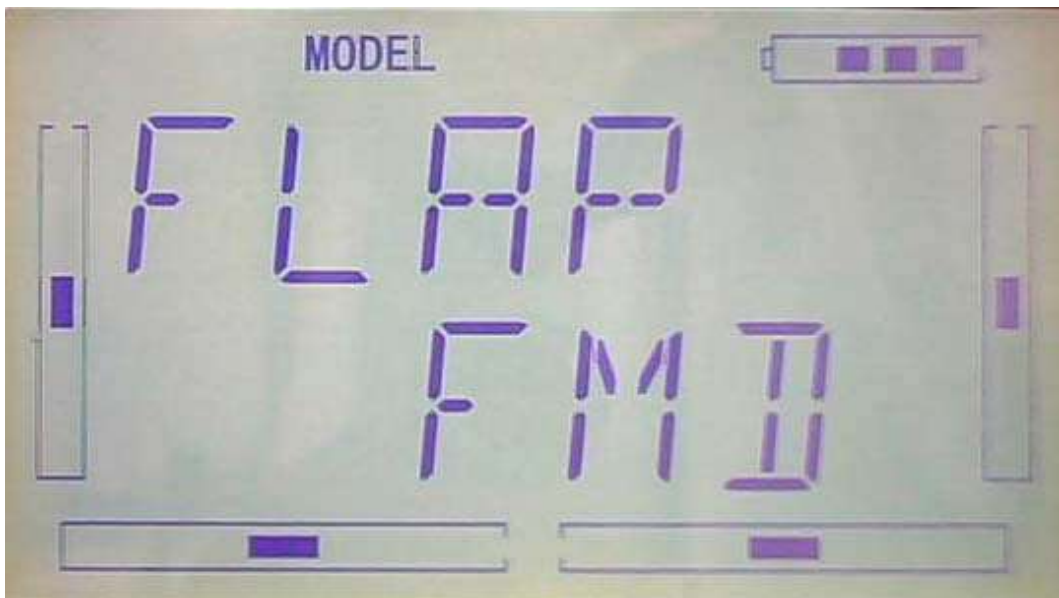

Press DN to enter FLAP ACT ,INHIBIT and other functions options,

Press R or L to change select enabled,forbiden and other functions options,there are NH、 ACT、 SYS。

3) (AUX2)

After set the FLAP , press DN to enter the AUX2 setting interface, press R or L to change select AUX2 SW or BUTTON option,there are FMD MIX D/R、 HOLD、 GEAR、 TRN、 AUX2 and so on .The default setting is FMOD.

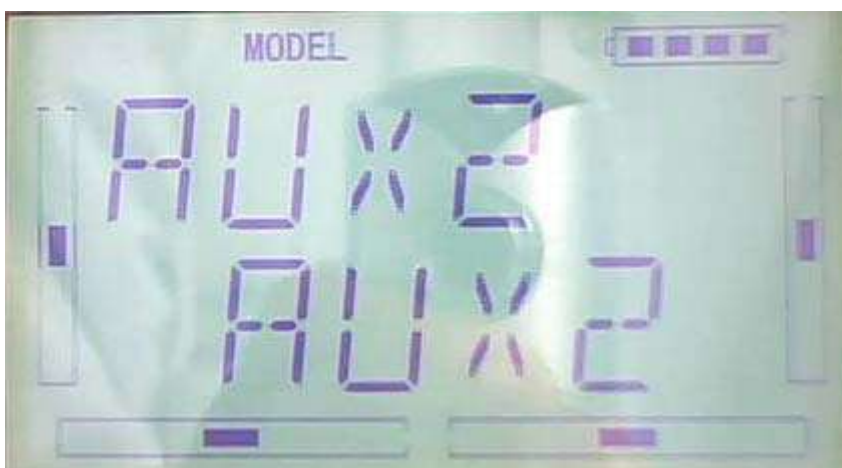

Press DN to enter AUX2 ACT,INHIBIT and other functions options,

Press R or L to change select enabled,forbiden and other functions options,there are INH、 ACT、 GYRO。



Once finished the settings, press EXT to exit.

2.10 (WING)

Wing Type is grouped into Flaperon, DLETA and V Tail.

Wing type selection:

Press ENT in the main interface to appear blinking main menu, press UP or DN to appear blinking "MODEL", press ENT to enter model menu, press UP or DN to appear blinking "WING", press ENT to enter wing type interface, see belows.



1) Press R or L to select types , there are NORMAL, Flaperon, DELTA, make the wing type blinking Choose the desired wing type.

Below is the graphics for the servos location of the Flap and Aileron Type.

1.1) Flaperon

Below is the graphics for the servos location of the Flap and Aileron

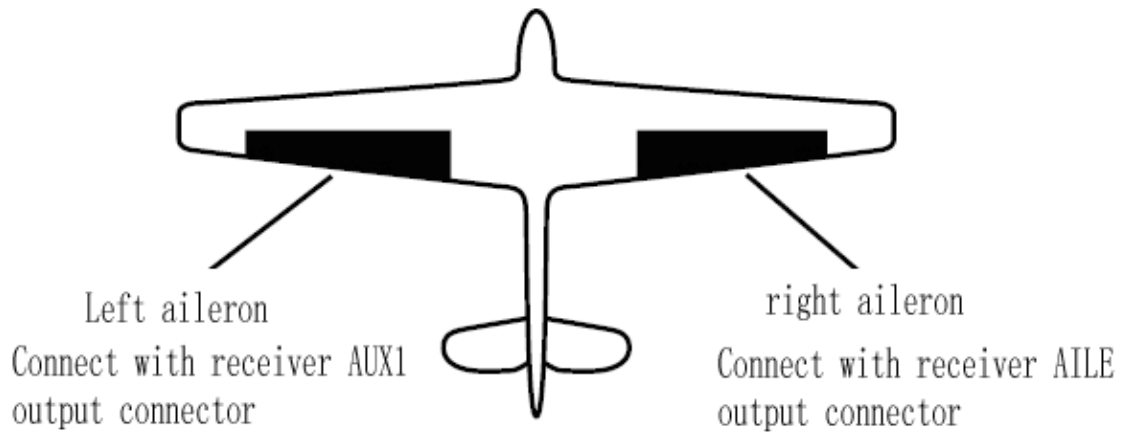

1.2) DELTA

Below is the graphics of the servos location of the Delta Type.

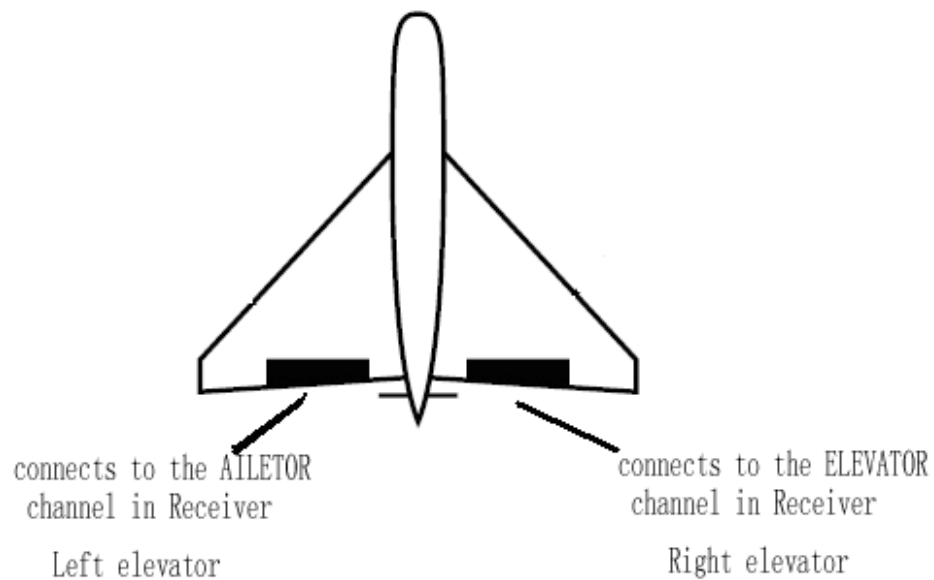

connects to the ELEVRON channel in Receiver

2) V-TAIL(once wing type selected the DELTA,V-Tail will not appeared.)

Press R or L ,under V-TAIL setting interface ,there are" INHIBIT" and "ACT",select 'ACT" as below,

Below is the graphics for the servos location of the V-tail



Below is the graphics for the servos location of the V-tail Type.

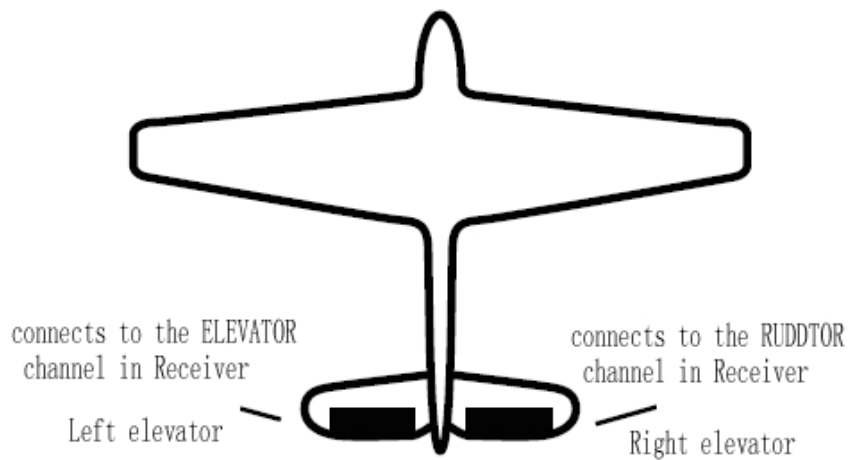

connects to the ELEVATOR channel in Receiver

Left elevator

connects to the RUDDER channel in Receiver

Right elevator

3)Dual channels setting

Dual Channels can be set as Elevator, Aileron, Rudder, or Flaperon. It is of dual

channel output function. The channel, which will be set as dual channel at AUX in Device Output (Refer to “2.9 Device Output”), should be previously set as Inhibit when the AUX channel is being set.

3.1 Setting method:

Setting method:

Once finished setting V-TAIL , press DN to enter the dual channel setting interface, see belows



Press R or L to select usable channel, the channel can be changable under below circumstance.

A: Select “Normal” option in the wing type selection, V-TAIL is inhibit options, the channel setting options including Elevator, Aileron, Rudder, and Flap. Select “Nor” options in the wing type selection, V-TAIL is ACT options, the channel setting options including Aileron, and Flap

B : Select “FLAP” option in the wing type selection, V-TAIL is inhibit option , the channel setting options including Elevator, Rudder . Select “FLAP” option in the wing type selection, V-TAIL is ACT option , the channel setting option will not appear

C: Select “DLETA” option in the wing type selection, V-TAIL is inhibit option , the channel setting options including Rudder, and Flap. Select “Nor” options in the wing type selection, V-TAIL can not be ACT

3.2) sub dual channel settings

Once finished “channel setting”, press DN to enter sub channel setting interface, see below

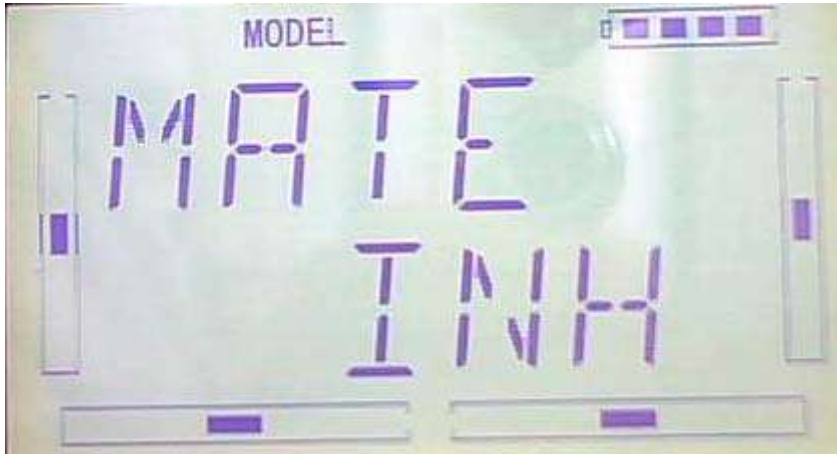

Press R or L ,there are INHIBIT and the channel that has been inhibited in the 2.9 device output menu,select the desired setting channel and make blinking ,if desired channel has been occupied,the setting will not appear.

4)Twin Engine

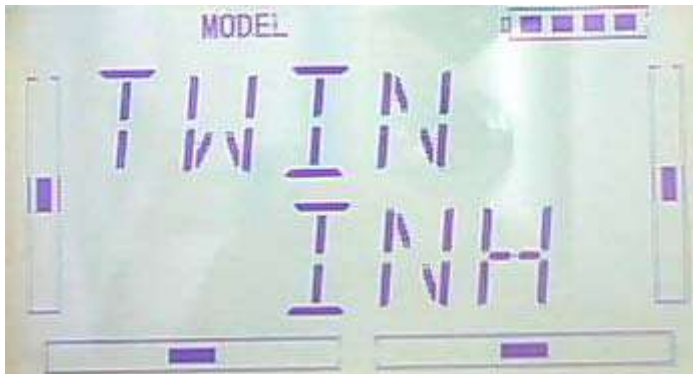

This function can be set as twin engine output to meet the requirement for the models, which are powered by twin engines.

twin engine sub channel setting:once finished setting dual channel , press DN to enter the twin engine setting interface, see belows:

Press R or L ,,there are Inhibit and the channel that has been forbidden in the 2.9 device output menu,select the desired setting channel and make blinking ,if channel has been occupied,the setting will not appear.

1.7 Power amplifier



The transmission output power of DEVO-7 is adjustable. It is divided into six grades from small to big. The lower the transmission output power transmits, the shorter the radio range is, and the longer the stand-by time will be. The higher the transmission output power, the farther the radio range, and the shorter the stand-by time. Choose the appropriate transmission output power according to the actual situation.

Setting method:

Press "ENT" in the main interface to appear blinking menu, press UP or DN to appear blinking "AMPLI", then press "ENT" to enter power select interface, press UP or DN, selected power number will be blinking, press ENT to confirm. once finished the setting, press EXT to exit.

2.12 (FIXID)

This setting will bind DEVO-7 and its receiver in a unique corresponding relationship. It will greatly speed up the time of automatic binding when DEVO-7 powered on.

1) Setting for fixed ID

The setting for fixed ID should be under the status that automatic ID binding is successfully finished. Below is the setting method.

1) Setting for fixed ID

Press "ENT" in the main interface, the main menu will be blinking, press UP or DN to appear blink "MODEL" then press "ENT" to enter model menu. Press UP or DN, "FIXID" will be blinking,

Press "ENT" to enter switch status selection, press R or L to select "ON", press DN to enter the fixed ID code setting.

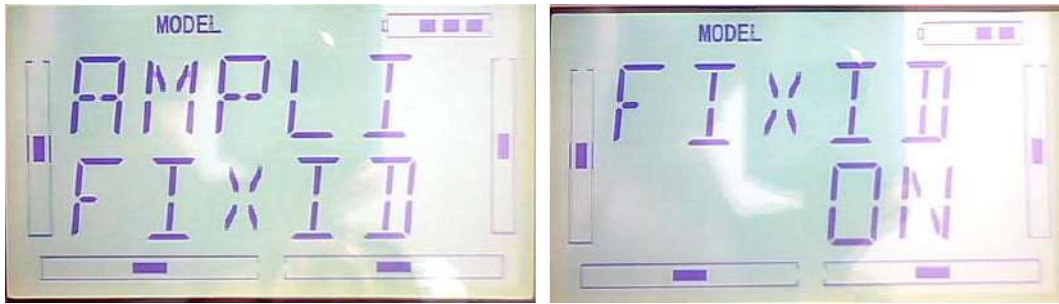

Press ENT to change the letter blinking , press R or L to change the number, press DN to move to adjust the next number, once finished ,press ENT to appear “RUN interface”, press R or L to change ON to YES, press ENT to pair the ID code,it will be back to the model menu automatically, once finished.

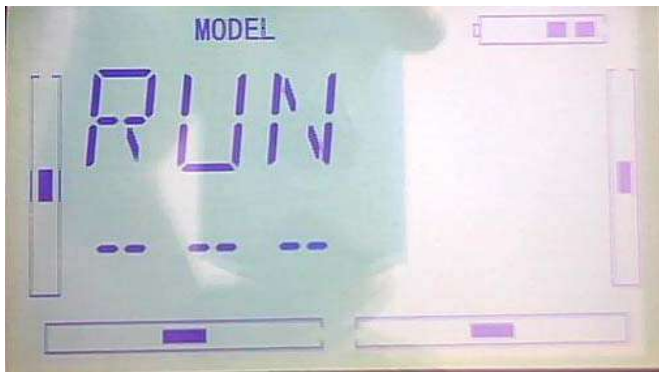
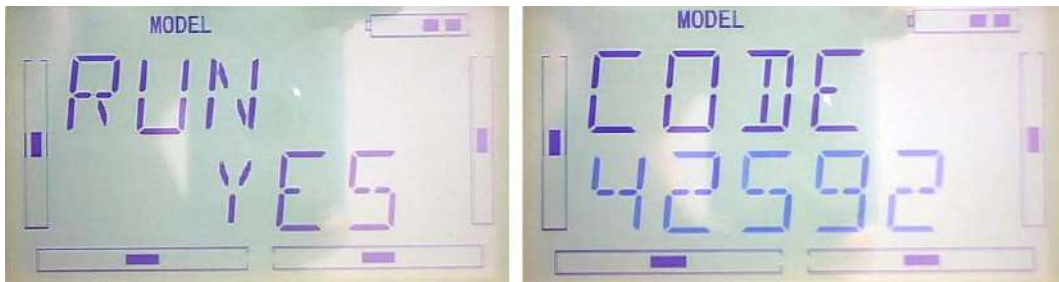

2) Fixed ID cancellation

Insert the assorted BIND PLUG into the output terminal of BATT before the receiver is powered on, and then plug 5V DC power into other output terminal. The red light of receiver will flash slowly. This means the fixed ID code has been cancelled. Pull out BIND PLUG.



After cancelled the fixed ID code in the receiver, transmitter has to reset relatively.

Refer to the above fixed ID setting step,once to the below interface, press UP



Once appear below interface, press R or L to change on to off, press EXT to exit.

3.0 Function Menu

Function Menu can help you make **CUSTOM** adjustments for the selected models. The menu includes such items as Reverse Switch, Travel Adjust, Sub Trim, Dual Rate and Exponential, Throttle Hold, Throttle Curve, Roll Stunt, Difference Setting, Balance Setting, Gyro Sensor, Governor, Aileron-Rudder Mix, Elevator-Flap Mix, Rudder-Aileron / Elevator Mix, Flap System, Aileron-Flap Mix, Program Mix, Monitor, Fail Safe, Trainer, and Timer.

3.1 Reverse Setting

Press ENT to enter the flashing main menu, Press UP or DN to flash "FUNCTION", and then press "ENT" to enter Function Menu; Press UP or DN to flash "REVSW"; Press ENT, The options for Channel Name and flashing Reverse Switch will be shown. Press R or L to change NOR or REV state. Press DN, there are Reverse Switches in

turn for AILE, THRO, RUDD, GEAR, PITCH, GYRO and so on. The setting are the same as above, Press EXT to finish it.

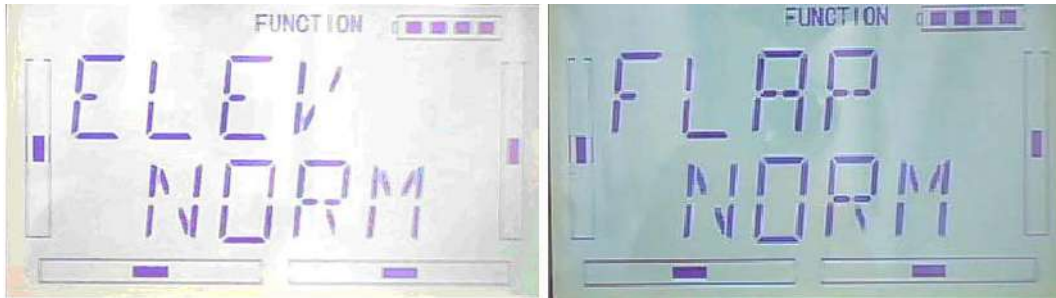

3.2 Travel Adjust

Press ENT to enter Main Menu, press UP or DN until “FUNCTION” flash, and then press ENT to enter Function Menu; Press UP or DN button to flash “TRVAD”; Press ENT button to enter the options for Channel names and flashing travel range. Press R or L to change the setting value of travel range; Press DN button, there are travel range setting options in turn for AILE, THRO, RUDD, GEAR, FLAP, GYRO and so on. The setting are the same as above, here we take the ELEV picture for example as below. EXT it for finish.

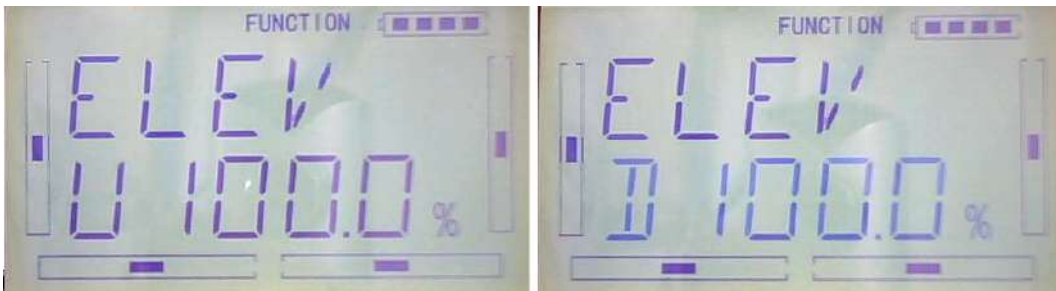

3.3 (Sub Trim)

Sub Trim is used to make parallel movement of the neutral point of the servo. But we advise you to mechanically adjust the servo bell crank if offset is far away from the neutral point of servo. Because servo would be damaged if excessive usage of the sub trim and beyond its range.

Setting: Press ENT to enter Main Menu, press UP or DN until “FUNCTION” flash, and then press ENT to enter Function Menu; Press UP or DN to flash “SUBTR”; Press ENT to enter the options for Channel names and flashing neutral point value. It is possible to change the neutral point setting value through R or L button,if the direction

is reverse, change the sign “+”“-” before value. Press DN button, there are neutral point value setting options in turn for AILE, THRO, RUDD, GEAR, FLAP, GYRO and so on. The setting are the same as above, here we take the ELEV for example. Its picture as below:



Every Channel default setting value is 0.0%. The adjustment ranges are as below:

Channel Name	Adjustment range	Channel Name	Adjustment range
Elevator	D62.5%-U62.5%	Gear	-62.5%- +62.5%
Aileron	R62.5%-L62.5%	Flap	D62.5%-U62.5%
Throttle	L62.5%-H62.5%	Gyro	-62.5%- +62.5%
Rudder	R62.5%-L62.5%		

EXT it for finish.

3.4 Dual rate and Exponential

After this function is set up, it is possible for D/R switches to control the dual rates of elevator, aileron, and rudder, respectively. The setting range is covered from 0% to 125%. Under the help with exponential curve adjustment, it is possible to make both customized settings and automatic settings.

The switch between Dual Rate and Exponential can be performed via pushing or pulling the Flight Mode lever.

1) Channel selection

How to set: Press ENT to flash main menu in main interface, press UP or DN to flash FUNCTION, and press ENT to enter into function menu; Press UP or DN to flash DREXP, press ENT to show Channel name. Press R or L to choose ELEV,AILE,RUDD. Take ELEV for example, as below image:



2) Position selection

Press DN in above image to show SWITCH POS. There are POS0, POS1 and POS2. Press R or L, the switch will be taken place among POS0, POS1 and POS2



D/R switch position on Radio



3) Dual Rate adjustment

After your POSITION setting, press DN to show D/R interface, press R or L to set D/R value.

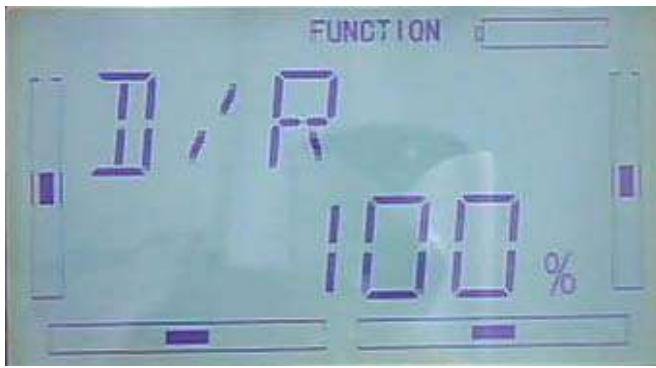

4) Exponential adjustment

After DUAL RATE adjustment finished, press DN to enter EXP interface. There are two way of setting: line and adjustable value

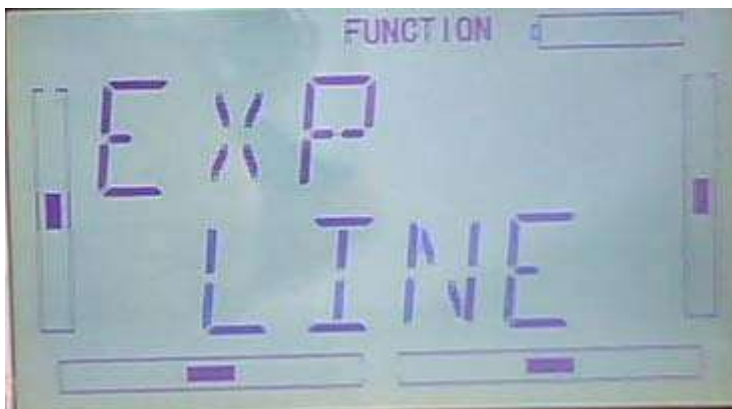

5) Automatic setting

The switch between Dual Rate and Exponential can be performed via pushing or pulling the Flight Mode lever. The setting for Flight mode0, Flight mode 1 and Flight mode2 are available. This function will become available only when FLIGHT MODE SWITCH under DEVICE SELECTION in MODEL MENU is activated(refer to 2.8 device selec)

Under Flight Mode, it is possible to switch the dual rate and exponential, which are set in above "3) Dual Rate adjustment" and "4) Exponential adjustment", respectively.



6)After exponential curve setting is ok, press DN to enter into RM0 interface, and press R or L to flash SWITC, POS0,POS1 and POS2. Press R or L to choose the item to be set.



After NORM mode setting finished, press DN to enter into FM1 interface, in the same way in above

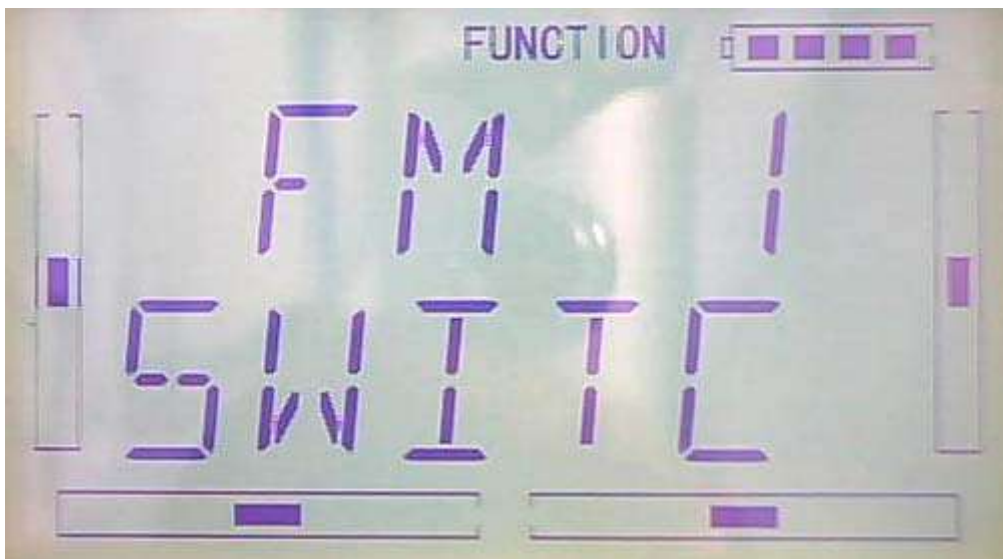

After FM1 setting finish, press DN to enter into FM2 interface, in the same way of setting:

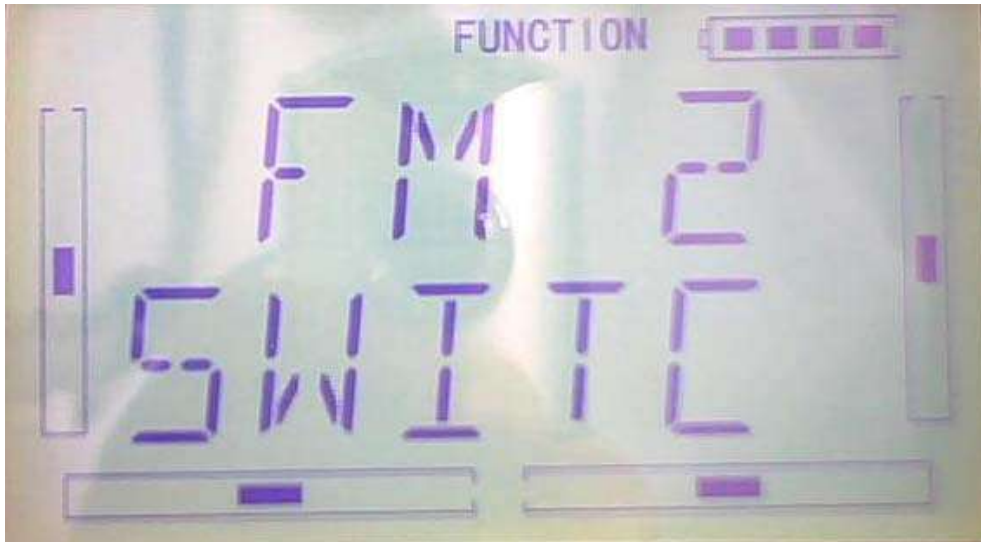

Press EXT after finish.

3.5 Throttle hold

If this function is set, the switch will be executed by hold switch. The setting value of throttle hold is ranged from -20.0 to 50.0.

Setting method:

Press ENT to flash main menu in main interface, press UP or DN to flash FUNCTION and press ENT to enter into Function menu. Press UP or DN to flash THHLD, then press ENT enter into throttle hold status. Press R or L to choose ACT(activate) or INH(inhabit), the factory default setting is INH



If throttle hold is activated, there will be THROTTLE HOLD POSITION menu shown

2) Throttle hold position setting

To activate throttle hold, please press DN to enter below interface



Press R or L to increase or decrease throttle hold value. Whole range if cover from -20.0% to +50.0%



Pull the HOLD SWITCH forward to turn on the throttle hold and pull the HOLD SWITCH backward to turn off the throttle

Press EXT after finish

3.6 Throttle curve

Press ENT to flash main in main interface., Press UP or DN to flash FUNCTION, and press ENT to enter into Function menu, presss UP or DN to flash THCRV., press ENT enter into inquiring interface on wether to hold seove or not. Press R to choose YES and press L to choose NO. Press ENT to confirm.

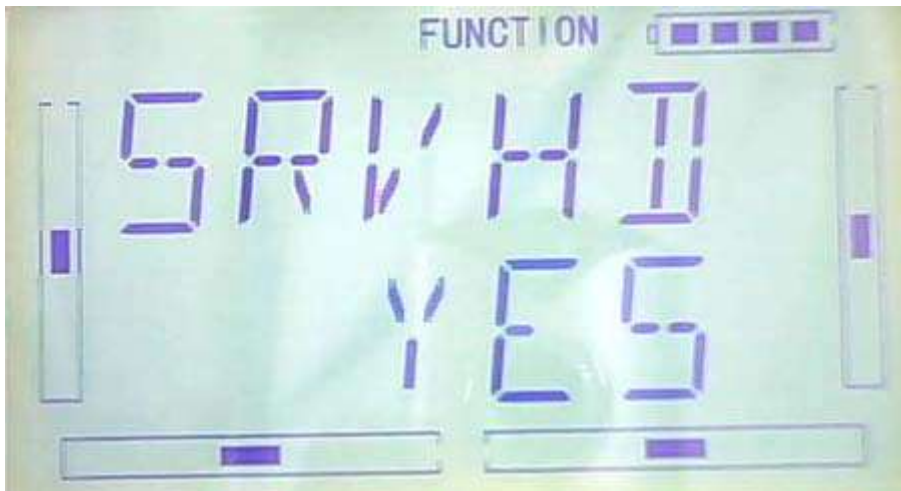

1) Position Setting

Please enter into below interface: press R or L to choose among POS0, POS1 and POS2



2). Exponential curve setting: after positioning setting is finished, press DN to enter into inquiring interface, EXP ON or OFF, press R to chose ON, L to choose OFF

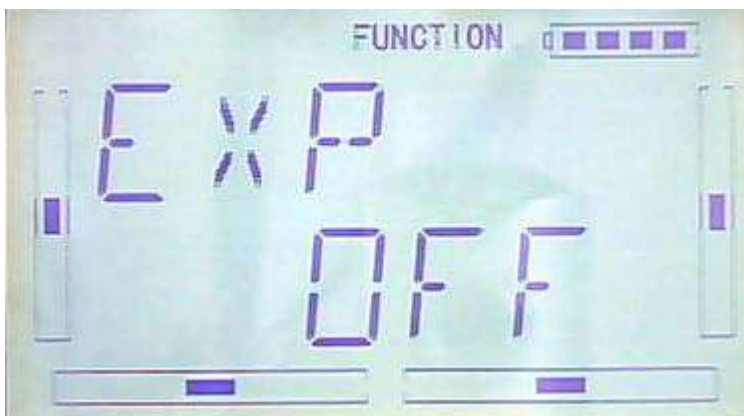

3) Point setting: after EXP item setting finished, presss DN, 7POINTS will be shown and press R or L to choose the point which you want to set. There are 7 points:

L,1,2,M,3,4 and H7. Press DN to enter POINT OUTPUT setting, press R or L to set the value you want.



Press UP to back to continue to set other points value.

4) Throttle lever setting: after point setting is finished, press DN to enter into Throttle lever interface. There are two settings, inhibit and Throttle lever position. Press R to choose INB and choose L to decrease value. The value is covered from 0.0% to 100.0%. The default setting of throttle lever is Inhibit

It's possible to switch throttle lever between POS1 and POS0 after setting finished. The data you set is both throttle lever position and turning point.

5)switch selection:

It's possible to switch between POS0 and POS1 when throttle lever item is inhibited.

Setting: After throttle lever is finished, please press DN to enter into position setting interface as below, which shows the switch status.



Press ENT to enter into LOGIC interface, there are inhibit and activate option, press R to choose inhibit and L to choose activate. It's ok to choose activate when two or more switches are in working,



Press DN to enter into Switch selection interface, there are FM0, FM1, FM2, FPNRM, FPMID, FPLND, D/R, HOLD and GEAR.



Press UP and DN to choose switch; Press R to choose activate and L to inhibit.

Press EXT after finish

3.7 Differential

If want to use this function, Flaperon, DELTA, should be previously selected in Wing Type of Model Menu. Refer to “2.10 Wing Type”.

Setting Method:

Press “ENT” in the main interface to appear blinking main menu, press UP or DN to appear blinking “FUNCTION”, press “ENT” to enter function menu, press UP or DN to appear blinking “DIFFE”, press ENT to appear channel display interface, see below.

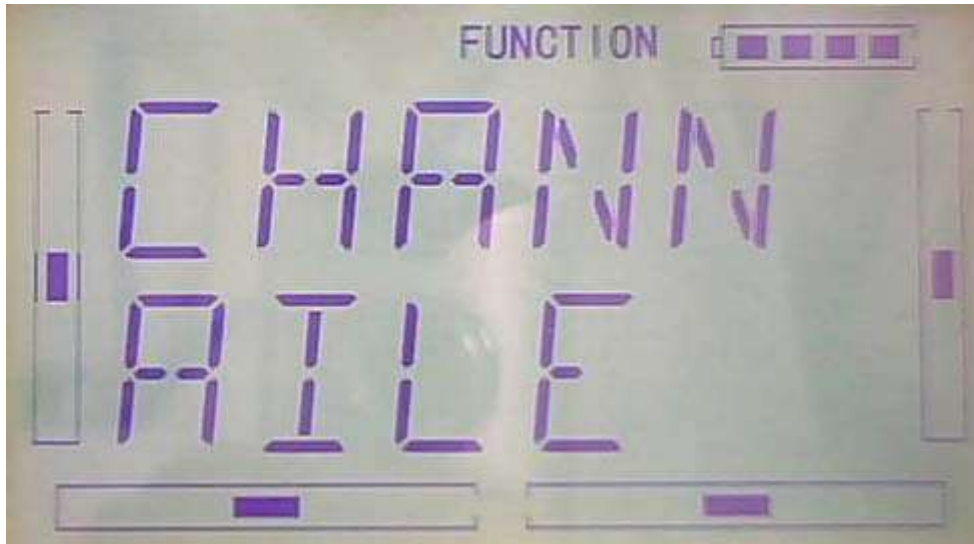

A. Aileron differential setting

Mounting servos in left and right ailerons are a must if using this function. The following interface will be shown after Flaperon, DELTA, selected in Wing Type. Refer to “2.10 Wing Type”. Press DN in the above interface to enter position setting interface,



1) Setting for Pos 0

Press R or L of Pos 0 to decrease or increase, The adjustable range is $\pm 100\%$.

2) Setting for Pos 1

The setting is same as above.

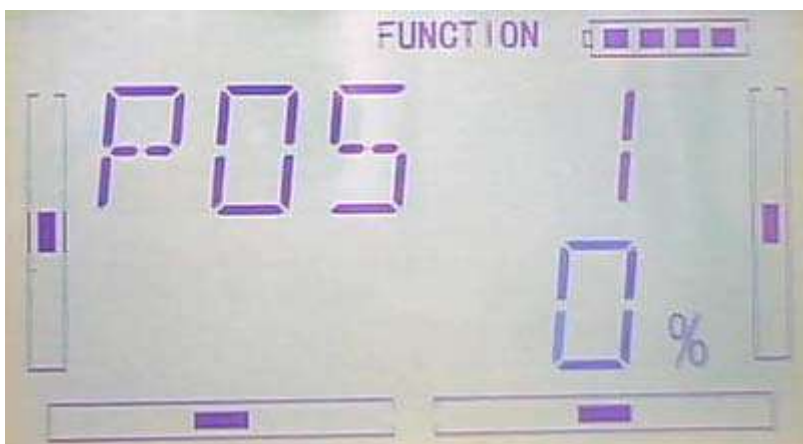

3) Switch selection

It is possible to switch by setting switch when differential is in use.

After setting Pos1 , press DN to enter "switch" item setting interface to display switch item and current switch status.

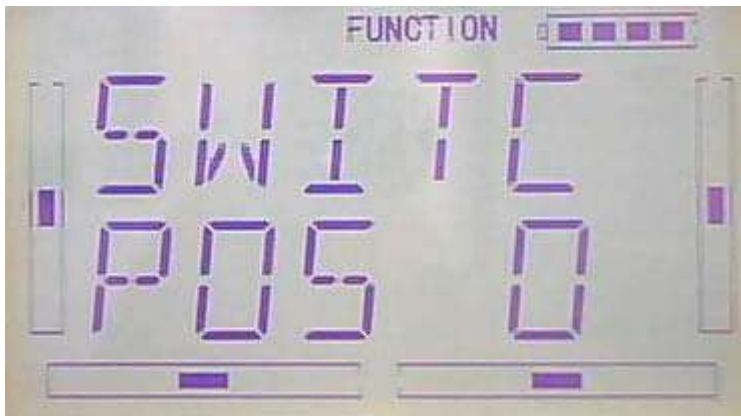

Press ENT to enter logic and interface, there are ACT and INHIBIT, press R or L to select inhibit and activate, if you select two switches or above, ACT can be selected.



After setting the above steps, Press DN to appear switch options, there are FM 0, FM 1, FM 2, FPNRM, FPMID, FPLND, D/R, HOLD, GEAR.



Press UP or DN to select using switch, press R or L to select switch Act or Inhibit.

After settings, press EXT to exit

B. Rudder differential setting

V-Tail should be previously set in Wing Type of Model Menu if the rudder differential function is activated. Refer to “2.10 Wing Type”. And then the following interface will be shown:

Setting Method:

Press “ENT” in the main interface to appear blinking main menu, press UP or DN to appear blinking “FUNCTION”, press “ENT” to enter function menu, press UP or DN to appear blinking “DIFFE”, press ENT to appear channel display interface, see below.

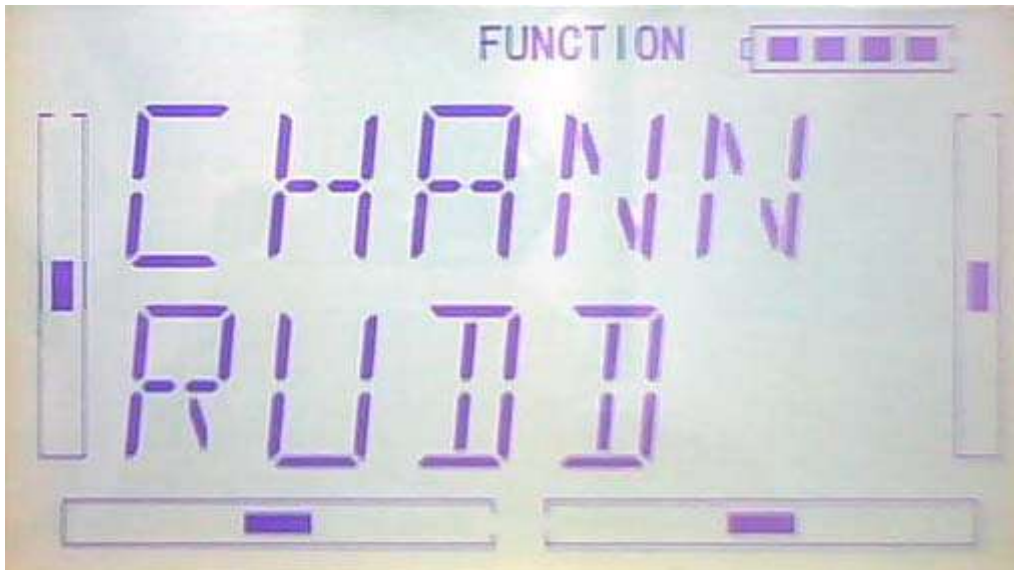

1)Setting for Pos 0

Press R or L of Pos 0 to decrease or increase,The adjustable range is $\pm 100\%$.



2)Setting for Pos 1

The setting is same as above.

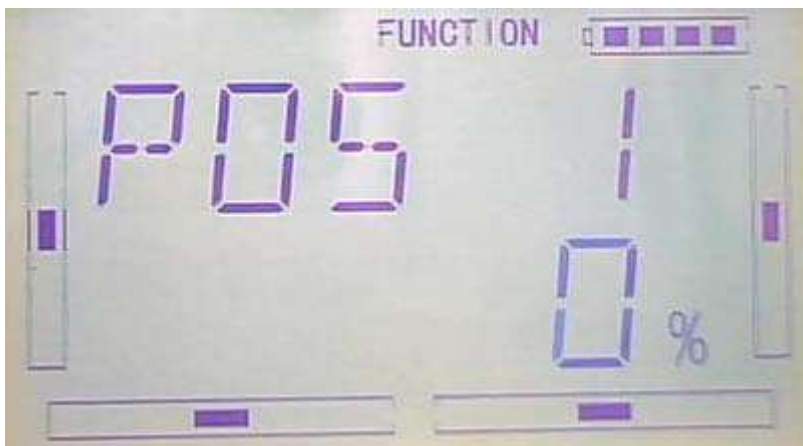

3) Switch selection

It is possible to switch by setting switch when differential is in use.

After setting Pos1 , press DN to enter “switch”item setting interface to display switch item and current switch status.

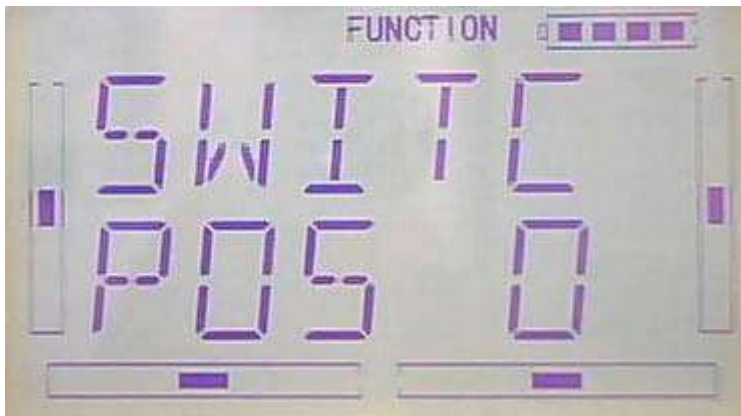

Press ENT to enter “AND” interface, there are ACT and INHIBIT, press R or L to select inhibit and activate ,if you select two switches or above ,ACT can be selected.



After setting the above steps,Press DN to appear switch options, there are FM 0、FM 1、FM 2、FPNRM、FPMID、FPLND、D/R、HOLD、GEAR。



Press UP or DN to select using switch, press R or L to select switch Act or Inhibit.

After settings, press EXT to exit

C. Flap differential setting

It should be previously set the flap dual channel function in Device Output at Model Menu (refer to “2.10 Wing Type”) in order to activate the menu of Flap Differential.



1) Setting for Pos 0

Touch the left or right navigation mark of Pos 0 to decrease or increase, respectively, differential value. The bigger the value is, the bigger the differential is. The adjustable range is $\pm 100\%$.



2) Setting for Pos 1

The setting is same as above.

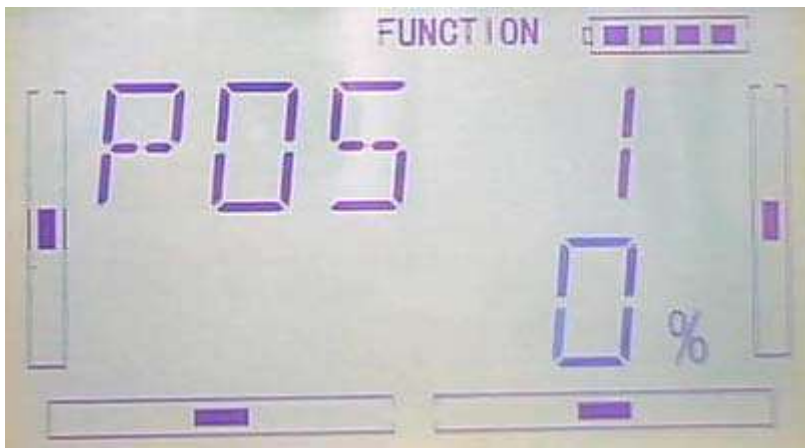

3) Switch selection

It is possible to switch by setting switch when differential is in use.

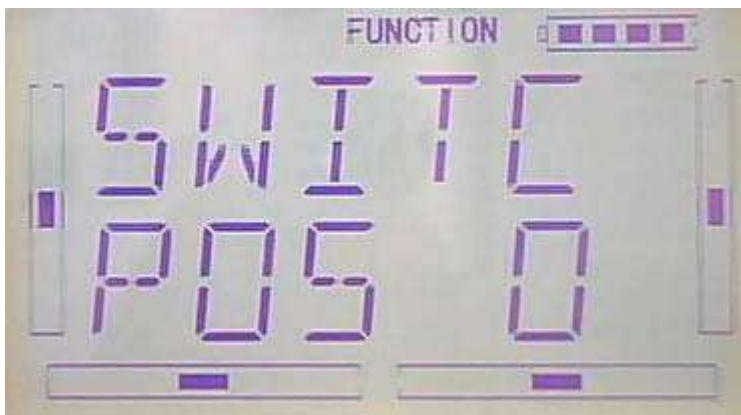

After setting the above steps, Press DN to appear switch options, there are FM 0、
FM 1、 FM 2、 FPNRM、 FPMID、 FPLND、 D/R、 HOLD、 GEAR。



Press UP or DN to select using switch, press R or L to select switch Act or Inhibit.

After settings, press EXT to exit

3.8 Balance

This function can adjust the parameters of the two servos which are used in the dual channels. It should be previously chosen one of the these wing types of Flaperon, DELTA and V Tail in Wing Type at Model Menu. Refer to "2.10 Wing Type".

Setting method:

Press ENT key in main interface to get twinkling main menu, then press UP or DN until flash FUNCTION appears, press ENT to enter function menu. And then Press UP or DN, it will come out bright BALAN, press ENT to enter Channel Rudd surface, refer to below picture.

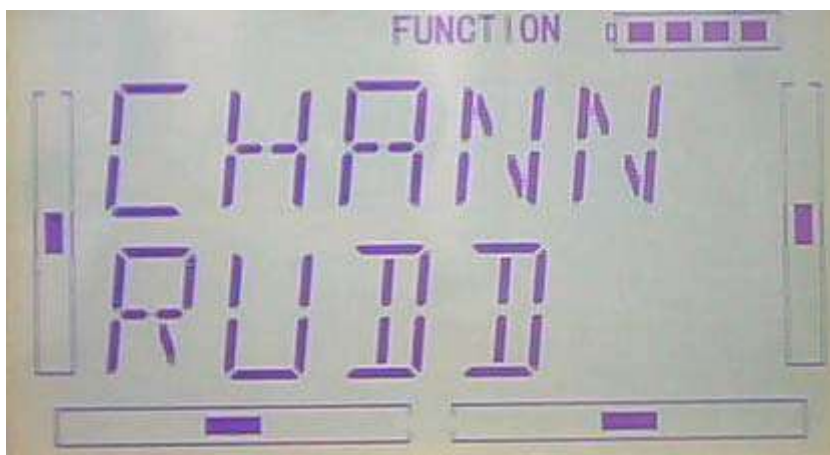

1) Channel Selection

1) Press R or L in above interface to make the channel you want flash, press DN to enter Point parameter adjustment

Point parameter adjustment

Please see below picture, POS < R setting. Point parameter is adjustable in range $\pm 100\%$ by press R or L key.

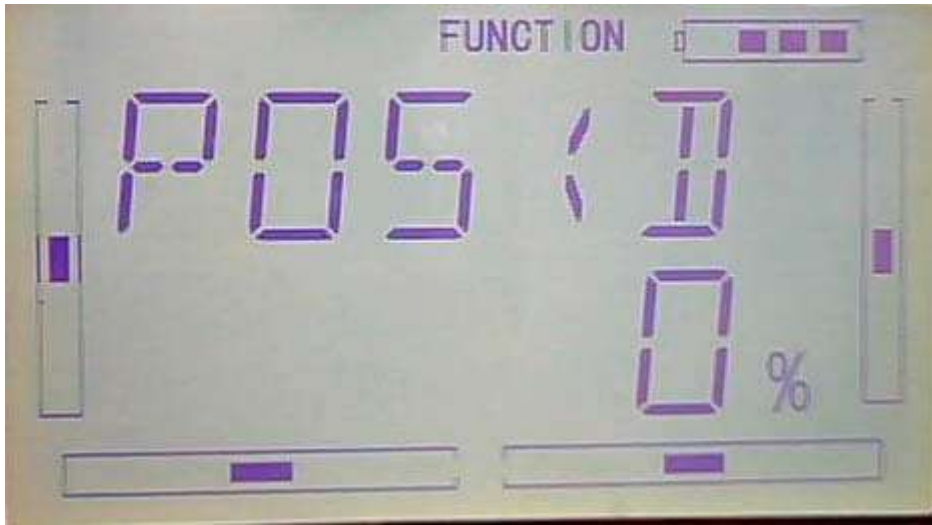

Press DN to enter the next setting POS – R, there are two choice by press R or L: Inhibit and Active. Press Active if you want adjust, then press DN to enter value adjustment interface.

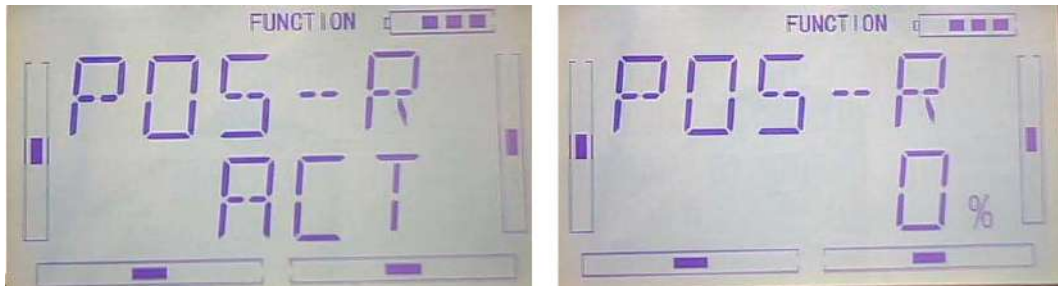

Press R key (0% means no adjusting), a minus value shows, it means the amending direction is downward, Press L key, a plus value shows, it means the amending direction is upward. The range is $\pm 100\%$.

Press DN respective after finish POS—R setting, there is POS--1、POS--M、POS--2、POS--L、 POS>L setting, please repeat above steps.

Press EXT to exit after finished.

3.9 Gyro sensor

Setting method:

Press ENT key in main interface to get twinkling main menu, then press UP or DN until flash FUNCTION appears, press ENT to enter function menu. And then Press UP or DN, it will come out bright GYRO, press ENT to enter MODE MENU surface, then press R or L to select Manual setting or Automatic setting



1. : Manual setting

Select Manual setting by press R or L key, press DN it will appears Switch selection, please select the switch you want, the default switch is MIX.

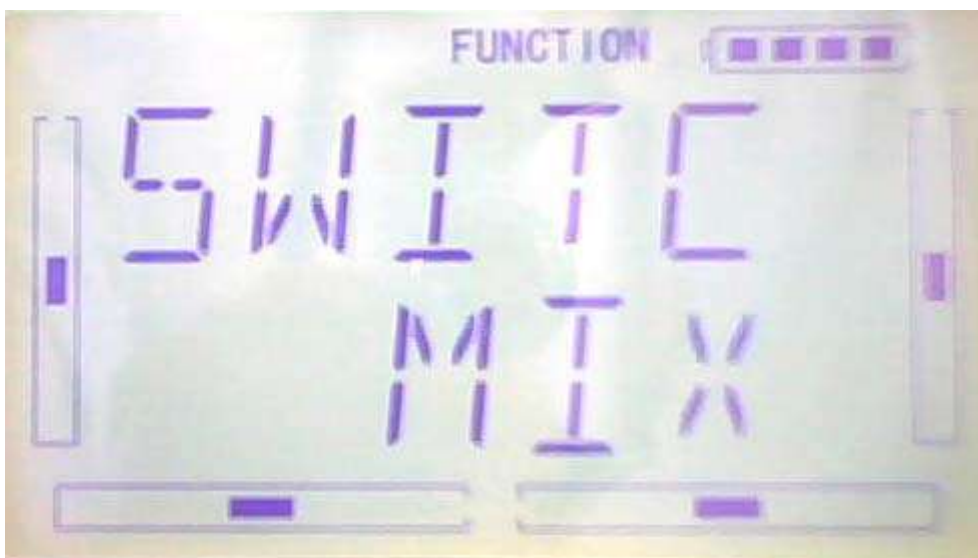

Switch value 0 will be show after press DN, press R or L to change the value. If the gyro used has two modes of NOR and AVCS, AVCS activated when above 50.0%. in AVCS mode, the bigger the value is, the bigger the gyro sensor gain will be. NOR will be activated when the value is less than 50.0%, In NOR mode, the smaller the value is, the bigger the sensitivity will be.



Press DN after POS 0 setting there will be appears POS 1 and POS 2 setting, please refer to steps of POS 0 setting.

Press EXT to exit after finish.

2 Automatic setting

This function can alter in different sensitivity automatically on flight mode. (at first please make flight mode activated, refer to 2.9 setting)

Press R or L to select Automatic setting in Mode menu interface.

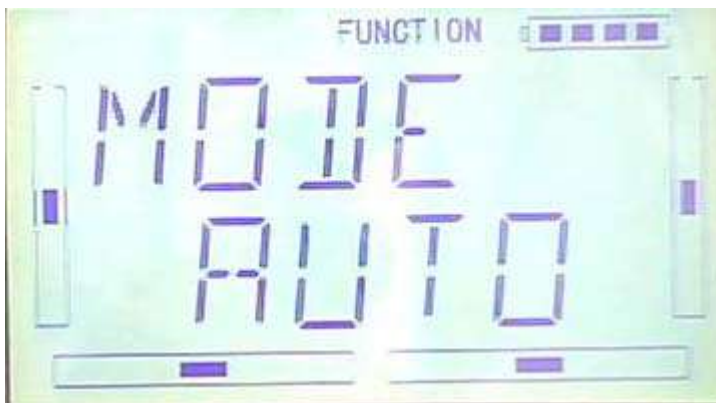

Press DN to enter FM 0 mode of auto setting, , press R or L to set the value. If the gyro used has two modes of NOR and AVCS, AVCS activated when above 50.0%. in AVCS mode, the bigger the value is, the bigger the gyro sensor gain will be. NOR will be activated when the value is less than 50.0%, In NOR mode, the smaller the value is, the bigger the sensitivity will be.



Press DN after FM 0 setting there will be appears FM 1 and FM 2 setting, please refer to steps of FM 0 setting.

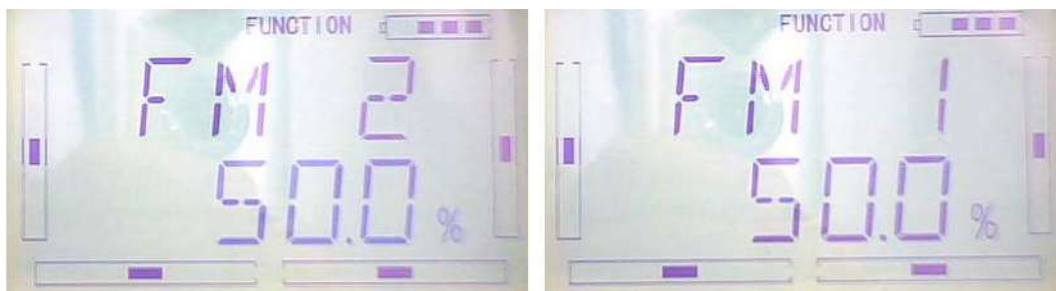

Press EXT to exit after finish.

3.10 Governor

Governor should be set at “Device Output” (Refer to “2.10 Device Output”).

The control proportion of governor can be separately set in various flight modes. For the absolute revolution amount, please set in external governor. The amount shown in DEVO-7’s governor is just a percentage for reference. The actual revolution should be read in the external governor.

Setting method:

Press “ ENT” button on the main interface until get flashing main menu. Press UP or DN button to when “ FUNCTION” flash, then press “ENT” to the function menu. Press UP or DN button to until “GOVER” flash, press ENT button to flight mode interface, press R or L to set the amount.

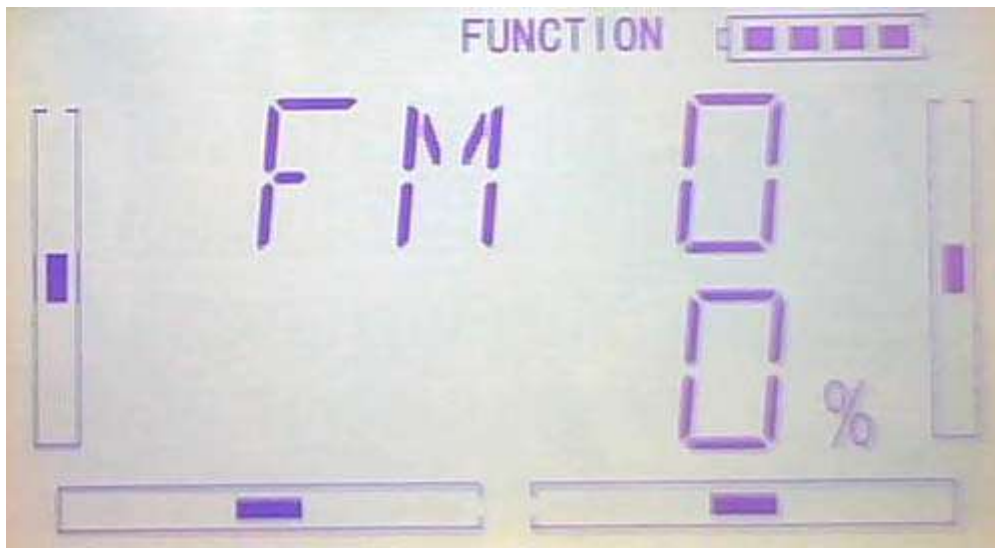

Setting the amount of FM 0: press R button, the amount to decrease the amount within -125%, press L button to increase the amount up to +125%.

Press DN button when finishing FM 0 setting and then go to the setting interface of FM 1 and FM 2. The setting methods are the same.

After finished, press EXT to exit.

3.11 Aileron to Rudder Mix

This function is possible to execute the mix of aileron to rudder, which is controlled by switch.

Setting method:

Press "ENT" button on the main interface until get flashing main menu. Press UP or DN button to when "FUNCTION" flash, then press "ENT" to the function menu. Press UP or DN button to until "AI--RU" flash, press ENT button to Pos 0 left setting.

1) Pos 0 left setting:

Press R or L button to change the value of rudder mix when the aileron stick towards left. The mix direction will be revised by changing the sign of plus or minus before the value. The adjustable range is $\pm 125\%$.

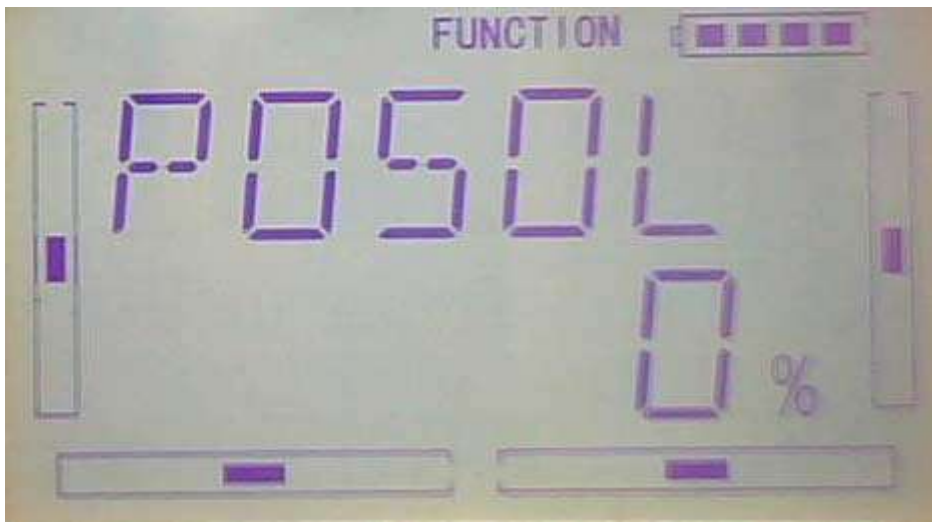

2) Pos 0 right setting:

After finishing Pos 0 left setting, press DN button to Pos 0 right setting.

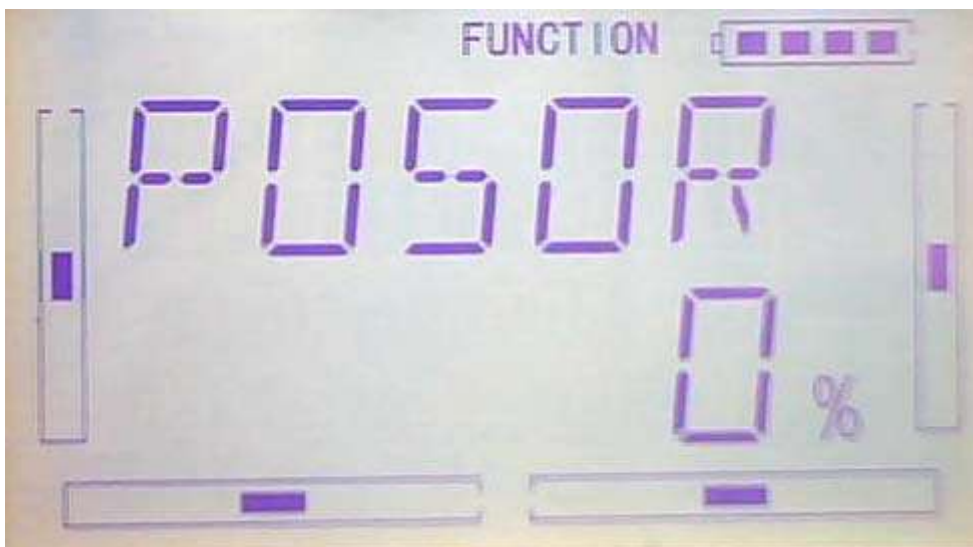

Press R or L button to change the value of rudder mix when the aileron stick towards right. The mix direction will be revised by changing the sign of plus or minus before the value. The adjustable range is $\pm 125\%$.

3) Pos 1 setting: the same as Pos 0.

Press DN button after finished Pos 0 setting. Then go to Pos 1 left and Pos 1 right settings. The setting methods are the same.

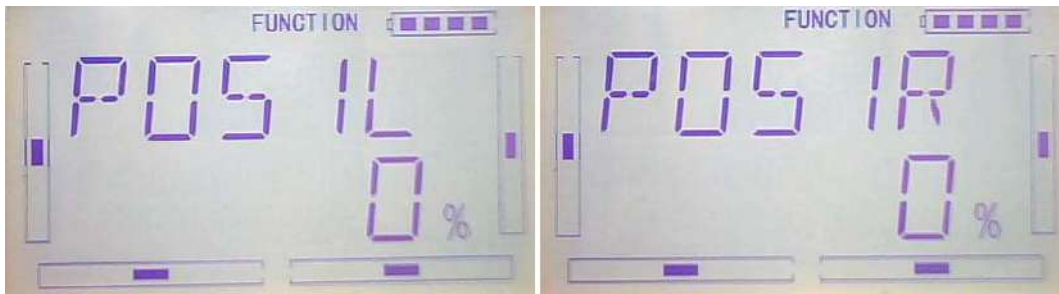

4)Throttle stick setting

After finished the above setting, press DN button to throttle stick setting.

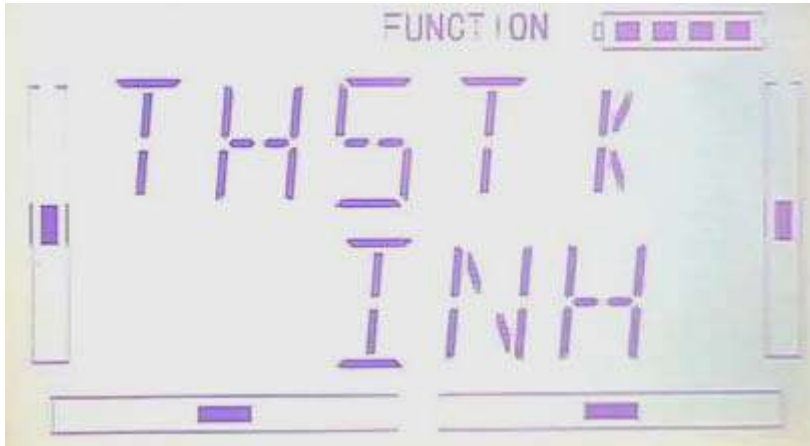

The switch between Pos 0 and Pos 1 can be realized by setting the position of throttle stick. Press R or L button to set the position amount of throttle stick or inhibit. The default setting is Inhibit. The adjustable range is 0.0-100.0%.

5)Switch setting

After setting the throttle stick, press DN button to “switch” setting interface. Current status will be shown.

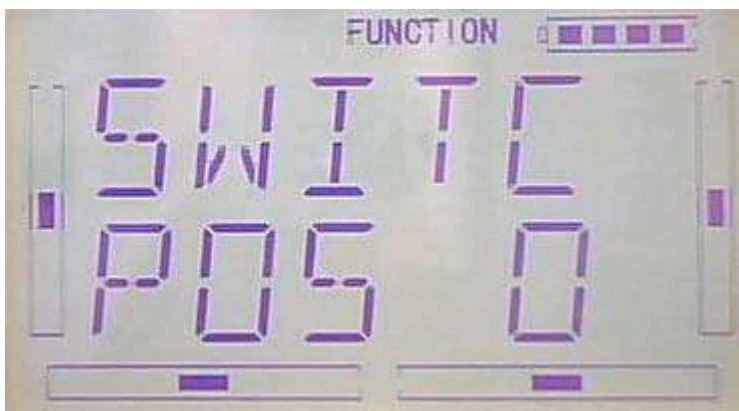

Press ENT button to “And” interface. There are “inhibit” and “active”. Press R or L to select the desired one. If two or more switches, “active” should be selected.



After above finished, press DN button to get the switch settings including FM 0, FM 1, FM 2 , FPNRM, FPMID, FPLND, D/R, HOLD and GEAR.



Press UP or DN to select the desired switch; press R or L to set it “inhibit” or “active”.

Press EXT to exit after finished.

3.12 Elevator to flap mix

This function is used to execute the mix of elevator to flap.

Setting method:

Press “ENT” button on the main interface until get flashing main menu. Press UP or DN button to when “FUNCTION” flash, then press “ENT” to the function menu. Press UP or DN button to until “AI--RU” flash, press ENT button to the setting of Pos 0 left.

1) Pos 0 up setting

Press R or L button to change the value of flap mix when the elevator stick pushes up. The mix direction will be revised by changing the sign of plus or minus before the value. The adjustable range is $\pm 125\%$.



2) Pos 0 down setting

After finished Pos 0 up setting, press DN to get to Pos 0 down setting



Press R or L button to change the value of flap mix when the elevator stick pulls down. The mix direction will be revised by changing the sign of plus or minus before the value. The adjustable range is $\pm 125\%$.

Press DN button after finished the setting of Pos 0. Then go to the setting of Pos 1 up and Pos 1 down. The setting method is the same.

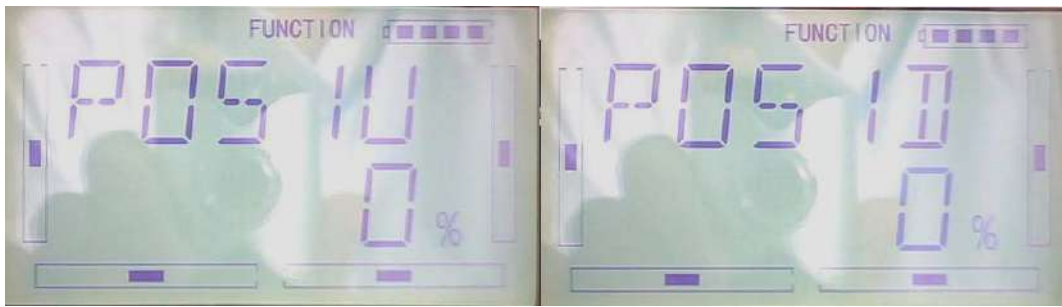

3)throttle stick setting:

After finished the above setting, press DN button to throttle stick setting.

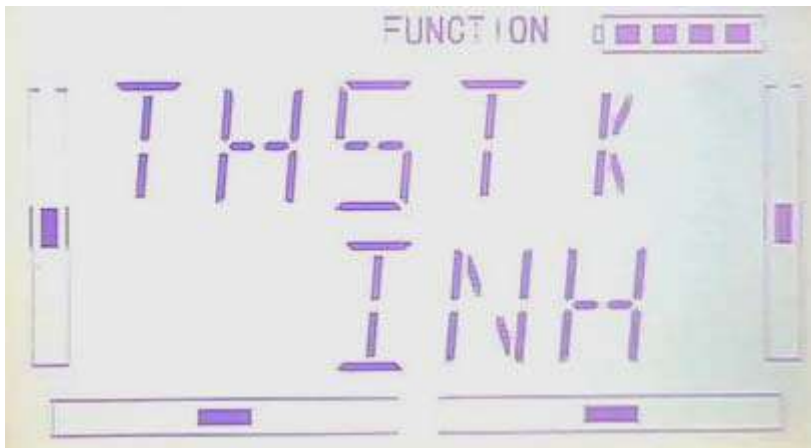

The switch between Pos 0 and Pos 1 can be realized by setting the position of throttle stick. Press R or L button to set the position amount of throttle stick or inhibit. The default setting is Inhibit. The adjustable range is 0.0-100.0%.

4) Switch setting

After setting the throttle stick, press DN button to "switch" setting interface. Current status will be shown.

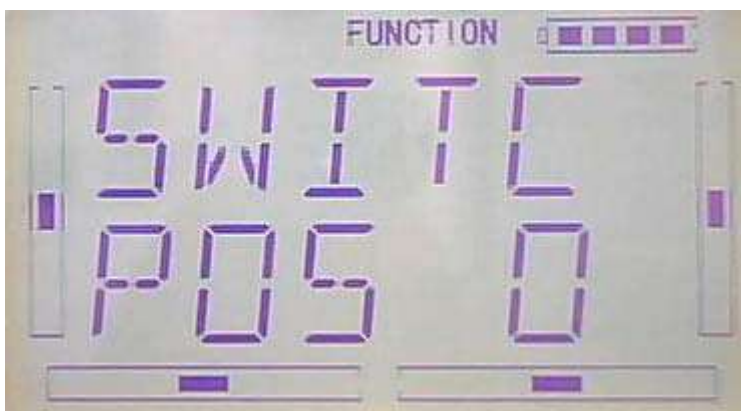

Press ENT button to "And" interface. There are "inhibit" and "active". Press R or L to select the desired one. If two or more switches, "active" should be selected.



After above finished, press DN button to get the switch settings including FM 0, FM 1, FM 2 , FPNRM, FPMID, FPLND, D/R, HOLD and GEAR.



Press UP or DN to select the desired switch; press R or L to set it “inhibit” or “active”.

Press EXT to exit after finished.

3.13 Rudder to aileron/elevator mix

This function is used to execute the mix of rudder to aileron/ elevator. It will help eliminate waver or shake caused by rudder stick operation.

Setting method:

Press “ENT” key to enter Main Menu, press UP or DN until “FUNCTION” flash , and then Press “ENT” key to enter Function Menu; Press UP or DN button until “RU--AE” becomes flash. Press ENT to enter the setting interface of Pos 0 left.



1) Elevator setting

1.1) Pos 0 left setting: press R or L button to change the value of elevator mix when the rudder stick towards left. The mix direction will be revised by changing the sign of plus or minus before the value. The adjustable range is $\pm 125\%$.



1.2) Pos 0 right setting: After finish Pos 0 left setting, press DN to get to pos 0 right setting. Press R or L button to change the value of elevator mix when the rudder stick towards right. The mix direction will be revised by changing the sign of plus or minus before the value. The adjustable range is $\pm 125\%$.

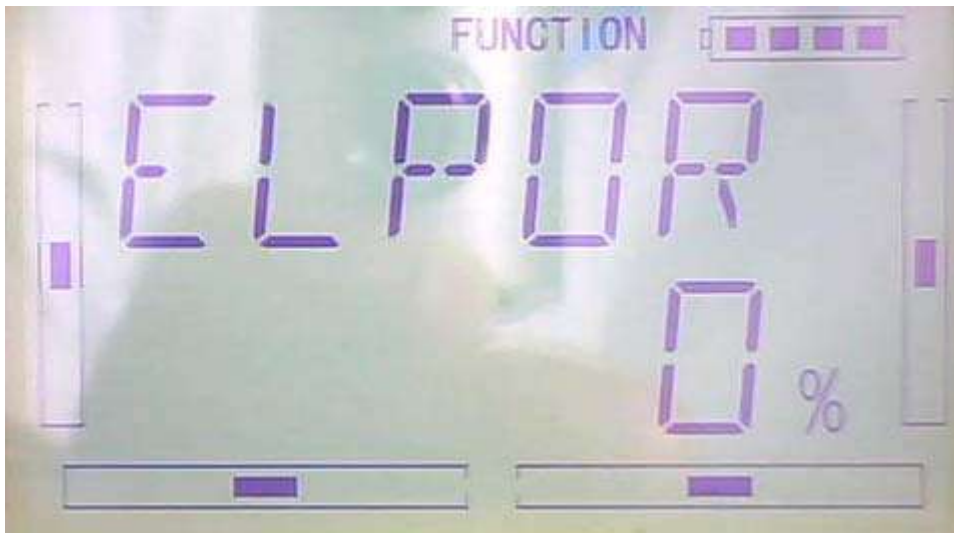

1.3) Pos 1 left setting: After finish Pos 0 setting, press DN to get to pos 1 left setting. Press R or L button to change the value of elevator mix when the rudder stick towards left. The mix direction will be revised by changing the sign of plus or minus before the value. The adjustable range is $\pm 125\%$.



1.4) Pos 1 right setting: After finish Pos 1 left setting, press DN to get to pos 1 right setting. Press R or L button to change the value of elevator mix when the rudder stick towards right. The mix direction will be revised by changing the sign of plus or minus before the value. The adjustable range is $\pm 125\%$.



2) Aileron setting

2.1) Pos 0 setting: same as "1.1, 1.2 Pos 0" setting.

2.2) Pos 1 setting: same as "1.3, 1.4 Pos 0" setting.

3) Throttle stick setting

The switch between Pos 0 and Pos 1 can be realized by setting the position of throttle stick.

Setting: After finished the aileron setting, press DN button to go to throttle stick setting. Press R or L button to set the position amount of throttle stick. The default setting is Inhibit. The adjustable range is 0.0-100.0%.

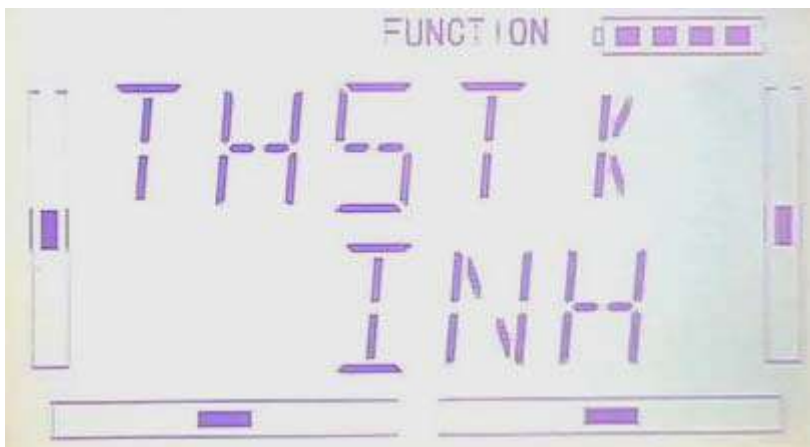

4) switch setting

After setting the aileron, press DN button to "switch" setting interface. Current status will be shown.

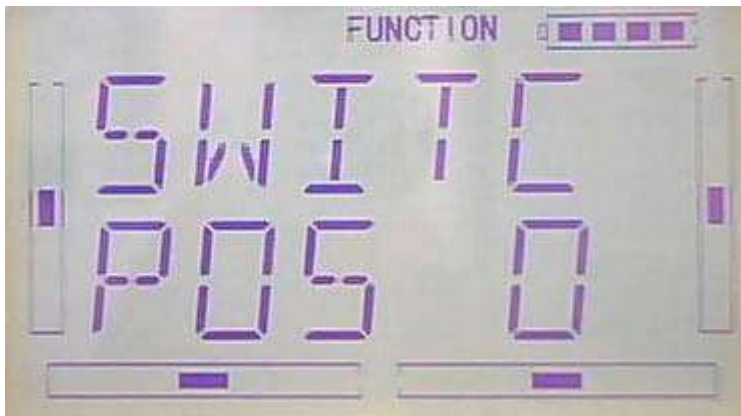

Press ENT button to “And” interface. There are “inhibit” and “active”. Press R or L to select the desired one. If two or more switches, “active” should be selected.



After above finished, press DN button to get the switch settings including FM 0, FM 1, FM 2 , FPNRM, FPMID, FPLND, D/R, HOLD and GEAR.



Press UP or DN to select the desired switch; press R or L to set it “inhibit” or “active”. Press EXT to exit after finished.

3.14 (FLAPS)

This function can modify some effects on elevator. It is possible to set three statuses of elevator and three statuses of flap, respectively, through three-way flap control switch.

Setting method:

press "ENT" key to get the flashing main menu. Press UP and DN keys until "FUNCTION" becomes flashing, then press "ENT" key to Function menu. Press UP or DN key until "FLAPS" becomes flashing; Press ENT key, you will find the ELEV normal setting under the FLAPS interface.

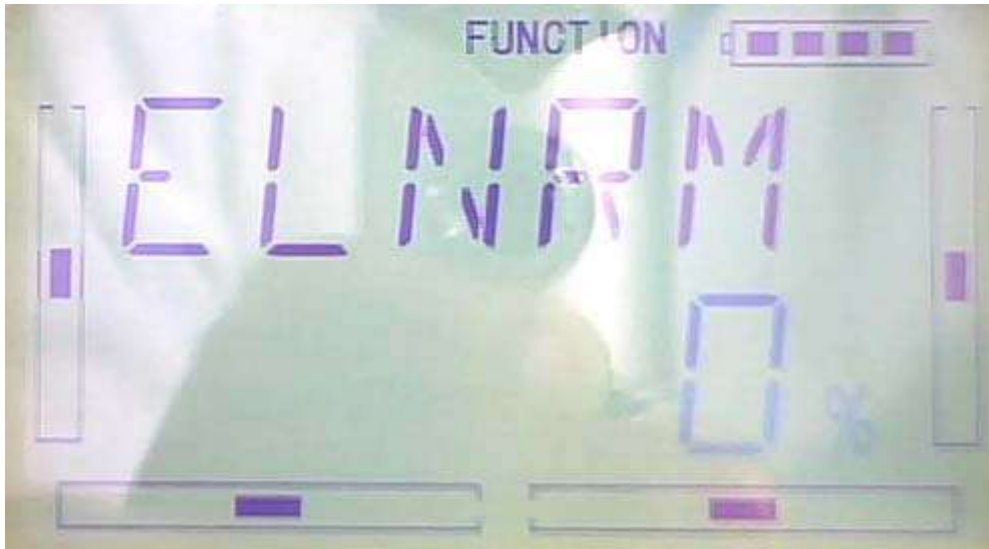

1) Elevator setting

There are three options: Normal, Midpoint and Land.

1.1) Normal position: Press R or L keys to change the ELEV gyro mix amount. It is possible to change the direction by altering D or U before the amount. The default setting is 0%, and the adjustable range is U125% to D125%. (see illustration below)

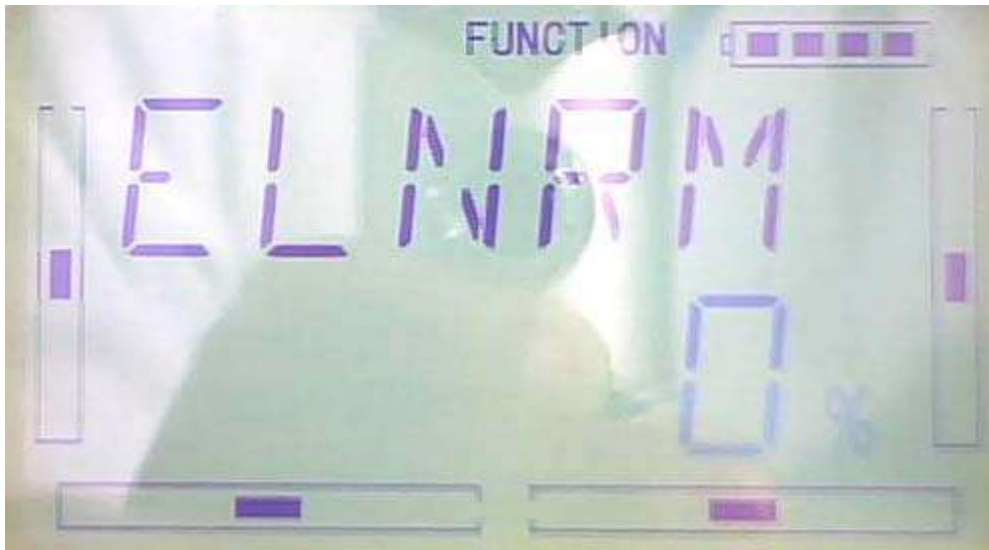

1.2) Midpoint

The setting is same as above.

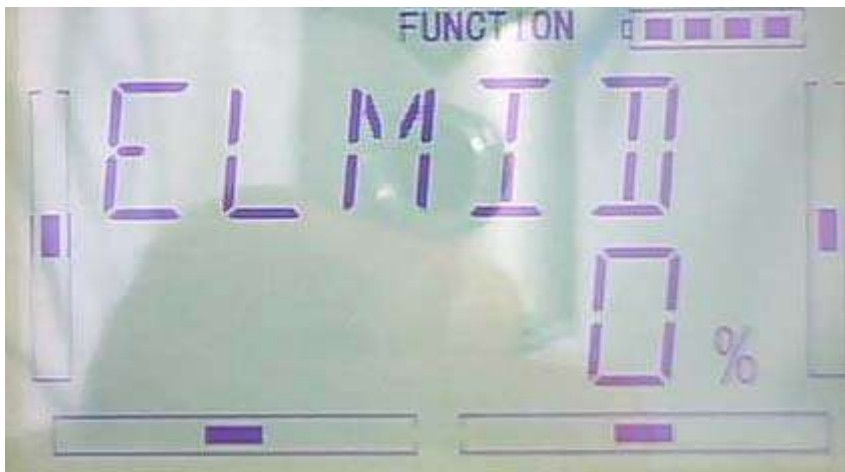

1.3) Land

The setting is same as above.



2) Flap setting

The setting for Flap is same as Elevator.

3) Auto land

After setting of Flap ,press DN enter to Auto Land interface.

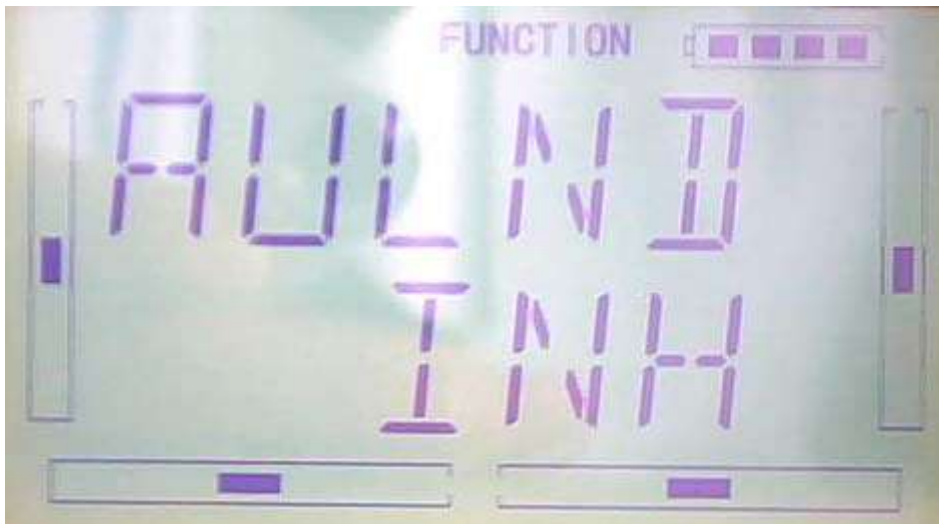

Press R or L to choose Inhibit and Active.Press Active another sub menu Throttle will be shown under Auto Land.

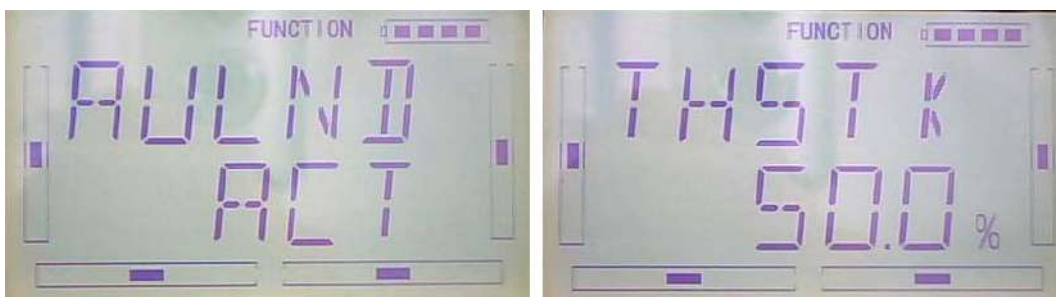

3.1) Throttle stick position setting :Press R or L change the data to set the throttle stick position. The adjustable range is 0.0-100.0%.

3.2) Flight mode setting: Auto landing switch can be set in a certain flight mode. This setting should be previously set in Wing Type at Model Menu. Refer to “2.10Wing Type”.

3.2.1 Flight mode Zero setting:

After finished the setting of throttle stick position,press DN to flight mode zero setting interface,press R or L can select Normal, Midpoint, and Land.“Normal” setting is manually control.



3.2.3 Flight mode 1 setting: After finished the setting of flight mode zero setting,press DN to flight mode--setting interface,press R or L can select Normal, Midpoint, and Land.“Normal” setting is manually control.

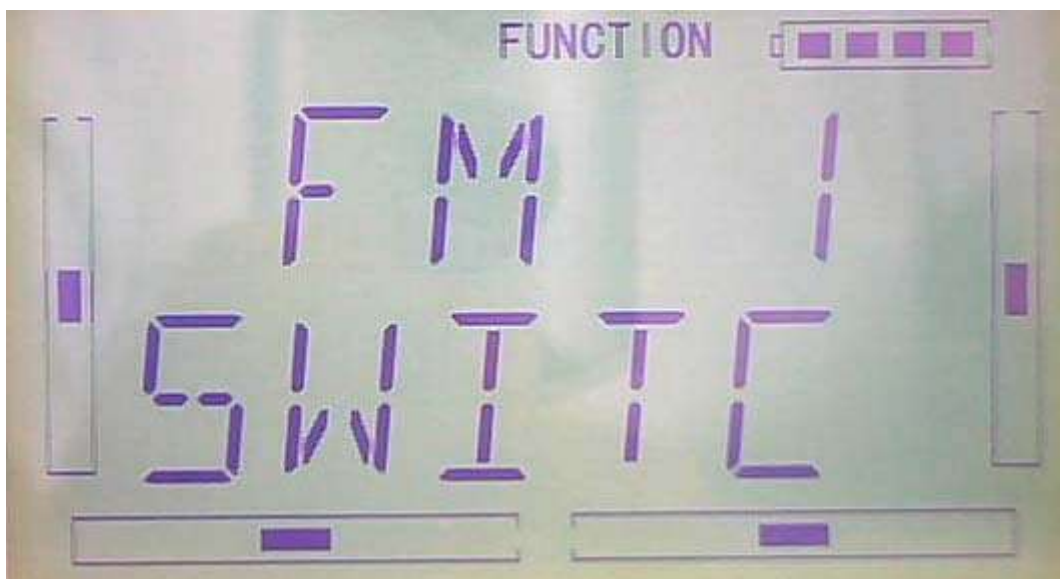

3.2.3 Flight mode 2 setting: After finished the Flight mode 1 setting,press DN to flight mode 2 setting interface,press R or L can select Normal, Midpoint, and Land.“Normal” setting is manually control.

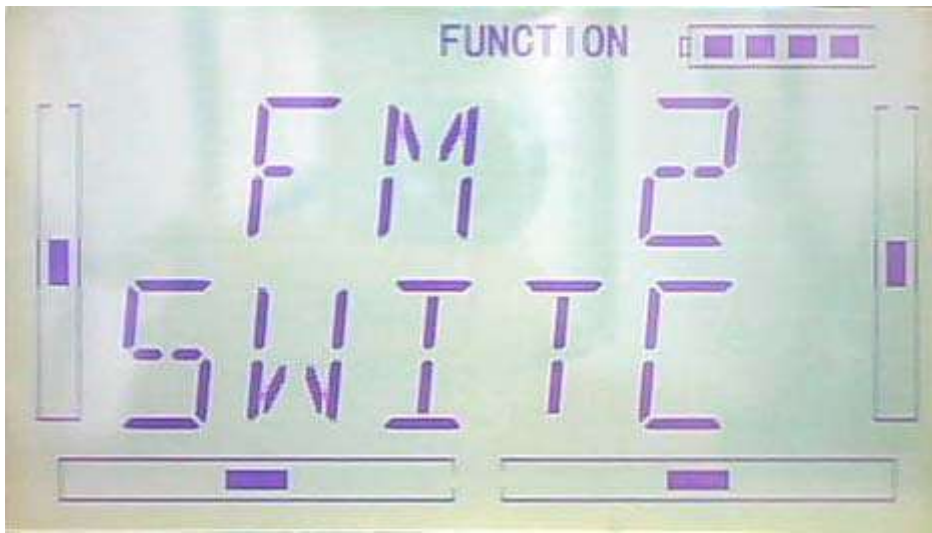

3.15 Aileron to flap mix

This function can execute the mix of aileron to flap, and can also set switch. The flap dual channels should be previously set in Wing Type at Model Menu (Refer to “2.12 Wing Type”).

Setting method:

press “ENT” key to get the flashing main menu. Press UP and DN keys until “FUNCTION” becomes flashing, then press “ENT” key to Function menu. Press UP or DN key until “AI--FL” becomes flashing; Press ENT key, you will find the Left at Pos 0 setting under the AI--FL interface.

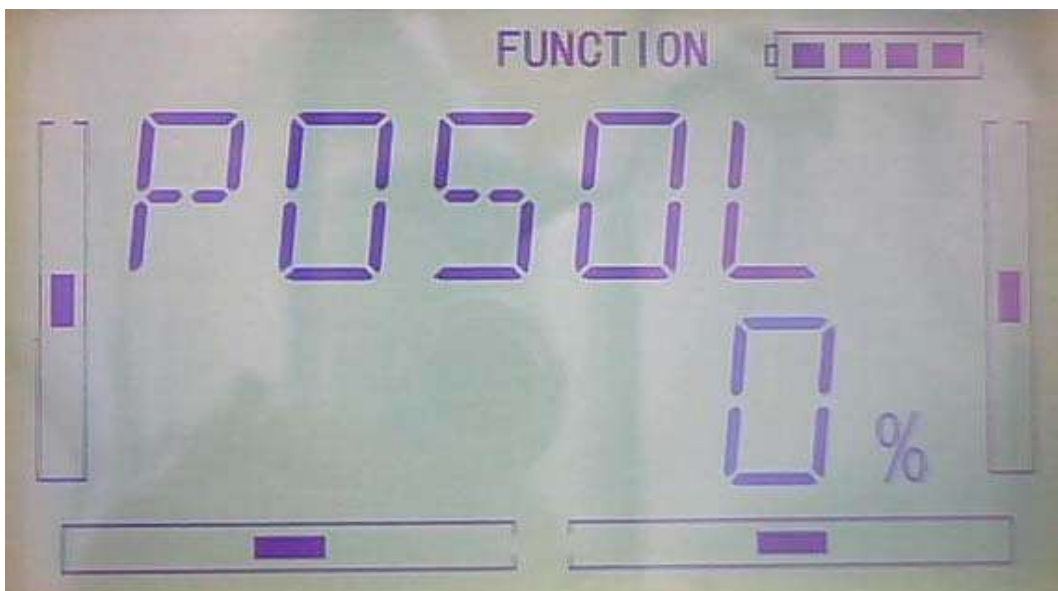

1) Pos 0 setting

1.1 Left at Pos 0

Press R or L change the data to change the leftward mix value of aileron to flap.

“+”or“—” will change the mix direction.The adjustable range is $\pm 125\%$.

1.2) Right at Pos 0

After set of Left at Pos 0, Press DN to Right at Pos 0. Press R or L change the data to change the rightward mix value of aileron to flap. “+”or“—” will change the mix direction.The adjustable range is $\pm 125\%$.

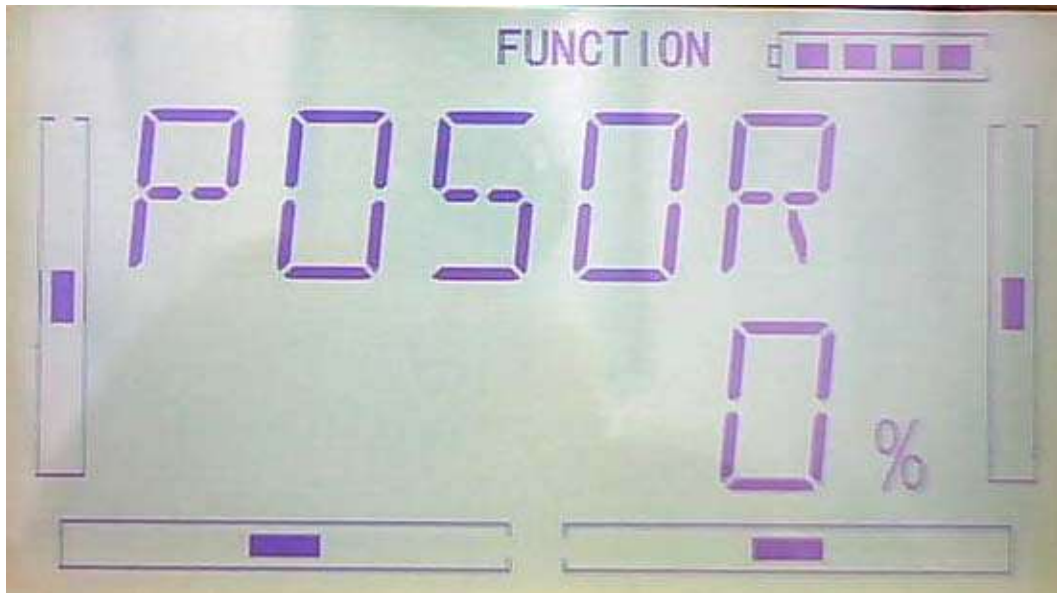

2) Pos 1 setting leftward.

The setting is same as the above.



2.1)Pos 1 setting Rightward.

The setting is same as the above.



3) Throttle Stick setting

The switch between Pos 0 and Pos 1 can be realized by setting the position of throttle stick.

Setting: After setting Pos 1, Press DN to Throttle stick setting, Press R or L can set the position amount of throttle stick. The default setting is Inhibit. The adjustable range is 0.0-100.0%.

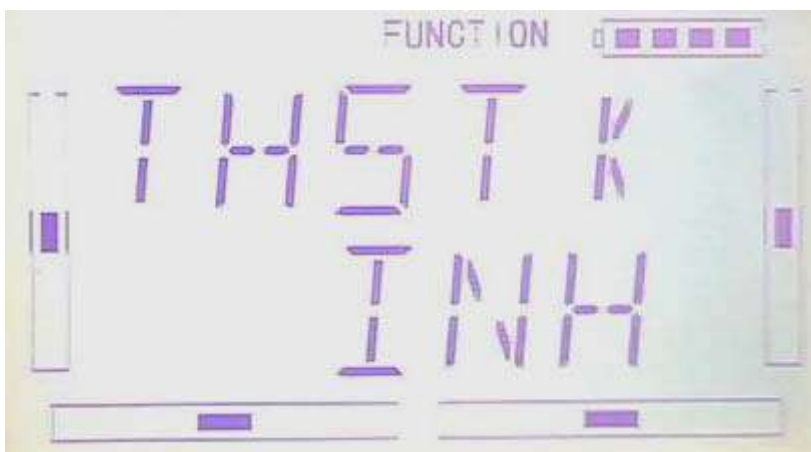

4) Switch setting

After setting of Throttle stick, press DN enter "Normal" interface and the "Normal" will show on the screen and the status of "Normal".

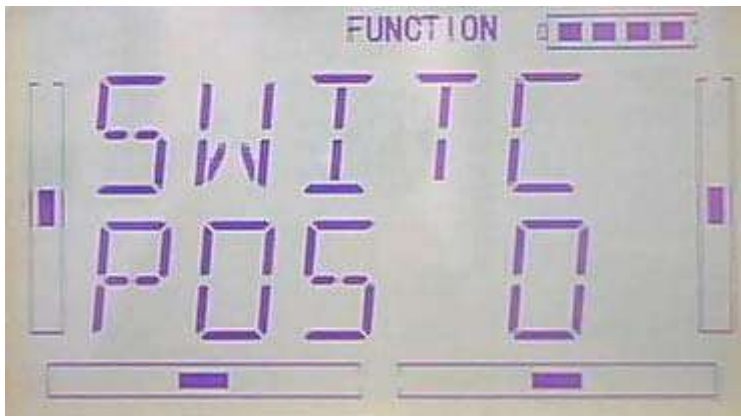

Press ENT to get “and” interface can be choose from Inhibit and Active.Press R or L choose Inhibit and Active.If choose above two switch(include two switch) can choose Active.



After finished the above steps, Press DN key will see switch option as follows: FM 0、FM 1、FM 2、FPNRM、FPMID、FPLND、D/R、HOLD、GEAR。



Press UP or DN to choose the available switch,Press R or L can choose Inhibit and Active,Press EXT after finished.

3.16(PRGMX)

There are total eight sets of Program Mix. It is possible to freely set the channels and values which you want to mix.

Setting method:

press "ENT" key to get the flashing main menu. Press UP and DN keys until "FUNCTION" becomes flashing, then press "ENT" key to Function menu. Press UP or DN key until "PRGMX" becomes flashing; Press ENT key, you will find the Program mix setting . (the factory default setting is Inhibit). Take Program Mix 1 as an example to show how to use.



A Setting method for Normal in Program Mix 1

After finished above setting in the Program mix setting Press L enter Normal setting interface.



Press ENT key, pop up "All Servos Hold?" Click YES for all the servos will be locked at the current statuses; click Cancel for unlocked.



Press ENT to confirm, then enter to program mix—setting menu. The adjustment settings as follows: Master channel setting, Slave channel setting, position O, Position 1, Offset, throttle stick, switch etc.

1) Master channel setting. (see below illustration), Press R or L key can Select the desired channel. the channels are selectable: ELEV、AILE、THRO、RUDD、GEAR、FLAP、AUX2、OELEV、OAILE、OTHRO、ORUDD、AUX2.



2) Slave channel setting: Press DN after setting the master channel setting, then enter to the slave channel setting. see below illustration. Press R or L key, select the designed slave channel, the selectable channel as follows: ELEV、AILE、THRO、RUDD、FLPRL、FLAP、AUX2.

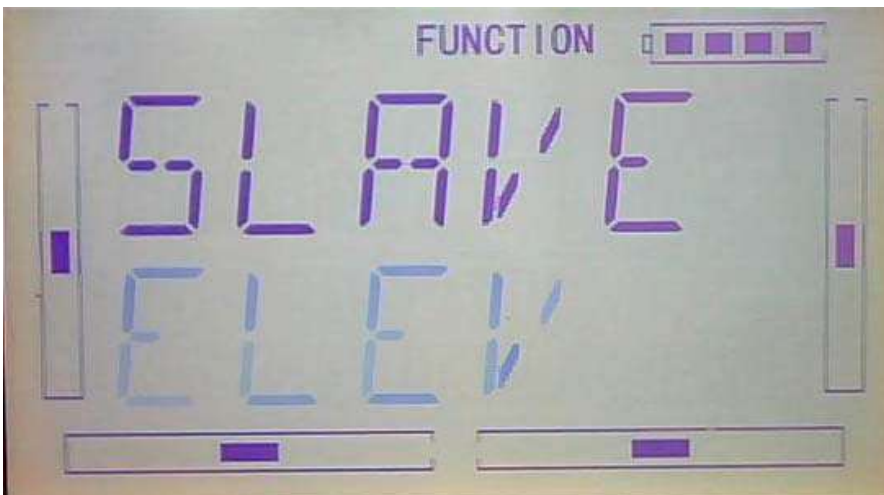

3) Position O setting

Take ELEV as master channel for example. Press DN after finished the slave channel setting. enter to the Position O setting interface.

3.1) Mix amount setting when elevator stick moved upward: Press R or L to decrease or increase, separately, the mix amount. It is possible to reverse mix direction through changing the plus or minus sign before amount. The adjustable range is $\pm 125\%$.

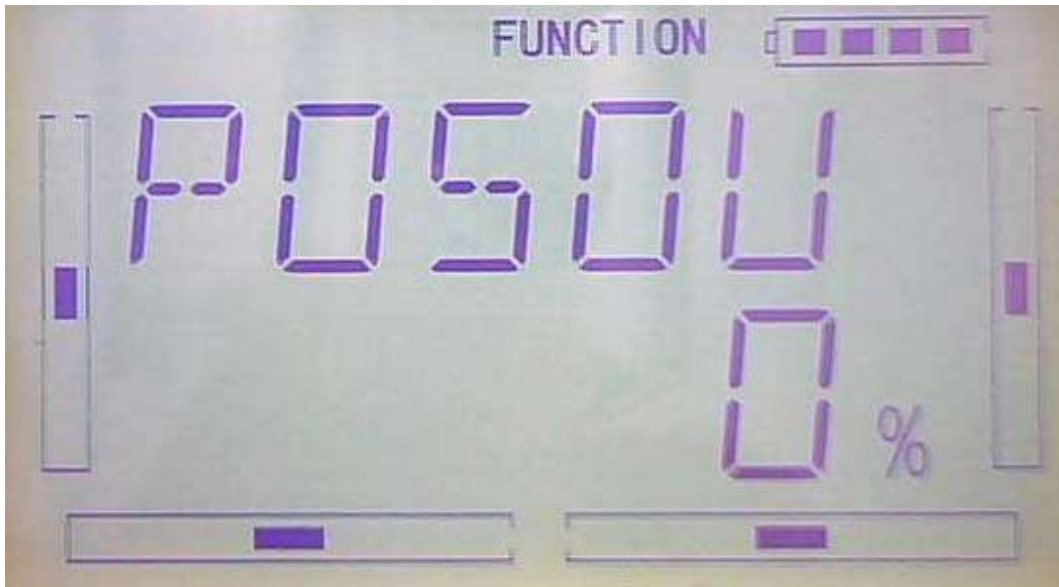

3.2) Mix amount setting when elevator stick moved downward: Press R or L to decrease or increase, separately, the mix amount. It is possible to reverse mix direction through changing the plus or minus sign before amount. The adjustable range is $\pm 125\%$.

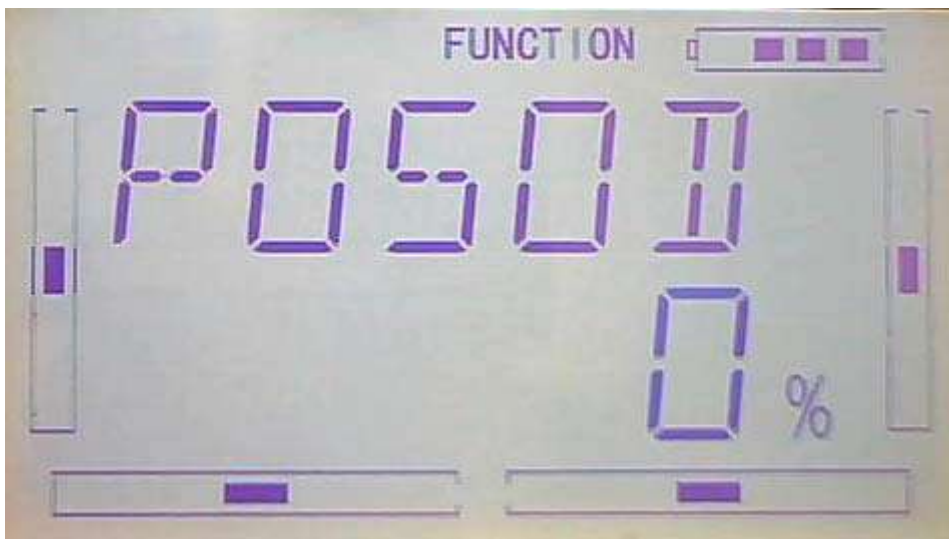

3.3) Pos 1 setting: The setting is same as above.

4) Offset setting: can start from some position through switch stick in "slave channel" interface to set the mix.

The setting is same as above.



5) Press DN enter to throttle stick setting after finished the Offset. Press R or L key can set the stick position value. The default setting is "inhibit". The adjustable range is 0.0-100.0%.

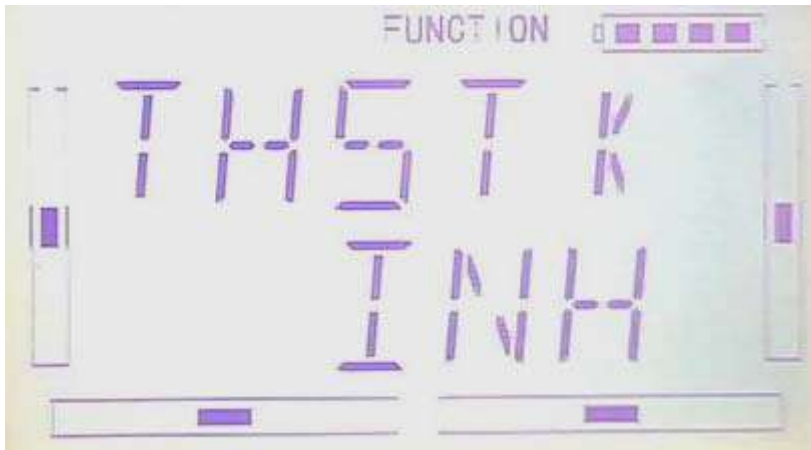

6) switch select: Press DN after set of throttle stick, enter to the switch setting interface, and the status will show on the screen.

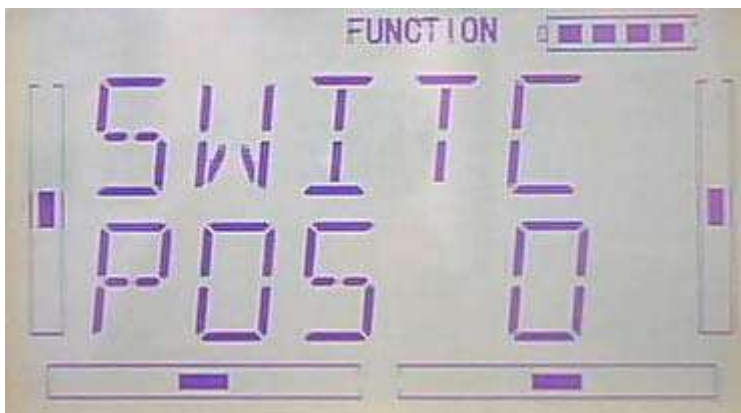

Press ENT to “and”interface you have two choice: inhibit and Active. Press R or L to select Inhibit or Active. Press Active when you select above two switch(include 2 switch) control.



Then press DN to choose from: FM 0、 FM 1、 FM 2、 FPNRM、 FPMID、 FPLND、 D/R、 HOLD、 GEAR。



Press UP or DN select the switch. Press R or L select Inhibit or Active. Press EXT to confirm and exit.

B press “ENT” key to get the flashing main menu. Press UP and DN keys until “FUNCTION” becomes flashing, then press “ENT” key to Function menu. Press UP or DN key until “PRGMX” becomes flashing; Press ENT key, you will find the Program mix setting . (the factory default setting is Inhibit). Press R or L key to select the Inhibit ,Normal,Curve.

Take Program Mix 1 as an example select the Curve to show how to use.



Press ENT key, pop up “All Servos Hold?” Click Yes for all the servos will be locked at the current statuses; click Cancel for unlocked. Press ENT to master channel select interface.

1) Master channel setting: see below illustration, press R or L key, select the master channel and can select as follows: ELEV、AILE、THRO、RUDD、GEAR、FLAP、AUX2、OELEV、OAILE、OTHRO、ORUDD、AUX2



2) Slave channel setting: Press DN after setting the master channel setting, then enter to the slave channel setting. see below illustration. Press R or L key, select the designed slave channel, the selectable channel as follows: ELEV、AILE、THRO、RUDD、FLPRL、FLAP、AUX2.

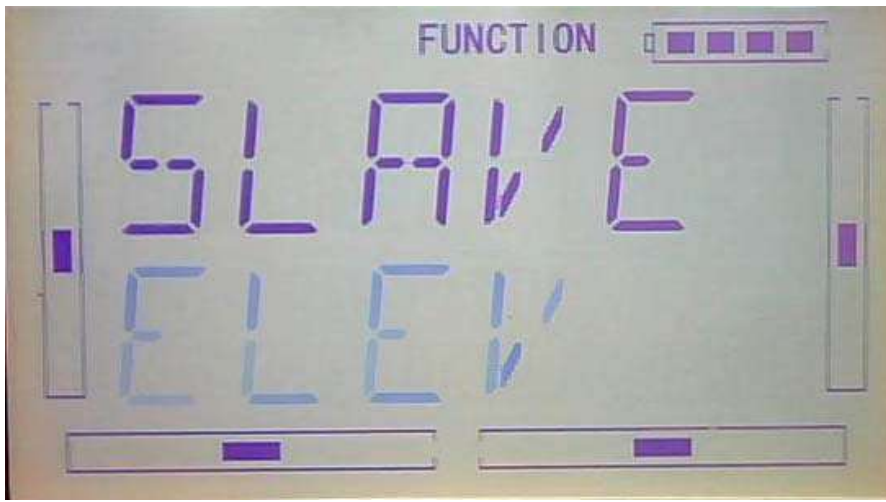

3)Position setting:Press DN after finished the slave channel setting.enter to the Position setting interface.(see below illustration)

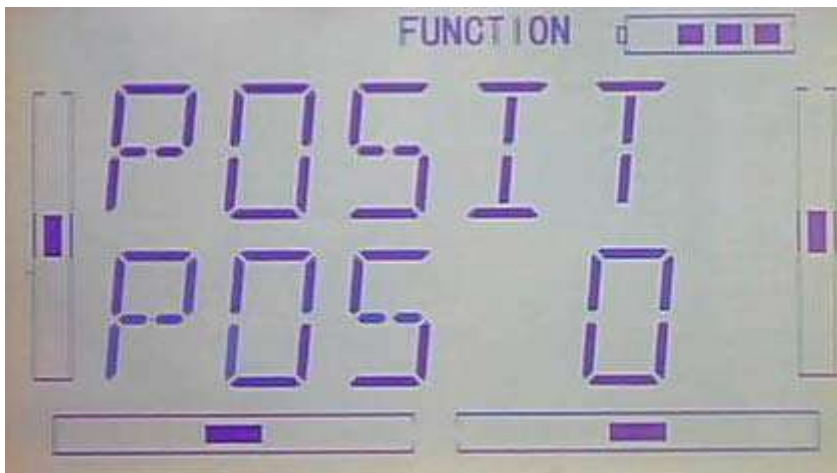

4)Exponetial curve:Press DN to confirm and enter EXP setting.see below illustration,press R or L, select EXP"ON""OFF". Press "ON" can make the curve circularity,press "OFF" for nonuse.



5)Point

Press DN to confirm after EXP setting enter to 7 points.Press R or L to select from any

of them: L、1、2、M、3、4、H7.



Press DN to confirm enter to Status setting.

6)Status:Press R or L same as below illustration can select from Inhibit or Active.if do not required to change the point data,select Inhibit(default setting is Inhibit).if require to change the data,select Active.

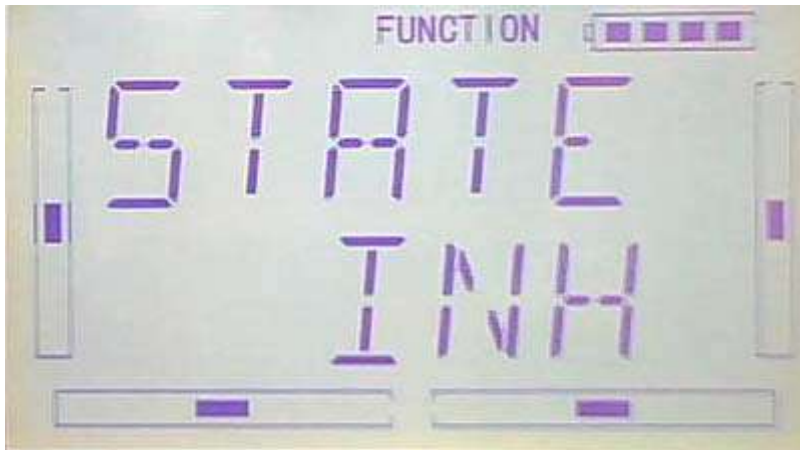

Press DN to confirm enter to Output setting.

7)Output: when the Point setting is ACT press DN enter to Output setting. See below illustration,Press R to decrease the data ,the Min. -100%, press L to increase the Output data, the MAX. +100%. Press R or L to adjust the data of +、- to reverse if the mix was reverse.



8) Throttle stick setting:press DN ket to enter to throttle stick setting interface after set the Output setting.Press R or L can select Stick position data.the default setting is "Inhibit",the adjustment range is 0.0-100.0%.

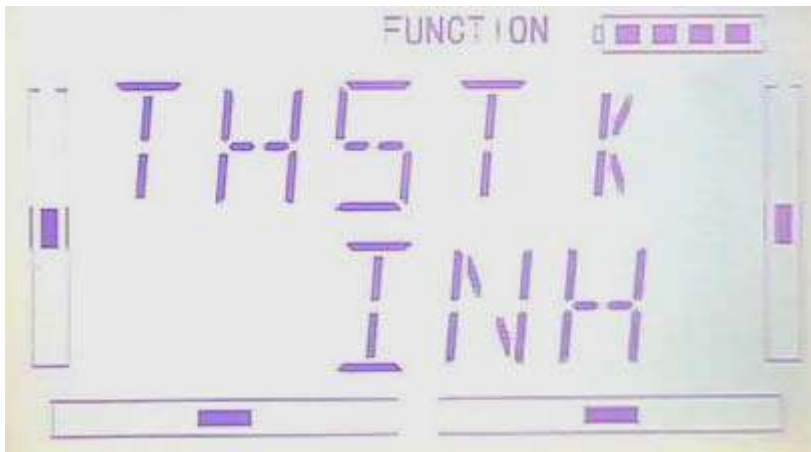

9) Switch select: Press DN after setting of throttle . enter to Switch setting interface,will display the currently status.



Press ENT to “and”interface you have two choice: inhibit and Active. Press R or L to select Inhibit or Active. Press Active when you select above two switch(include 2 switch) control.



Press DN to confirm the above setting will display Switch select as follows: FM 0、FM 1、FM 2、FPNRM、FPMID、FPLND、D/R、HOLD、GEAR。

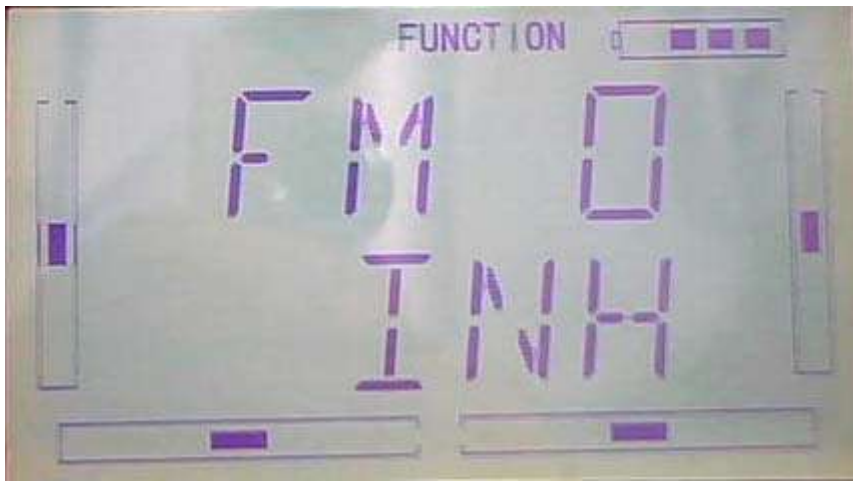

Press UP or DN to select in commission switch, press R or L key to select Inhibit or Active. Press EXT to confirm and exit.



3.17 (MONIT)

This function can display the current statuses and positions of all the channels' outputs, and check the current working status of each channel.

press "ENT" key to get the flashing main menu. Press UP and DN keys until "FUNCTION" becomes flashing, then press "ENT" key to Function menu. Press UP or DN key until "MONIT" becomes flashing; Press ENT key,



Click the “EXT” to exit after finished.

3.18 (Fail -Safe)

There are two possibilities for use if the transmission signal is under abnormal condition. The first one is to lock the last action data received; the second one is to execute the pre-set data which is pre-set. The default setting is Servo Hold.

Setting method:

press “ENT” key to get the flashing main menu. Press UP and DN keys until “FUNCTION” becomes flashing, then press “ENT” key to Function menu. Press UP or DN key until “SAFE” becomes flashing; Press ENT key, you will find the Fail safe, as follows: ELEV、 AILE、 THRO、 RUDD、 GEAR、 FLAP、 GYRO、 . Take the item Elevator as an example to explain.



Press R or L key to choose Hold or fail safe. If choose hold, last received lock out of control action data; If choose fail safe, perform the protection of out of control data set. The default setting is Servo Hold.

Then press DN to choose SAFE, press DN key enter to the Fail safe setting interface.



press R or L(if Elevator is at Servo Hold, and 0%) , decrease or increase, the position amount which centers on the neutral point of servo. The settable range is 125%, and 0% is the servo's neutral position.

Press DN to confirm enter other channel.

The setting methods for other channels are same as above

Click the "EXT" to exit after finished.

Note: checking whether all the actions when fail safe happened are correct is a must after the setting is finished. It is dangerous to use full throttle, especially after fail safe taken place.

3.19 (TRAIN)

Two DEVO-7 transmitters working together can execute the training function to meet the requirements for the beginner. The setting method is shown as below:

1) Data copy

First,using the wireless copy function of the two DEVO-7 transmitters.the model data saved in the trainer's transmitter can be transmitted to the trainee's to ensure the model parameters are exactly same.Regarding the copying method,,refer to "2.4 Model Wireless Copy"

2) Linkage

Insert the signal wire from the trainer's transmitter into the DSC socket of the trainee's transmitter. Turn on the transmitter and a linkage icon will be shown on the boot screen PC 0%(and MOD alternate display), shown as below. Find out the trainee's model data



linkage icon

Turn on the power of the trainer's transmitter, find out the trainee's model data, and let the trainer's transmitter fly the aircraft model normally, then turn off the power. Insert the other end of the digital signal wire into the trainer's.



3) Setting for training function channels

Trainee is available to get full or part of flight control power to the aircraft model via setting the training function channel in the trainer's DEVO-7. Below is the setting method:

Press ENT to show flash main menu. Press UP or DN until FUNCTION flash, repress ENT to enter function menu; Press UP or DN until Train flashing, press ENT to enter channel selection. Press UP or DN, selecting controlled channel, press R or L to change the controlling right of channel. INT is for "Inhibit; ACT is for being granted. Press EXT to exit after finished.

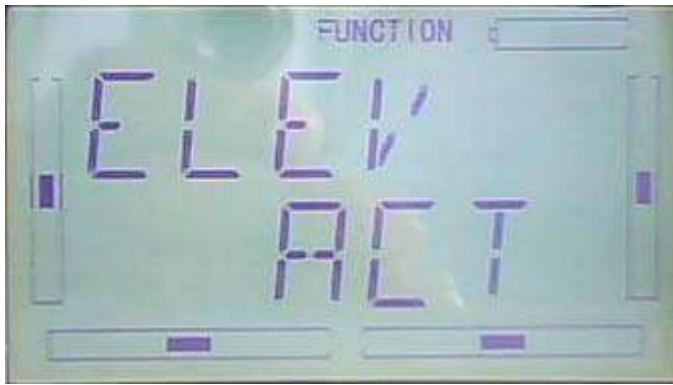

4) Usage method

The training switch should be work with the HOLD/TRN, showed is as belows,



During flying, if trainer pull TRN front and keep it, that means trainer already hand over the controlled right to trainee. At the same time, the output date of open interface should be the operated data of trainee. If trainer move away TRN, that means trainer will get back the operated right from trainee and operate the model.

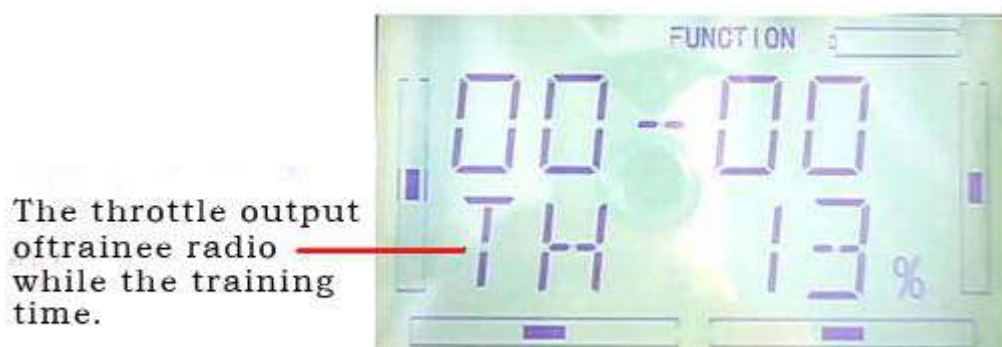

3.20 (TIMER)

here are two timers which can be set stopwatch and countdown, respectively. Each timer can be operated by switch.

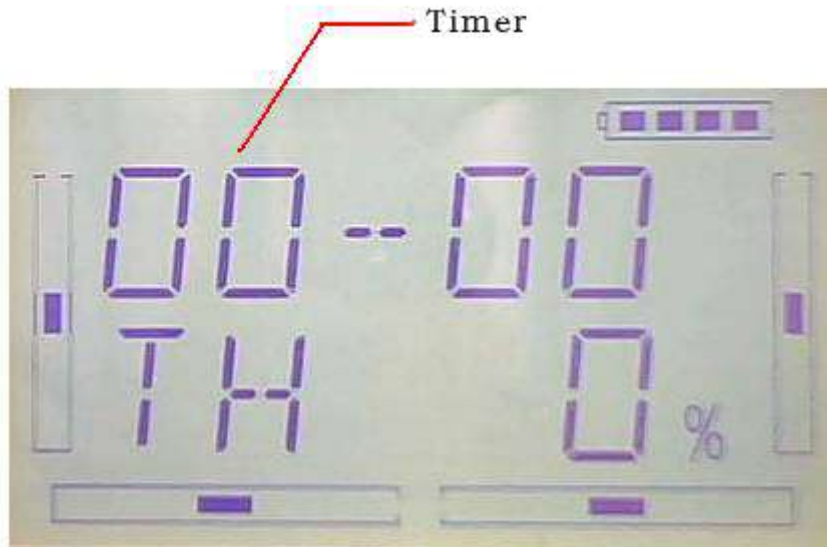

Press "ENT" to show flash main menu. Press "UP" or "DN" until "FUNCTION" flash then press "ENT" to enter function menu; Press UP or DN, make interface showed flash "TIMER" menu, press "ENT" to enter type selection. There are stopwatch and countdown. Press R or L to select.

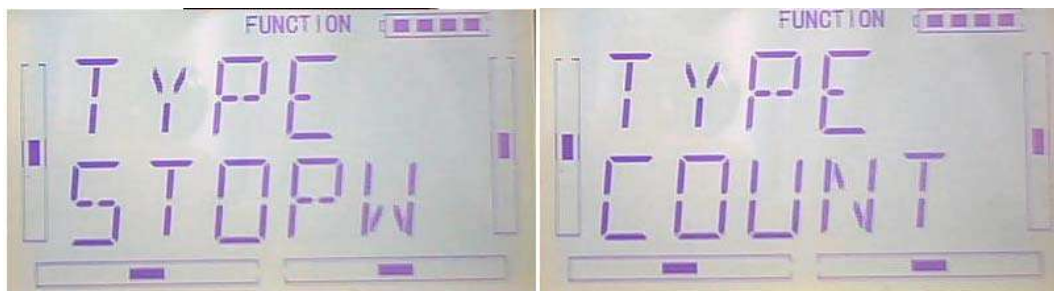

A) Stopwatch setting, the following interface for stopwatch, press EXT to exit



The max range of stopwatch is from 0 to 59 min 59 sec

B) Countdown setting: press R or L on press the above interface to select countdown setting as following;

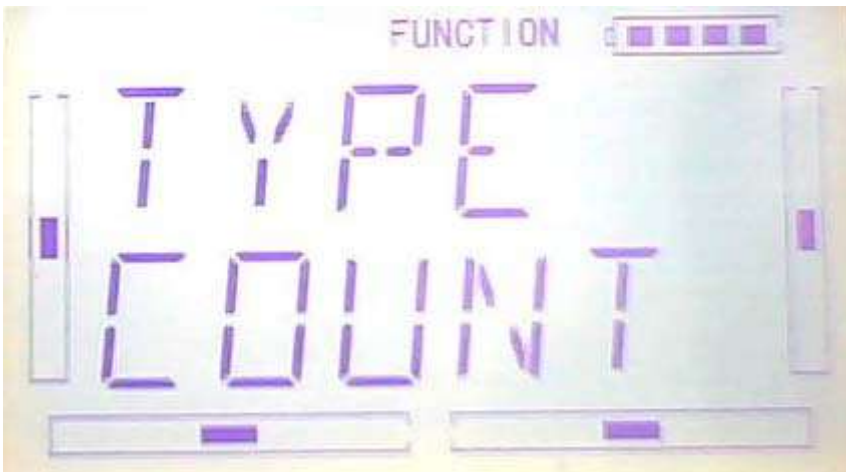

Press DN on above interface to enter countdown

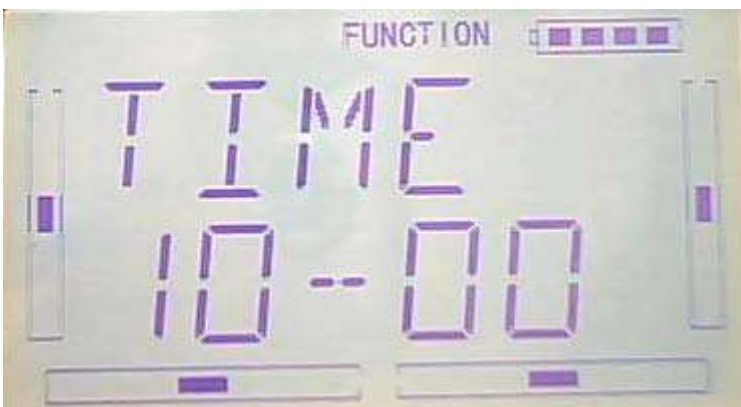

Press R or L to set countdown. The countdown rang of is from 00:05-59:55.

C) usage method

Press UP on " on" interface AN to start on the first time, repress UP to stop; press DN, timer is the original 0

stopwatch interface

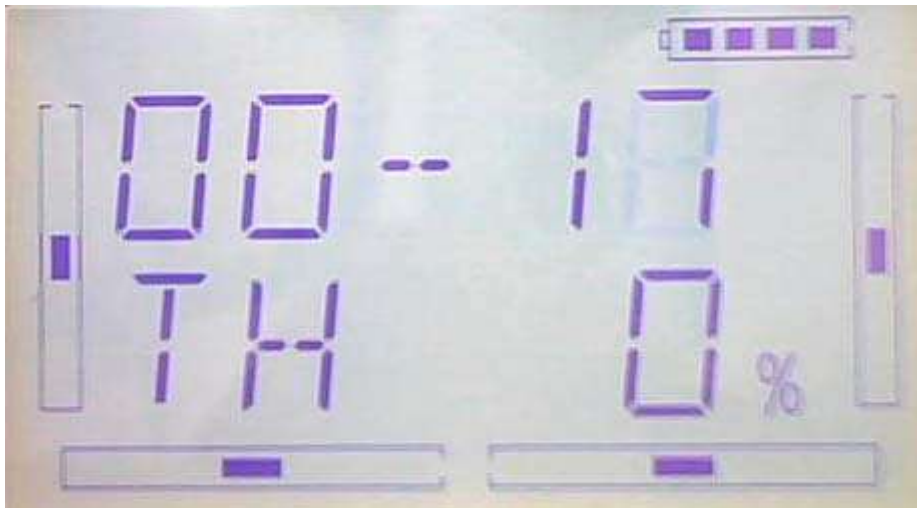

countdown interface



Part four: Upgrade interface

Devo 7 can upgrade the program via UP02

Enter the interface: Turn off the transmitter first, then press the EXT and turn on the power as below :



Turn on the power and the LCD display as below, it means the radio go into the upgrading status.

Insert the UP02's ϕ 3.5 Audio to the DSC jack. As below:



Insert UP02's USB to the PC.



Run the UP02 program in the PC. Details please follow the UP02 upgrade manual.

