

devention
DEVO 7E



DEVO 7E

7-channel micro computer system

DEVO 7E transmitter Users Manual

Note: Please read the manual thoroughly before use and keep it in a safe place for the future reference .

Contents

Part one: General information

1.0 General information	2
1.1 Important statements	2
1.2 Safety needing attention	2
1.3 Attention before flight	2
2.0 Features	3
2.1 Transmitter DEVO 7E	3
2.2 DEVO-RX701 Features	3
3.0 Specification	3
3.1 DEVO 7E transmitter specification	3
3.2 Receiver specification	3
4.0 Definition of DEVO 7E	4
4.1 Front Panel View	4
4.2 Rear View	4
4.3 Wiring Diagram	5
4.4 Function keys in panel	5
5.0 Control Stick Adjustment	5
6.0 Neck Strap Usage	6
7.0 Stick Mode Switch	6
8.0 Switches between left-hand and right-hand throttles	7
8.1 Right-hand throttle switched to left-hand throttle	7
8.2 Left-hand throttle switched to right-hand throttle	8
9.0 Training function	8
10.0 Customized fixed ID	10
11.0 Installation requirement for receiver	11
12.0 Installation requirement for DEVO 7E battery pack	12
12.1 DEVO 7E Battery Charging	12

Part two: Helicopter

1.0 System Menu	14
1.1 Setup Language	14
1.2 Display	14
1.3 Buzzer Setup	15
1.4 Vibrator Setup	15
1.5 Stick Mode Setup	15
1.6 Stick Direction	16
1.7 Stick Calibration	16
1.8 About	16
2.0 Model Menu	16
2.1 Model Selection	16
2.2 Model Name	17
2.3 Model Copy	17
2.4 Model wireless copy	17
2.5 Model reset	18
2.6 Type Select	19
2.7 Trim System	19
2.8 Stick Position Switch	19
2.9 Device select	20
2.10 Device Output	20
2.11 Swash Type	21
2.12 Fixed ID	21
2.13 Sensor Setup	22
3.0 Function Menu	24
3.1 Reverse Switch	24
3.2 Travel Adjust	25
3.3 Sub Trim	25
3.4 Dual rate and Exponential	25
3.5 Throttle Hold	26
3.6 Throttle Curve	27
3.7 Mix to throttle	28
3.8 Gyro Sensor	29

3.9 Governor	30
3.10 Swash Mix	31
3.11 Pitch Curve	31
3.12 Program Mix	33
3.13 Monitor	36
3.14 Fail safe	36
3.15 Sensor View	36
3.16 Trainer	37
3.17 Timer	38

Part three: Airplane

1.0 System Menu	40
1.1 Setup Language	40
1.2 Display	40
1.3 Buzzer Setup	41
1.4 Vibrator Setup	41
1.5 Stick Mode Setup	41
1.6 Stick Direction	42
1.7 Stick Calibration	42
1.8 About	42
2.0 Model Menu	42
2.1 Model Selection	42
2.2 Model Name	43
2.3 Model Copy	43
2.4 Model wireless copy	43
2.5 Model reset	44
2.6 Type Select	45
2.7 Trim System	45
2.8 Stick Position Switch	45
2.9 Device select	46
2.10 Device Output	47
2.11 Wing Type	48
2.12 Fixed ID	49
2.13 Sensor Setup	50

3.0 Function Menu	52
3.1 Reverse Switch	52
3.2 Travel Adjust	53
3.3 Sub Trim	53
3.4 Dual rate and Exponential	53
3.5 Throttle Hold	54
3.6 Throttle Curve	55
3.7 Differential	56
3.8 Balance	58
3.9 Gyro sensor	59
3.10 Governor	60
3.11 Aileron to Rudder Mix	60
3.12 Elevator to flap mix	61
3.13 Rudder to aileron/elevator mix	62
3.14 Flap System	62
3.15 Aileron to flap mix	63
3.16 Program mix	64
3.17 Monitor	67
3.18 Fail safe	67
3.19 Sensor View	67
3.20 Trainer	68
3.21 Timer	69

4.0 Upgrading	70
----------------------	----

5.0 Hot keys usage	70
---------------------------	----

devention

DEVO 7E

Part one General information

DEVO 7E uses 2.4GHz Direct Sequence Spread Spectrum (DSSS) technology and features automatic ID binding, automatic ID assignment, and also features fixed ID set by yourself. The usage of wireless copy function keeps you away from the trouble in wire link-up. Two mode types of helicopter and airplane are available to meet your requirements for different models. Matrix LCD is used and it offers you convenient operation. Online update via USB ensures a transmitter in hand not to be out of date and makes it full of vigour.

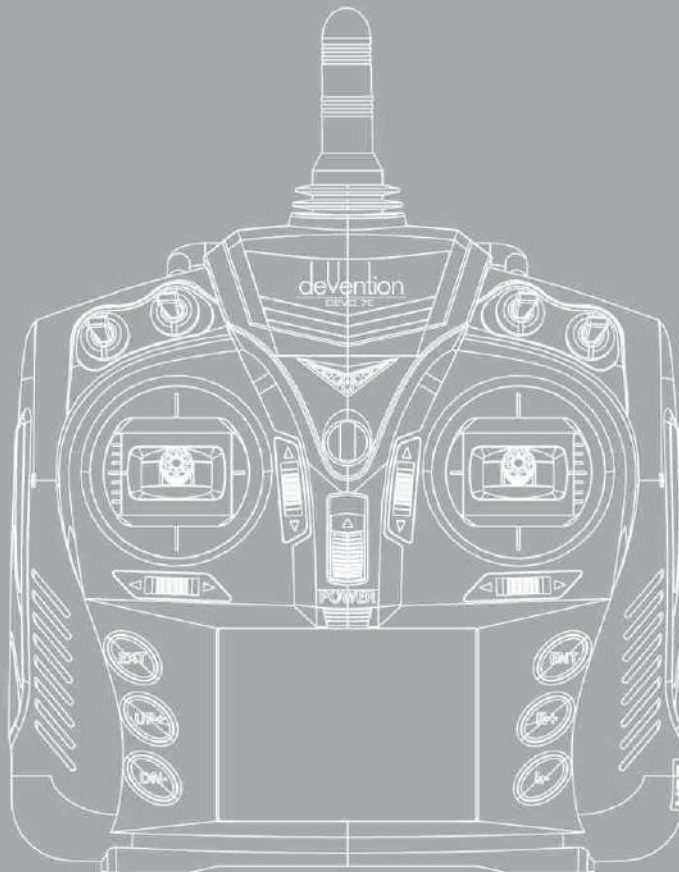

1.0 General information

1.1 Important statements

- (1) This transmitter is suitable for experienced pilots aged 14 years or more.
- (2) All model aircraft must be flown in an approved ground or location.
- (3) Walkera accepts no responsibility for damage or injury caused by mis-operation, mis-use or mis-control after purchase.
- (4) We consign our distributors to offer technical support and after-sales service. Please contact your local distributor for advice or troubleshooting on usage, setup, maintenance, etc.

1.2 Safety needing attention

- (1) Far away from people and obstacles.

An RC helicopter in flight has risk of uncertain flight speed and direction which is potentially dangerous. Please keep your radio controlled aircraft far away from people, high buildings, high-tension lines, etc, and avoid operating in rain, storms, thunder and lightning.



- (2) Keep away from humidity

Radio controlled aircraft should be kept away from humidity and vapor because its complex, precise electronic components and mechanical parts may be damaged.

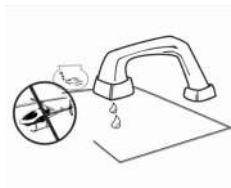

- (3) Proper operation and maintenance

Use original spare parts to upgrade, modify or maintain your equipment in order to ensure its safety. Please operate your equipment within the range of functions permitted. It is forbidden to use it outside of the safety laws.



- (4) Safe operation

Operate your equipment according to your physical status and flight skills. Fatigue, listlessness and misoperation will increase the possibilities of accidental hazard.



- (5) Protect from heat

The transmitter is composed of precise electronic components and mechanical parts. Keep it far away from heat sources and sunshine to avoid distortion, or even damage caused by high temperatures.



1.3 Attention before flight

- (1) Ensure the battery packs of both transmitter and receiver are fully charged.
- (2) Ensure both the throttle stick and the throttle trim of your DEVO 7E stay at the lowest positions before operation.

- (3) Strictly obey the order of TURN-ON and TURN-OFF before operation. When starting your flight, turn on your DEVO 7E first, and connect the battery to the aircraft last. When turning off the aircraft, disconnect the battery first, and turn off your DEVO 7E last. An incorrect order of connection or disconnection may cause the loss of control of your aircraft. Please cultivate the correct habit of turn-on and turn-off .
- (4) Ensure whether the directions and actions of all the servos in your RC aircraft are correct when executing commands of the transmitter. Never operate aircraft with a broken servo as it will result in further damage to the product or people.

2.0 Features

2.1 Transmitter DEVO 7E

- (1) The DEVO 7E uses 2.4 GHz Direct Sequence Spread Spectrum (DSSS) technology and supports both fixed and automatic ID binding and ID assignment.
- (2) USB Online firmware updates permit use of the latest transmitter features.
- (3) Adjustable radio power output to improve battery life.
- (4) Wireless data transmission between two DEVO 7E simplifies the use of training mode.
- (5) 30-model memory data slots available.
- (6) DEVO 7E adjusting the gyro sensitivity makes hovering flight and fancy flight in an easy way. AUX2 Gyro variable gain control makes adjustment for hovering or 3D flight simple.
- (7) Ergonomic design provides comfortable and straight forward operation.
- (8) DEVO 7E supports software switching between control Modes 1, 2, 3 and 4.
- (9) DEVO 7E is suitable for both helicopter and airplane control. In helicopter mode, three flight modes are available,each one can be individually set and parameters can be configured to support normal, F3C or 3D aerobatic flight modes as required.

2.2 DEVO-RX701 Features

- (1) Uses 2.4GHz Direct Sequence Spread Spectrum (DSSS) which features instantaneous reaction and strong anti-jamming protection.
- (2) Twin receiving circuits and automatic signal switch automatically effectively ensure the stability of receiving signal.
- (3) Single chip Microco CPU provides super-strong signal analysis and filtering.
- (4) Frequency and ID memory maintained by the receiver to simplify and speed up switching battery packs with transmitter powered on.
- (5) Supports setting of Fixed ID or Automatic ID assignment as desired.

3.0 Specification

3.1 DEVO 7E transmitter Specification

- Encoder 7-channel micro computer system
- Frequency 2.4GHz DSSS
- Output power..... ≤ 100 mW
- Current drain ≤ 200 mA (100 mW)
- Power supply..... 5# Battery 4 X1.5V or NiMH 4 X1.2V 1,600 - 2,000 mAh
- Output pulse1000 – 2000 Ms (1500Ms Neutral)

3.2 Receiver specification

- Type 2.4GHz 7 channels
- Sensitivity..... - 105 dbm
- Frequency interval ≥ 4 M
- Weight 11.6 g
- Dimension 43X28X16mm
- Receiver Battery 4.8-6V 1,300mAh

4.0 Definition of DEVO 7E

4.1 Front Panel view



4.2 Rear view



(1) Charge socket (CHG): input DC at 8-12V, 200 mA; Polarity: $\oplus \rightarrow \ominus$

(2) Digital Signal Converter socket (DSC): used for computer based simulator flight practice (requires additional software and connector dongle available from hobby shops), also can be used for wired training mode.

(3) MINI USB Socket: Used for upgrade the transmitter firmware when the USB combined the PC machine and the transmitter USB socket.

4.3 Wiring Diagram

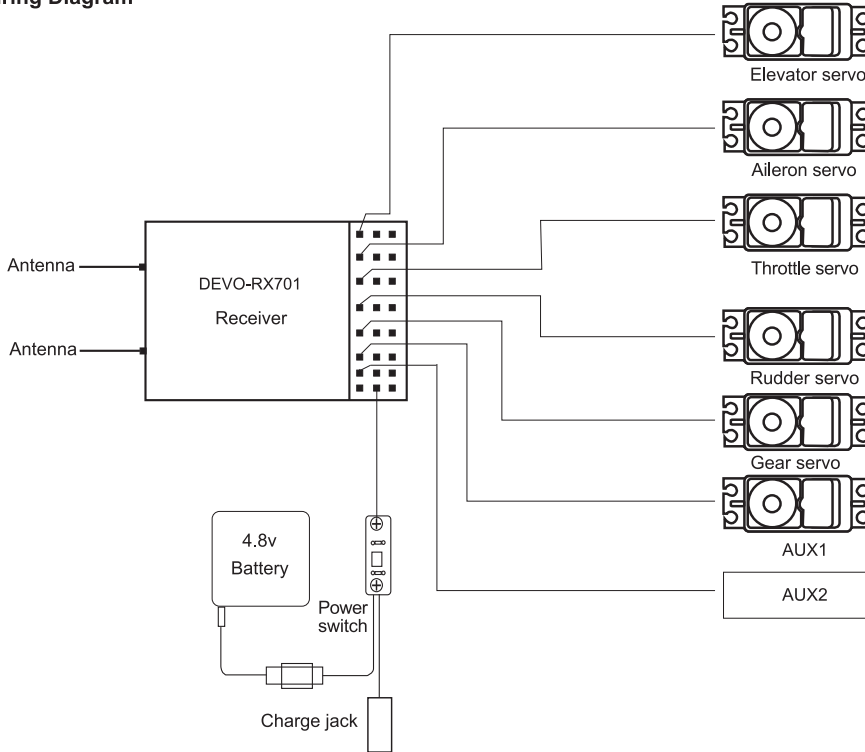

4.4 Function keys in panel

There are 6 function keys in the panel of DEVO 7E. Below are the details:

- (1) EXT: Reset key. Press EXT to exit the main menu.
- (2) ENT: Confirmation key. Press ENT to access the system or the function mode.
- (3) UP+: Moves cursor up to the previous function item.
- (4) DN-: Moves cursor down to the next function item.
- (5) R+: Moves cursor right to increase the setting value.
- (6) L-: Moves cursor left to decrease the setting value.

5.0 Control Stick Adjustment

The stick adjustment : tension only, here is the steps:

- 1 Remove the left lateral , right lateral left and right non-slipping blocks, respectively.
- 2 Use a screw driver to loosen the fixed screws A, B, C, D, and E, and then remove the base plate.

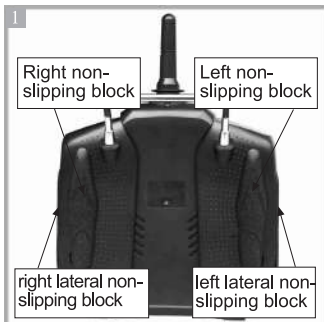

Find the tension adjuster spring for left and right hand throttle stick as shown below. Using a cross head screwdriver adjust the screw ringed in red below; clockwise will increase stick tension and counter-clockwise reduce it. Replace the transmitter rear cover after completion.

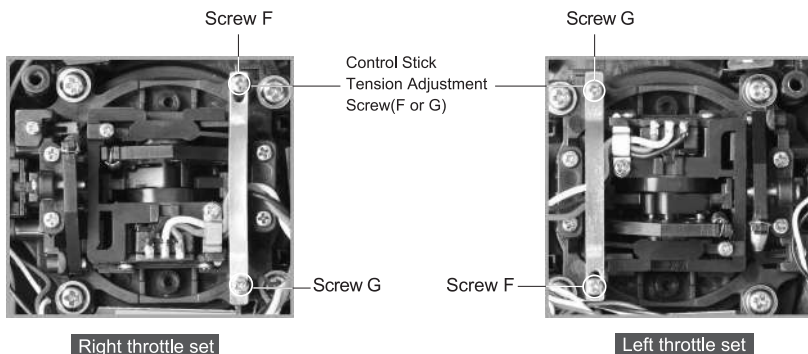

6.0 Neck Strap Usage

There is a concealed hook in the face panel of DEVO 7E. It will pop up as you press the hook. The neck strap can be connected to the hook. The hook located at the center helps to get optimal balance of the transmitter.

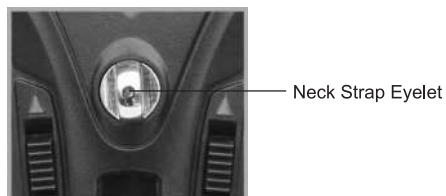

7.0 Stick Mode Switch

There are total four stick modes from MODE 1 through MODE 4. The left-hand throttle includes MODE 2 and MODE 4, and the right-hand throttle includes MODE 1 and MODE 3. Each Mode's configuration diagram is below:

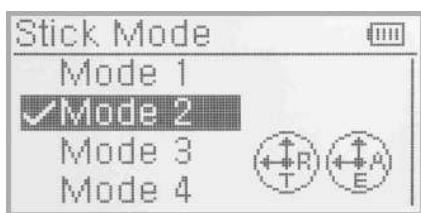

MODE 2

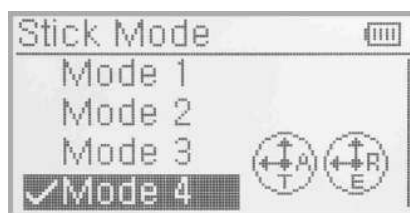

MODE 4

MODE 2 and MODE 4 are configured for left-hand throttle.

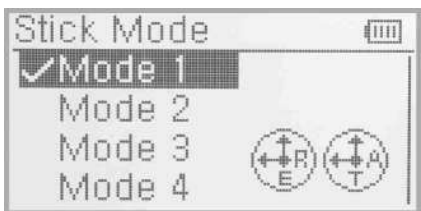

MODE 1

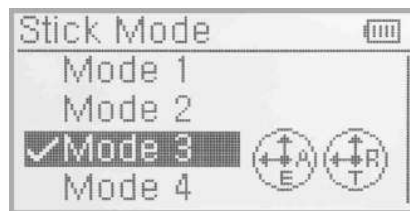

MODE 3

MODE 1 and MODE 3 are configured for right-hand throttle.

8.0 Switching between left-hand and right-hand throttles

Switching between left and right-handed throttle modes requires both a MECHANICAL and ELCTRONIC switch. It will work correctly only after both parts are completed. Please follow the steps below :

8.1 Right-hand throttle switched to left-hand throttle

(1) MECHANICAL step

- 1 Remove the left lateral and right lateral non-slipping blocks and the left and right non-slipping blocks on the base plate, respectively.
- 2 Remove the fixed screws A, B, C, D, and E, and then remove the base plate.

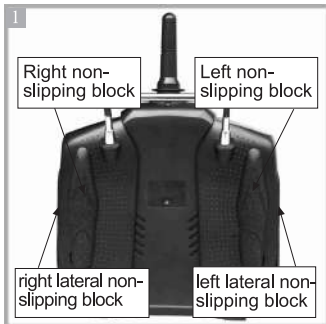

Remove the 6 screws and rear cover to expose the base plate. The photo below shows the internal views of right and left hand throttle setups. Using a cross-head screwdriver loosen and remove, in order, the Linkage Fixed Screw, Screw F, Screw G and the Throttle Control Spring from the right throttle set, remount the parts removed into the left throttle set in the corresponding (rotated) positions shown below. Adjust the tension using Screw F to match your preferred setting. Replace the rear cover.

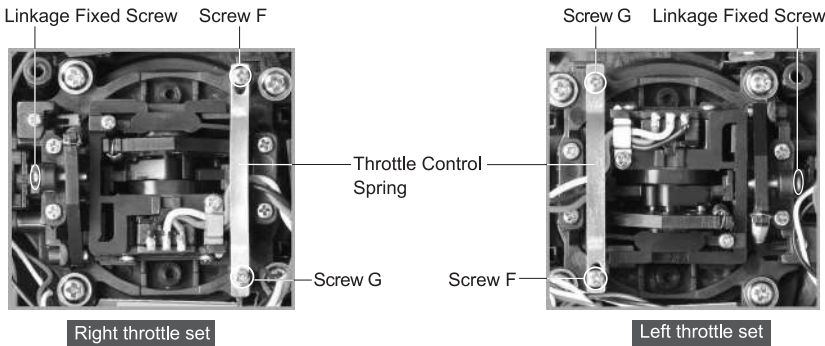

(2) The ELECTRONIC Step

From the Main Front Panel, press "ENT" button, in the LCD screen, "System" will start to flash. Press the "ENT" button again to enter the System Menu. Use the UP and DN buttons until flashing "STMOD" appears, press "ENT" to enter Stick Mode Selection Menu. Use UP or DN buttons until flashing "MODE 2" or "MODE 4" appears. Press "ENT" to confirm and "EXT" button to return to operation mode.

All saved model data will automatically be switched to be compatible with Mode 2 or Mode 4.

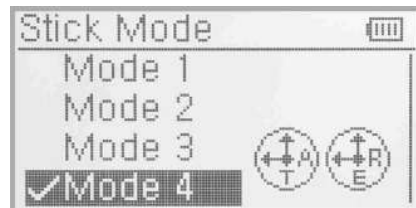
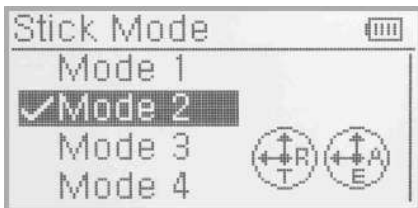

Once both the MECHANICAL and ELECTRONIC steps are successfully completed the transmitter is now ready for normal operation.

8.2 Left-hand throttle switched to right-hand throttle

(1) Mechanical Step

Refer to the above(8.1) "Mechanical switch" to remove the transmitter cover.

Remove the 6 screws and rear cover to expose the base plate. The photo below shows the internal views of right and left hand throttle setups. Using a cross-head screwdriver loosen and remove, in order, the Linkage Fixed Screw, Screw F, Screw G and the Throttle Control Spring from the right throttle set, remount the parts removed into the left throttle set in the corresponding (rotated) positions shown below. Adjust the tension using Screw F to match your preferred setting. Replace the rear cover.

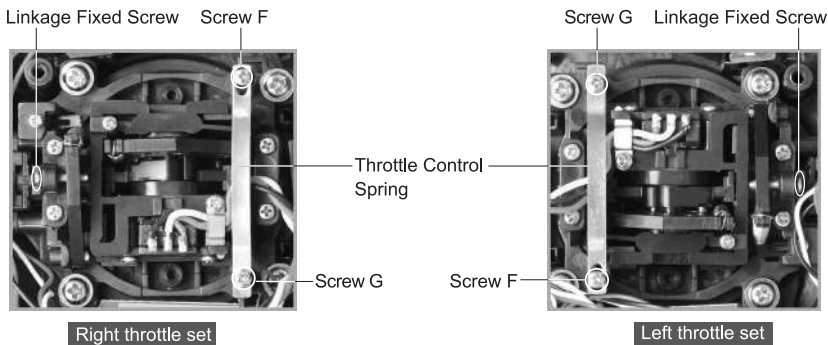

(2) The ELECTRONIC Step

From the Main Front Panel, press "ENT" button, in the LCD screen, "System" will start to flash. Press the "ENT" button again to enter the System Menu. Use the UP and DN buttons until flashing "STMOD" appears, press "ENT" to enter Stick Mode Selection Menu. Use UP or DN buttons until flashing "MODE 1" or "MODE 3" appears. Press "ENT" to confirm and "EXT" button to return to operation mode.

All saved model data will automatically be switched to be compatible with MODE 1 or MODE 3.

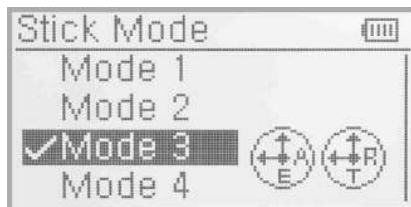
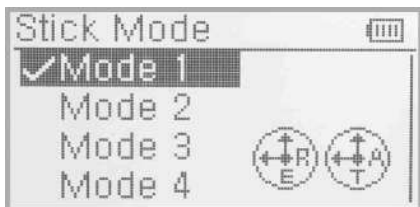

Once both the MECHANICAL and ELECTRONIC steps are successfully completed the transmitter is now ready for normal operation.

Note: Pay careful attention to the force used when removing, replacing and adjusting the screws. Excessive force may damage them or the base plate.

9.0 Training function

Two DEVO 7E transmitters can be made to work together in order to offer a teacher/trainer function, meeting the requirements for a beginner. The setup of training mode is described below :

(1) Model data transmission

First step is to use the DEVO 7E's wireless data transmission feature to transfer the teacher's main model data to the trainee's DEVO 7E transmitter. This step guarantees that the model data in each transmitter is identical. Refer to item "2.4 model wireless copy" in the Helicopter section later in this manual. Two DEVO 7E transmitters are needed for wireless data transmission.

(2) Training connection

Insert one end of the signal wire (included) into the DSC socket of the trainee's transmitter and turn it on. PC 0% will be shown in the trainee's DEVO 7E display (see image right).



linkage icon

Turn on the power of the trainer's DEVO 7E. Select the same model as the trainee (as transferred in the previous section) and briefly fly the aircraft to confirm the settings are good. Turn off the aircraft and turn off the trainer's DEVO 7E power. Insert the other end of the signal wire into the trainer's DEVO 7E DSC port and turn on the power once more.



Trainer icon

Training status display: when the trainer's icon becomes into "X", the trainee stops flying and the trainer is working; when the trainer's icon turns into "✓", the trainee is flying and the trainer is in leisure.

(3) Usage method

The default setting of the training switch is "R+" key. During flight, if the trainer press "R+"key, the linkage icon will be shown as "✓" that means the control right is moved to the trainee from trainer. If trainer pushes "R+" key once again, the linkage icon will be show as "X" that means the trainer takes back the control right from the trainee.



(4) Setting for training function channels

Trainee is available to get full or part of flight control power to the aircraft model via setting the training function channel in the trainer's radio. Below is the setting method:

Press the ENT key to enter Main Menu, and then press UP or DN to get access to function menu. Then press UP or DN to select "training function" and press ENT key to enter Trainer interface. The available channels are shown below, and the current status of trainer switch is also shown there. Available channels include: Elevator, Aileron, Throttle, Rudder, Gear, Pitch and Gyro.

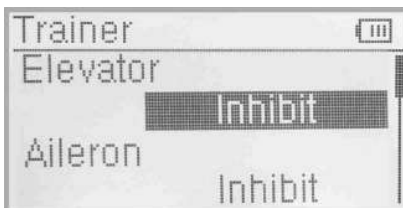

Channel selection:

Press UP or DN to select the channel option; press R or L to select the channel(s) which you want to grant to trainee. The channel(s) you have selected will be activated as "Active". The channel(s) which are not granted to trainee will be kept inhibited. The default setting is "Inhibit".

Press EXT to exit.

10.0 Customized fixed ID

Using the Fixed ID function allows users to create a unique relationship between transmitter model data and the corresponding model's receiver. It significantly speeds up the binding process and also prevents mistakenly flying an aircraft with the incorrect transmitter model selected.

(1) Fixed ID setup

To start the Fixed ID setup it is important that the transmitter and receiver have successfully completed automatic ID binding process. Once the transmitter and receiver are paired a Fixed ID can be set as described below.

Press the "ENT" button on the main panel and a flashing System will display in the LCD. Use UP or DN to cycle through the options until Model menu appears flashing. Press "ENT" again to enter into Model edit menu. Press UP or DN until a flashing "FIXID" is displayed, press "ENT" to enter the Fixed ID menu. The current status is displayed. Use R or L to toggle between modes and set to "ON". Press DN to confirm and enter the Fixed ID code setting screen.

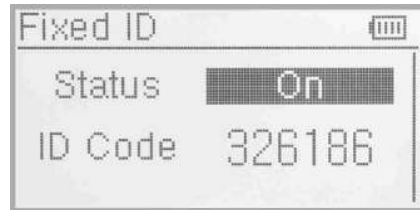
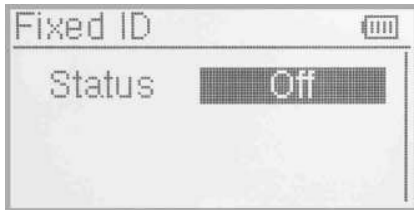

Press ENT to change the code data, use R and L to change the code values, press DN to move to the next digit, UP to move to the previous digit. There are 6digits can be settled.



After setting the desired code press ENT, "RUN" will be displayed. Use R or L to change NO to YES and press ENT to confirm and execute the binding process. An inquiry interface of "Are you sure?" pop up. "ID Code Matching" will be shown after press ENT. After binding the display will return to the model menu automatically.

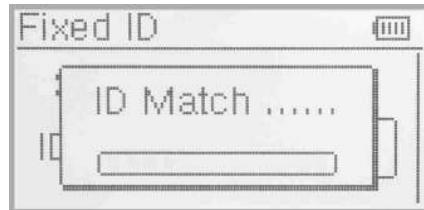
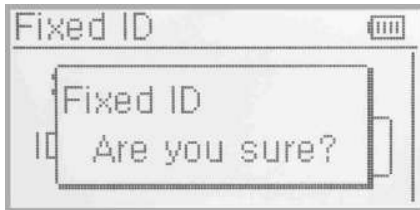

(2) Cancelling/Resetting the Fixed ID

If you wish to change the receiver Fixed ID model back to random ID, insert the included BIND PLUG into the output terminal BATT before the receiver is powered on. Connect 5V DC power to the Throttle channel. The red LED of the receiver will flash slowly. Remove the BIND PLUG. The Fixed ID code has been cancelled. After the receiver's Fixed ID is reset it should also be reset in the Transmitter. Here is the setup:

In the main interface press the ENT to enter Model Menu and then press UP or DN to move the navigational mark to select MODEL MENU. Press ENT to enter MODEL MENU. Press UP or DN to select Fixed ID code and press ENT key to enter the Fixed ID code interface. Press UP or DN to select STATUS option, Press R or L to change the status to Off. Then press EXT to exit.



11.0 Installation requirement for receiver

Below is some advice on how to install your equipment.

- (1) Using 10mm thick foam, wrap the receiver and attach it securely to the aircraft using a cable tie or strong rubber band. The foam will help protect the receiver.
- (2) It is suggested to use rubber grommets and copper washers to isolate the receiver from vibrations. Do not over tighten the screws in order that the grommets are not damaged otherwise vibration absorption will be reduced.
- (3) When mounting the servos, make sure the servos' bellcranks can move freely over their whole travel range and ensure the control linkages don't touch or impede the movement of the servos.
- (4) If installing additional switches, please install them far away from the engine exhaust pipe and other high vibration sources. Ensure all the switches move freely over their entire range.
- (5) Don't wrap the receiver antennas together or make them parallel; horizontal at 90° will give the best performance.



12.0 Installation requirement for DEVO 7E battery pack

Open the battery cover of DEVO 7E transmitter and take out the battery box. Insert 4 new cells AA batteries either Alkaline or full charged NIMH battery into the battery box. Please double check the polarities are correct and do not mix old and new batteries.

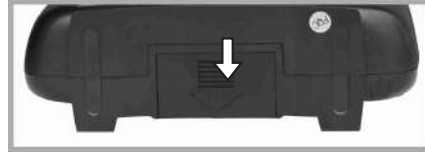

WARNING:

- (1) Inserting the batteries with the incorrect polarity can cause damage to the transmitter and/or batteries.
- (2) Do not put the polarities of batteries in the opposite directions.
- (3) Fool-proofing must insert correspondingly when battery pack connect to radio, see below:

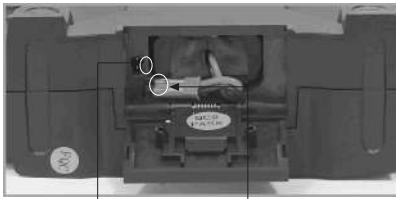

Power fool-proof plug Battery box fool-proof plug

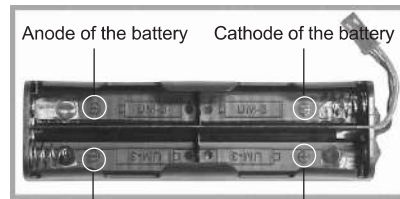

Anode of the battery Cathode of the battery
Cathode of the battery Anode of the battery

12.1 DEVO 7E Battery Charging

WARNING: The CHG socket is only suitable for use with NiMH batteries. If using alkaline batteries or a LiPO pack, it is forbidden and dangerous to use the CHG socket.



Charge socket(CHG):input DC at 8-12V,200mA; Polarity: ⊕ → ⊖

Part two Helicopter

All the functional settings, which are relative to the operation system of DEVO 7E itself, are fully integrated in System Menu. They include Language, Display, Buzzer, vibrator, Stick Mode, Stick Direction, Stick calibration, and About. Setup your DEVO 7E transmitter for the best Helicopter performance with the following sections. Included are specific functions for rotor-craft features; Throttle curves, Pitch curves and Cyclic response are covered below.

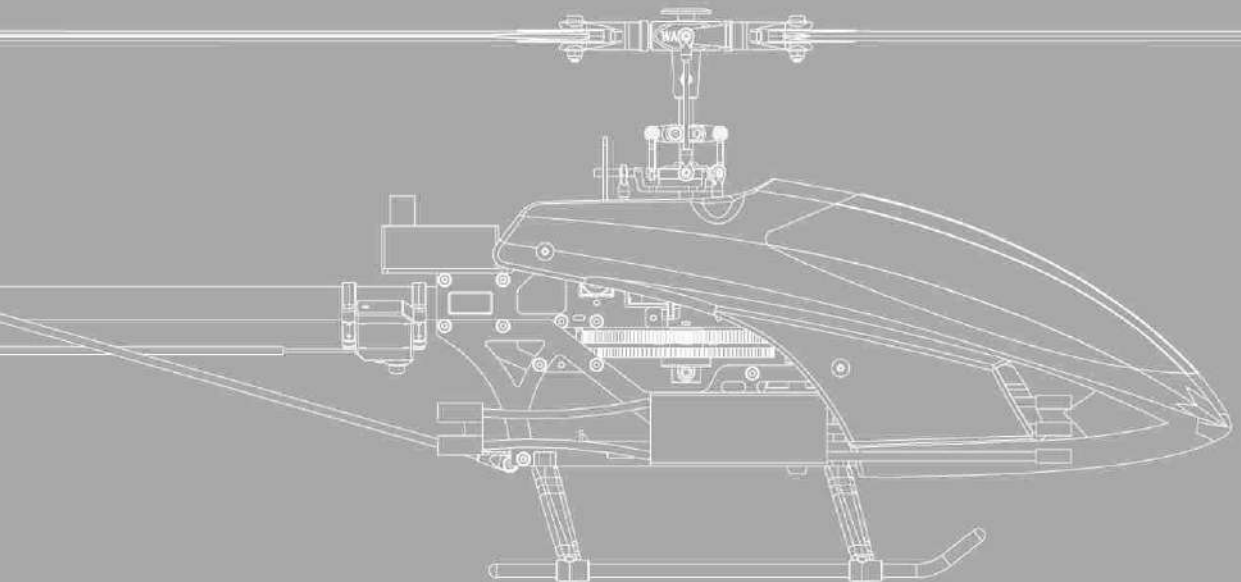

1.0 System Menu

This section describes the settings which are specific to the operation of the DEVO 7E itself. Settings for Language, Display, Buzzer, vibrator, Stick Mode, Stick Direction, Stick Calibration and About (Firmware) can all be accessed via the System menu.

Below is the boot screen of helicopter:

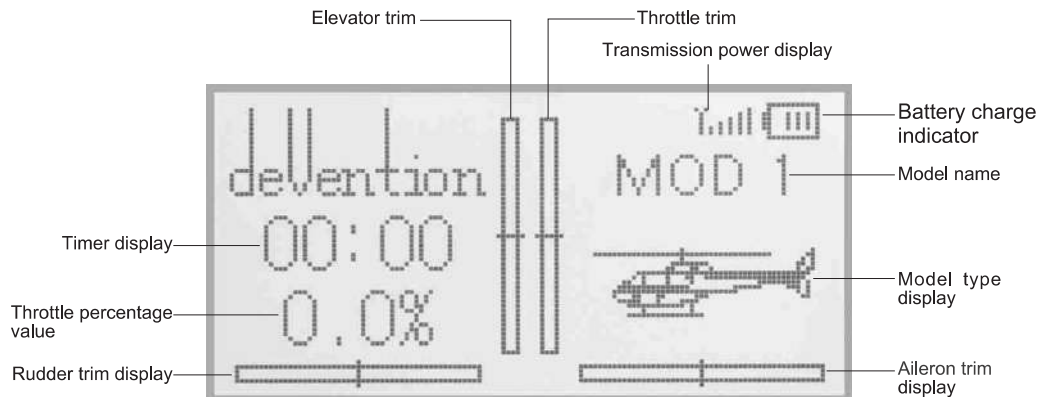

1.1 Setup Language

Choose the native language for the DEVO 7E. Here is the setup: Press ENT to enter System Menu and then press UP or DN to move the navigational mark to select System menu. Then push ENT to enter System menu. Press UP or DN to select Language and press ENT to enter the language interface. Press UP or DN to select the language that you desire. A "✓" will be shown on the screen after selected. Push EXT to exit.

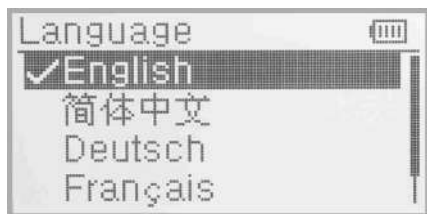

1.1 Language setup

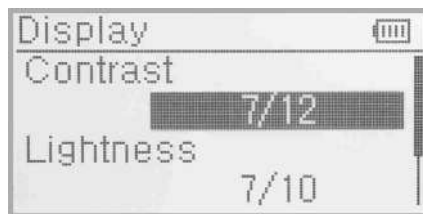

1.2 Display

1.2 Display

Three items are available to be set for Display:

- (1) Backlight contrast: the backlight contrast is adjustable by using UP or DN buttons to move the navigational mark to the digits after Contrast. Press R key to increase the backlight contrast, while press L to decrease it.
- (2) Backlight intensity: the backlight intensity is adjustable using the up or DN buttons. Power consumption will be increased when intensity is high and battery life will be reduced. When the value is one means turn off the backlight.
- (3) Backlight timeout: the duration for which the LCD stays lit can be configured from 5 to 60 seconds in 5 second intervals or set to "Always On".

Below are the setup:

Press ENT to enter the main menu, use UP or DN to move the navigational mark to select system menu. Press ENT to enter the System sub-menu, use UP or DN to select Display to enter "DISPL" interface. Press DN to enter the Backlight time-out setting, use R or L to adjust the period up to 60 seconds, using a setting of 0 means always on. Press ENT to confirm and EXT to exit to main menu.

Press EXT to exit.

1.3 Buzzer Setup

Pressing ENT to enter the main menu, use UP or DN to select system menu, press ENT to enter System menu. Use UP or DN to select Buzzer, press ENT to enter the buzzer interface.

- (1) [SYSTEM/BUZZE/STATE] Buzzer ON/OFF: Press ENT button to enter the main menu, press ENT again while "SYSTEM" is flashing. Use UP and DN until flashing "BUZZE" is displayed and press ENT. When "STATE" is shown, press R or L to toggle between ON and OFF settings. Press ENT to confirm and EXT to exit.

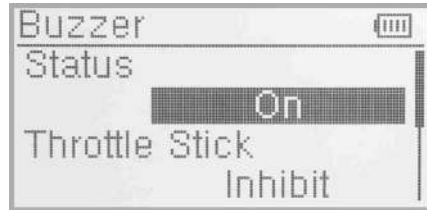

- (2) [SYSTEM/BUZZE/THSTK] Throttle stick: under the Buzzer setting menu the option THSTK can be set to ON or OFF. If the Throttle Stick setting is ON/Active, a musical scale will be heard when moving the throttle stick. The position of the throttle stick can be judged by listening to the change in musical tone. Setting OFF, turns off the sounds. After setting the [BUZZE\STATE] setting, press DN until THSTK is displayed. The current status is displayed, press R or L to change the display between INH and ACT. ACT means tones will be played, INH means there will be no tones played.

- (3) [SYSTEM/BUZZE/TONE] Buzzer tone: the buzzer tone can be selected from 10 notes. You can set the tone according to your preference. After setting the "THSTK", press DN until "TONE" is displayed. Use R or L key to change the flashing value between 1 and 10. Press EXT button to exit when finished.

1.4 Vibrator Setup

The DEVO 7E can set Vibrator as an alarm function.

Setup: Press ENT to the Main Menu, use UP or DN to select System Menu. And then press ENT to get the System Menu, use UP or DN to select Vibrator. Press ENT to get Vibrator setup interface. There are Inhibit and Active two status. Press R or L to select Active for Vibrator function. Press EXT to exit after finished.

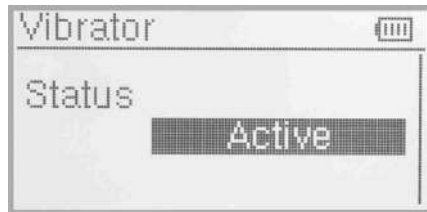
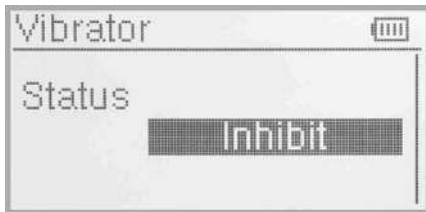

1.5 Stick Mode Setup

There are 4 stick modes including MODE1, MODE2, MODE3 and MODE4. Right-hand throttle includes MODE1 and MODE3; while left-hand throttle includes MODE2 and MODE4. See below setup:

[SYSTEM/STMOD] Stick Mode: from the SYSTEM menu, press UP or DN until flashing "STMOD" is displayed, press ENT again to enter the stick mode selection sub-menu. Use R or L to select the required stick mode. Press ENT to confirm the flashing value and EXT to exit to the main menu.

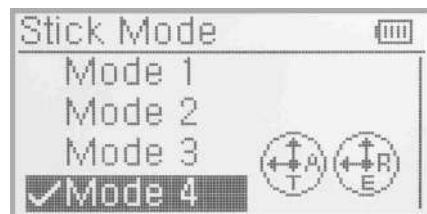
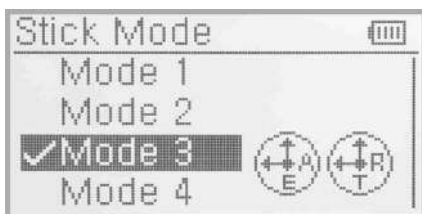
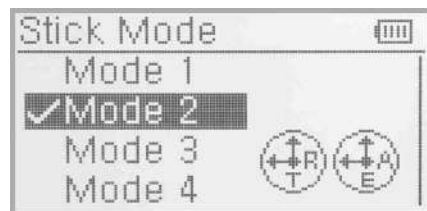

Please refer to 8.0 Switches exchange between left-hand and right-hand throttles. Press EXT to exit after finished.

1.6 Stick Direction

Press ENT to enter into Main Menu; Press UP or DN to make navigation mark at System menu. Press ENT to enter into System menu; Press UP or DN to choose Stick direction, press ENT to enter into Stick direction interface.

Stick Direction: There are four items available as Elevator, Aileron, Throttle and Rudder. Press UP or DN to select the stick which will change direction, and press R or L to change the direction. The factory setting is Normal.

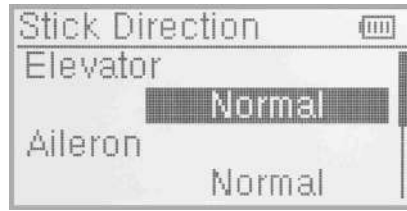

1.7 Stick Calibration

The stick calibration is used to re-calibration when stick unusual.

Enter the System Menu, use UP or DN to select Stick Calibration and press ENT to the Stick Calibration setup interface. Press ENT to enter Calibration, the display will be as shown below:

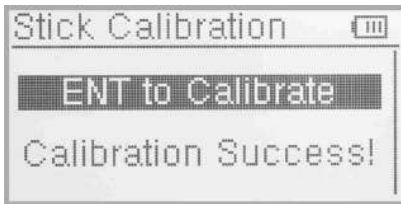
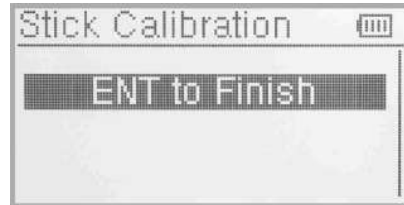
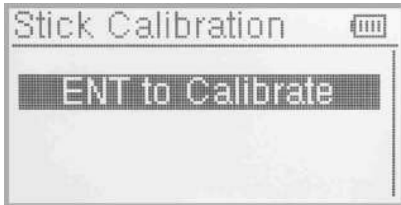

Stick calibration: Move all of the control sticks to their maximum and minimum levels several times, when complete, return the sticks to their neutral positions.

Press ENT again to STOP the calibration process and the display should show "START: SUCCESS".

If the display shows "STOP:ERROR", the calibration has failed. Please go back to the STMOD sub-menu using EXT and re-start the calibration process.

Press EXT to exit after finished.

1.8 About

From the SYSTEM menu, use UP or DN to choose About and press ENT to enter About interface. The firmware and Library version will be displayed.

Press EXT to exit when finished.

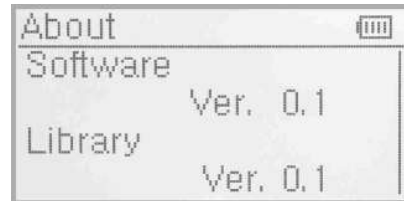

2.0 Model Menu

Model Menu manages all the model data saved in DEVO 7E. It includes Model Select, Model Name, Model Copy, Model Transmit, Model Receive, Model Reset, Type Select, Trim System, Stick Position Switch, Device Select, Device Output, Swash Type, Fixed ID and Sensor setting.

2.1 Model Selection

Press ENT to get Main Menu and press UP or DN to select Model Menu. Press ENT to get the Model Menu and press UP or DN to select Model select, press ENT to get the Model Select setup interface.

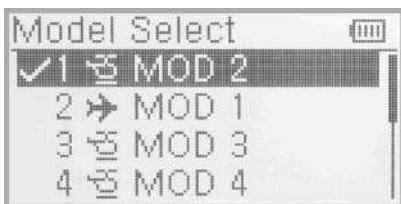

Press UP or DN until the desired model starts to flash. A total of 30 model configurations can be stored. Press ENT to confirm then EXT to exit

2.2 Model Name

In the model name menu, you can edit the model name to 8 characters of your own choosing to simplify configuration selection next flight session. First, follow step "2.1 Model Selection" to choose the model you want to rename or edit.

Press ENT to enter the Main Menu, use UP and DN to select MODEL, press ENT to enter Model sub-menu, press UP or DN until "NAME" is in the display. Press ENT again to display the serial No. (1~30) and current name. Use UP and DN to select the characters to be changed, use R or L to change the selected character.



Press ENT then EXT to finish.

2.3 Model Copy

Press ENT to enter the Main Menu, use UP and DN to select MODEL Menu, press ENT to enter Model submenu, press UP or DN until " Model COPY" is in the display. Press ENT again to select the source Model. Use R and L to change the selected model.

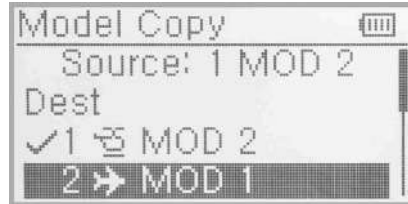
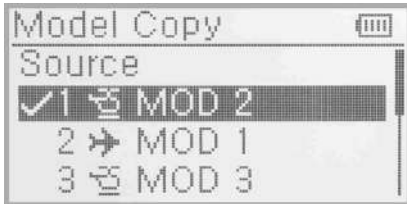

Press ENT to confirm the destination model into which to copy the current settings. " Are you sure?" will be displayed as below Illustration, Press ENT to confirm the copy or EXT to exit.

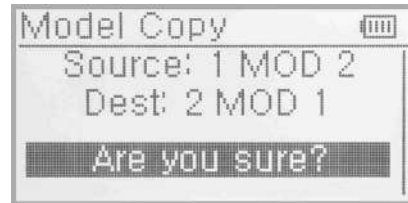

2.4 Model wireless copy

Model data can be copied wirelessly between two DEVO 7E units using the Model Transmit and Model Receive functions in the Model menu.

(1) Model Data transmission

Press ENT to enter the Main Menu, use UP and DN to select Model Menu, press ENT to enter Model sub-menu, press UP or DN until " Model Transmit " is in the display. Press ENT again and use R and L to choose the source model which will be transmitted.

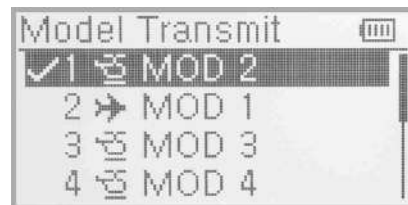

Press ENT again to confirm, an enquiry "Are you sure?" will be shown as below Illustration, Press ENT to transmit, "Transmitting" appears in the interface. Or press EXT to exit. Press EXT to exit after another DEVO 7E received the data.



(2) Model Receive

To receive model data, first select the model into which data should be copied, follow the process of model selection described previously. Model receive can overwrite an existing configuration so be sure to select carefully. Press ENT to enter the Main Menu, use UP and DN to select Model Menu, press ENT to enter Model submenu, press UP or DN until Model Receiving is in the display. Press ENT again to confirm. An enquiry information "Are you sure?" will be shown as below illustration, press ENT to confirm the reception, press EXT to exit.

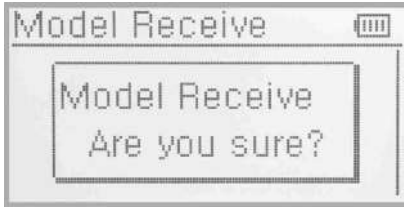

After pressing ENT to receive, the display shows "Connecting" in the interface. The information of "Received" with the model name will be shown after receiving is finished. Or press EXT to exit.

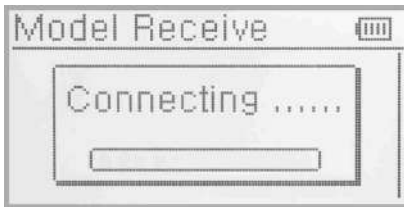

Press UP or DN to choose the save position, an enquiry information "Are you sure?" is shown after press ENT. Press ENT to save or press EXT to exit.

After saving is complete the system will return to the main menu.

Press EXT to exit after finished.



2.5 Model reset

Using the Model Reset function the settings for one or all models can be reset to the factory defaults.

It is possible to store up to 30 models data in the model list of DEVO 7E equipment. There are two methods to reset the model data: batch reset and single reset. Here is the setup:

Press ENT to enter the Main Menu, use UP and DN to select MODEL, press ENT to enter Model sub-menu, press UP or DN until "Model Reset" is in the display. Press ENT to get Model reset setting interface. Use R and L to select "ALL" for all models or the individual model name for a single model reset.



After selecting ALL or a specific model, press ENT, "Are you sure?" enquiry is displayed, press ENT to confirm or EXT to cancel.

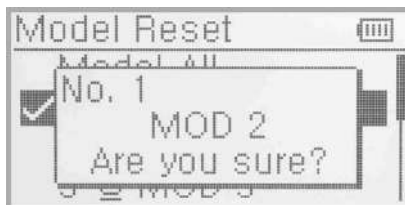
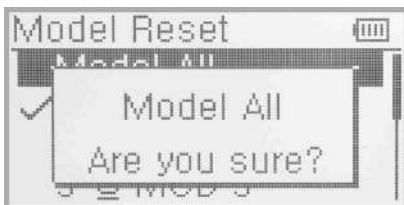

Press EXT to exit after finished.

2.6 Type Select

This transmitter offers a choice of two model types. The options are helicopter and airplane.

Press ENT to Main Menu, press UP or DN to select Model Menu. Press ENT to enter and press UP or DN to select Type Select and press ENT to enter Type select interface. Use UP or DN to select Helicopter or Airplane, press ENT to confirm, then press EXT to exit.

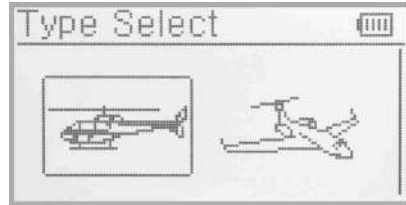

2.7 Trim System

The Trim System permits the user to fine tune the following items: Elevator, Aileron, Rudder, Throttle. The trim step is divided in to 20 (factory default is 4). Using small values, permits fine trim control, larger values make larger adjustments for each 'click' of trim. the procedure to adjust the trim step is as follows:

Press ENT to get Main Menu and press UP or DN to select Model Menu. Press ENT to enter and press UP or DN to select Trim System, press ENT to enter setting interface. Use UP or DN to select Elevator,Aileron,Rudder and Throttle. Use R or L to change the step value.Press ENT to confirm and EXT to exit.

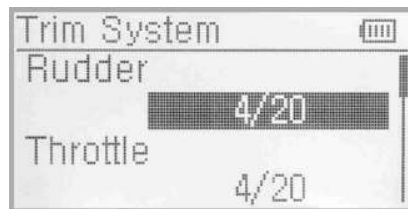
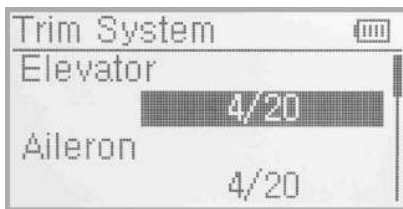

Press UP or DN to select the trim which will set, press R to increase the trim value and press L to decrease. For elevator, aileron and rudder, there are two more options : Normal and Limited. Press R or L you can change the setup. " Normal: means the trim is always working although th corresponding stick stays anywhere. "Limited" means the trim is out of working when the corresponding stick is at maximum position.

The last 3 settings in this menu determine if the trim is applied at full control stick or not. This can prevent servo binding at maximum extents. When "NORM" is displayed, the trim setting is always applied, even at 100% travel. "LIMIT" setting, means that the trim is not applied when the control stick is a full travel. Default is "NORM". Press ENT to confirm, EXT to exit.

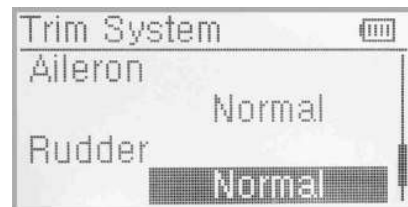
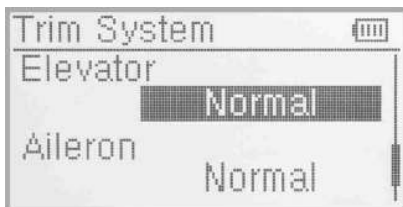

Press EXT to exit after finished.

2.8 Stick Position Switch

According to the following setting, the switch can be used as a switch. The turn-on or turn-off position at which stick stays can also be settable.

Setup:

Press the ENT to get Main Menu and press UP or DN to select Model Menu. Press ENT to get Model Menu and press UP or DN to select Stick Position Switch, press ENT to get Stick Position Switch setting interface.

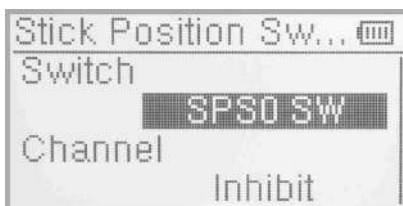

There are four options under the Stick position switch: SPS0, SPS1, SPS2, SPS3. Press R or L to choose the switch you want to define.

Press UP or DN to inhibit channel in navigation mark, and press R to expand the menu. The channel includes four items: Elevator, Aileron, Throttle and Rudder. The factory default is Inhibit. Take Elevator for example.

Press R or L to choose the Elevator as stick, then Press DN to move navigation mark to value of position. It's possible to adjust the stick position via pressing R or L.

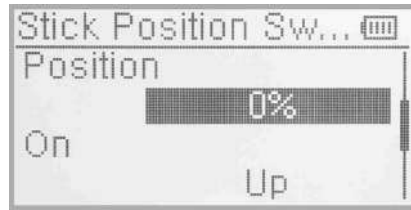

Press DN to navigate the OPEN setting, press R or L to change the direction of the channel stick.

Press UP or DN to navigate the STATUS, which can check the sketch map of the stick OPEN/CLOSE direction. Check if it was set correctly.

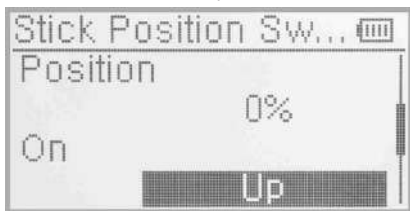

After finished the setting, press EXT to exit.

2.9 Device select

This setting allows customization of the various function switches. The switches Flight Mode (top right corner) and Throttle Hold (top left corner) can accept custom settings. Stunt Trim mode can also be defined under this sub-menu. Setup:

Press ENT to enter Main Menu, press UP or DN to move navigation mark to select Model menu. Press ENT to enter Model menu function. Press UP or DN to select Device Option. Press ENT to Device Option interface.

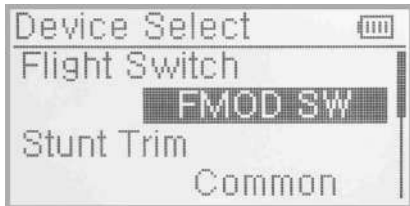

- (1) Flight Mode Switch: Press UP or DN to move navigation mark to Flight Switch and press R or L to select the desired switch, there are both FMOD SW and HOLD SW, . The factory default setting is FMOD switch.
- (2) Stunt Trim Mode: There are two option modes, Common and Flight Mode. In Common Mode, all the trim values settings are applied the same to each Flight Mode. In Flight Mode, the trim value can be set and remembered

differently for each of the 3 available Flight Modes. The default is common.

Setup:

Press UP or DN to choose the Stunt trim select, press R or L to select "Common" or Flight Mode, the factory default setting is Common.

(3) Throttle Hold Switch: Refer to "(1) Flight Mode switch"

After finishing the setting, press EXT to exit.

2.10 Device Output

Device output can set up the output switches respectively. It can also activate, inhibit or use other functions.

Setup:

Press ENT to enter main menu, press UP or DN to move navigation mark to Model Menu. Press ENT to enter Model Menu. Press UP or DN to select Output Device and press ENT to enter Output Device interface.

There are 2 settings: Gear, AUX2.

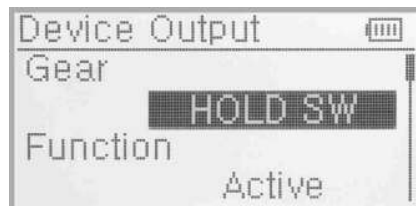

(1) Gear

Press UP or DN in output interface can change the GEAR Switch. It includes FMOD SW, HOLD SW, SPS0 SW, SPS1 SW, SPS2 SW, SPS3 SW. Press R or L to select the setting switch, The default setting is HOLD SW.

Press UP or DN to select Function Setting after you select the switch, Press R or L can enter the interface of Gear activate, inhibit, Gyro and Governor. The default setting is Activate. You can continue to set other items after finishing.

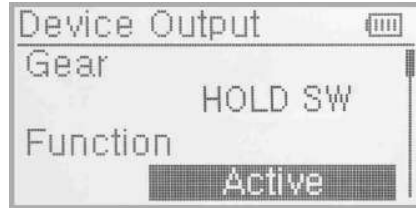

(2) AUX 2

Press UP or DN to enter the AUX2 interface. Press R or L can change the AUX2 switch. It includes FMOD SW, HOLD SW, SPS0 SW, SPS1 SW, SPS2 SW, SPS3 SW. The default setting is FMOD switch.

Press UP or DN to select the Function Setting, press R or L to choose the switch, it includes Inhibit, Active, Gyro, Governor. The default setting is Gyro.

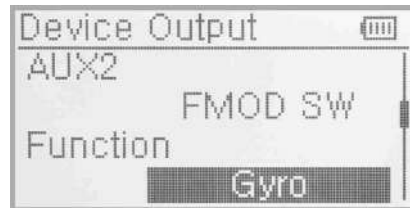
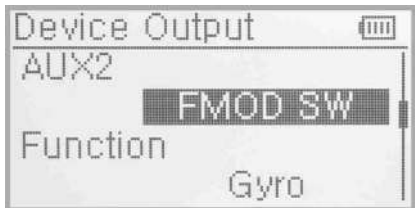

After finishing the setting, press EXT to exit.

2.11 Swash Type

The Swash Type menu features five options: 1 Servo Normal, 2 Servos 180°, 3 Servos 120°, 3 Servos 140° and 3 Servos 90°.

Setup: Press "ENT" to enter Main Menu, press UP or DN until "MODEL" flash, and then press "ENT" to enter Model Menu; Press UP or DN to choose "SWASH" press ENT enter to Swash setting interface.



Press UP or DN to choose the required swashplate type. Press ENT to confirm, the corresponding items will have the "✓" mark in front of the items. Press EXT to exit after finishing.

2.12 Fixed ID

Using the Fixed ID function allows users to create a unique relationship between transmitter model data and the corresponding model's receiver. It significantly speeds up the binding process and also prevents mistakenly flying an aircraft with the incorrect transmitter model selected.

(1) Fixed ID setup

To start the Fixed ID setup it is important that the transmitter and receiver have successfully completed automatic ID binding process. Once the transmitter and receiver are paired a Fixed ID can be set as described below.

Press the "ENT" button on the main panel and a flashing System will display in the LCD. Use UP or DN to cycle through the options until Model menu appears flashing. Press "ENT" again to enter into Model edit menu. Press UP or DN until a flashing "FIXID" is displayed, press "ENT" to enter the Fixed ID menu. The current status is displayed. Use R or L to toggle between modes and set to "ON". Press DN to confirm and enter the Fixed ID code setting screen.

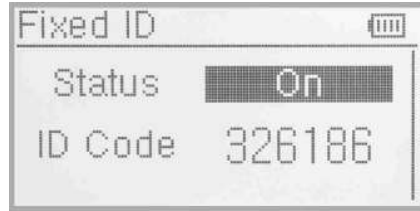
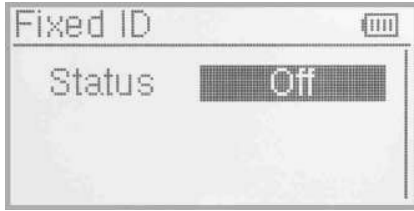

Press ENT to change the code data, use R and L to change the code values, press DN to move to the next digit, UP to move to the previous digit. There are 6 digits can be settled.

After setting the desired code press ENT, "RUN" will be displayed. Use R or L to change NO to YES and press ENT to confirm and execute the binding process. An inquiry interface of "Are you sure?" pop up. "ID Code Matching" will be shown after press ENT. After binding the display will return to the model menu automatically

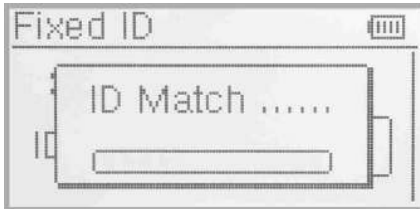
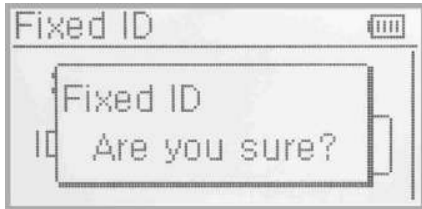

(2) Cancelling/Resetting the Fixed ID

If you wish to change the receiver Fixed ID model back to random ID, insert the included BIND PLUG into the output terminal BATT before the receiver is powered on. Connect 5V DC power to the Throttle channel. The red LED of the receiver will flash slowly. Remove the BIND PLUG. The Fixed ID code has been cancelled. After the receiver's Fixed ID is reset it should also be reset in the Transmitter. Here is the setup:

In the main interface press the ENT to enter Model Menu and then press UP or DN to move the navigational mark to select MODEL MENU. Press ENT to enter MODEL MENU. Press UP or DN to select Fixed ID code and press ENT key to enter the Fixed ID code interface. Press UP or DN to select STATUS option, Press R or L to change the status to Off. Then press EXT to exit.



2.13 Sensor Setup

Press ENT enter to the Main Menu. Press UP or DN to select the Model Menu. Press ENT enter to Model Menu. Press UP or DN to select sensor press ENT enter to the sensor setting interface. See the Illustration.



Press R or L to select Activate or Inhibit (the default setting is Inhibit), such as press Activate will includes No Signal Warning, Voltage sensor, Temperature sensor, GPS receiver setting etc.

(1) No Signal Warning

Press UP or DN to make the navigation mark to choose "No Signal Warning". Press R or L to choose "Inhibit" or "Active" (default setting is "inhibit"). If you choose "Active", the Radio will alarm when telemetry signal lost. As following:



(2) Voltage Setup

There are 3 different types of voltage can be measured. It includes Internal 5V, External V1 and V2 which can be monitored two different external voltage (i.e. battery) respectively. Once the measured voltage is lower than the setting value, the Radio will alarm.

(2.1) Receiver 5V (Internal) PFV (Power Feeding Voltage) Alarmed value can be set as 3.6-6V

Voltage Setup: press R or L to activate the 5V, the alarm interface will appear in the interface, please refer to the Illustration.

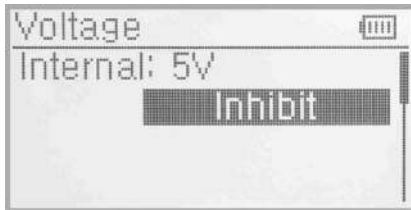

Press UP or DN to select the Alarm Voltage setting, press R or L to set the value. The range is 3.6-6V. you can continue to set other items after you finished.

(2.2) External V1

Press UP or DN enter to External V1 setting interface. Press R or L to activate the V1, the details refers to the Illustration.



Press UP or DN to select the Alarm Voltage setting. Press R or L to set the value. The setting range is 0.2~99.9V. you can continue to set other items after you finished.

(2.3) External: V2 setting can refer to External V1 setting.

Press EXT back to sensor setting interface after you finished.

(3) Temperature sensor

The temperature sensor can measure up to 4 different temperature (i.e. motors). You can choose Celsius or Fahrenheit. The alarmed value can be set to 4 different temperature. Once the measured value is higher than the setting value, the radio will alarm. The Alarm Temperature value can be set as -20~220°C or -4.0~428.0° F.

Temperature Setup:

In the "Sensor Setting" interface, press UP or DN to make the navigation mark to choose "Temperature Sensor", and press ENT to enter "Temperature Sensor" setting interface. See the illustration.



(3.1) Unit

Press UP or DN to make the navigation mark to choose "Unit" setting item, and press R or L to choose Unit, two kinds of Unit: Celsius and Fahrenheit.

(3.2) Alarm Temperature Setup

Press UP or DN select the T1, Press R or L to activate the setting. Inhibit will change to Active and Alarm temperature will be shown. If you choose Inhibit, the Alarm temperature value won't be shown.

Press UP or DN to select "Alarm" setting, press R or L to set the alarm temperature value. Press UP or DN to set other items after finishing the setting.



(3.3) T2,T3,T4 Setup

Refer to the step of “(3.2)T1”.

(4) GPS Setup

There are 4 items including Altitude Type,Speed Unit,Date Type and Time Zone in the GPS receiver setting interface.

Press UP or DN to select the Sensor setting interface to enter the GPS setting interface.

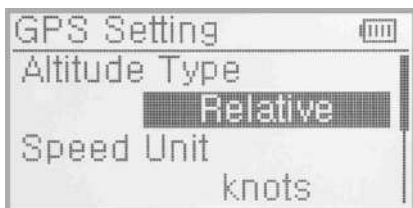

(4.1) Altitude Type

Press UP or DN to select the Altitude type on the GPS setting interface and it's Absolute and Relative.

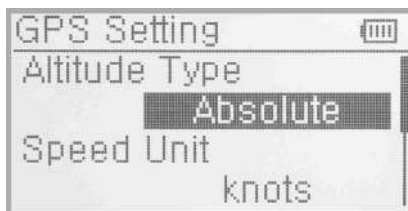

(4.2) Speed Unit

Press UP or DN to select the Speed Unit on the GPS setting interface and it includes knots and km/h and relative. Select the desired item.



(4.3) Date Type

Press UP or DN to select the Date Type on the GPS setting interface and it includes DD-MM-YY, MM-DD-YY and YY-MM-DD. Select the desired item.

(4.4) Time Zone

Press UP or DN to select the Time Zone, press R or L to set the desired Time Zone.



(4.3) Date Type



(4.4) Time Zone

3.0 Function Menu

The Function Menu allows you to customize the settings for your saved models. This menu includes the following: Reverse setting, Travel Adjustment, Sub Trim, Dual Rate/Exponential, Throttle Hold, Throttle Curve, Mix to Throttle, Gyro Sensor, Governor, Swash Mix, Pitch Curve, Program Mix, Monitor, Fail Safe, Trainer and Timer.

3.1 Reverse Switch

Press ENT in main interface to enter Main Menu; Press UP or DN to move the navigation mark to Function Menu. And press ENT to enter Function Menu, Press UP or DN to choose Reverse Switch and Press ENT to enter into Reverse Switch interface.

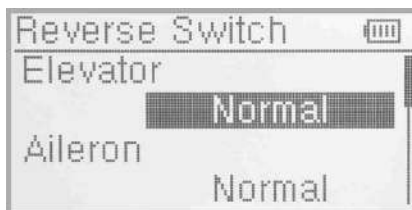

Press UP or DN to move navigation mark to ELEV(take Elevator for example), Press R or L to shift the status between normal and reverse. These are two status for option. And the default setting is Normal. All Channels Reverse Switch like: Aileron, Throttle, Rudder, Gear, Pitch and Aux2 can be referred to the way of ELEV Reverse Switch. And press EXT to exit after finishing setting.

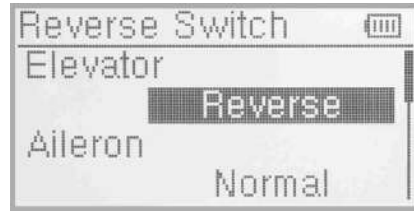

3.2 Travel Adjust

Press ENT to enter into Main Menu. Press UP or DN to move navigation mark to select item Function Menu. Press ENT to enter Function Menu. Press UP or DN to select Travel Adjust, Press ENT to enter Travel Adjust interface, as below illustration. It shows the Travel Adjust status of one channel:



Take ELEV for example, Press UP or DN to move navigation to desired item Elevation of U. Press R or L to increase or decrease the servo travel range. The adjustment range is from 0.0% to 150.0%. The factory default is 100.0%.

Press UP or DN to move navigation mark to desired item D of ELEV. Press R or L to increase or decrease the servo travel range. The range is from 0.0% to 150.0%. The factory default is 100.0%.

All other channel's Travel Adjust like Aileron, Throttle, Rudder, Gear, Pitch and Aux2 can be referred to ELEV travel Adjust. Press EXT to exit after setting finished.

3.3 Sub Trim

NOTE: Sub Trim is used to fine tune the servo neutral position during setup. In order to avoid pushing the servo beyond its limits and possibly causing damage it is advised to first mechanically adjust the servo arm/bell crank to be as close to the neutral point as possible. Only when this is complete may sub trim be used to make a final adjustment.

Setting method:

Press ENT to enter Main Menu, Press UP or DN to move the navigation mark to desired item Function Menu. Press ENT to enter Function Menu, Press UP or DN to select Sub trim, and press ENT to enter Sub Trim interface.

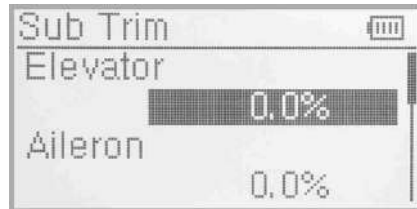

The interface shows the items and the channels which are adjustable. Press R or L to change the neutral point of Servos. The default for every channel is 0.0%. The permitted adjustment ranges are shown in the table below:

Channel name	Adjustment range	Channel name	Adjustment range
Elevator	D62.5%~U62.5%	Gear	-62.5%~+62.5%
Aileron	R62.5%~L62.5%	Pitch	L62.5%~H62.5%
Throttle	L62.5%~H62.5%	AUX2	-62.5%~+62.5%
Rudder	R62.5%~L62.5%		

Press EXT to exit after adjustment finished.

3.4 Dual rate and Exponential

Dual Rate/Exponential is a function which permits a change in behavior of the control sticks between pre-defined settings. Dual Rate alters the maximum and minimum servo travel available, Expo has no effect on the maximum or minimum travel but decreases or increases the sensitivity to stick movement in an exponential manner. One use of Dual Rate/Expo is to reduce the sensitivity of the controls when landing.

Setting method:

Press ENT to enter Main Menu. Press UP or DN to move navigation mark to desired item Function Menu. Press ENT to enter Function Menu, press UP or DN to choose Dual rate and Exponential, Press ENT to enter D/R and Exponential interface.

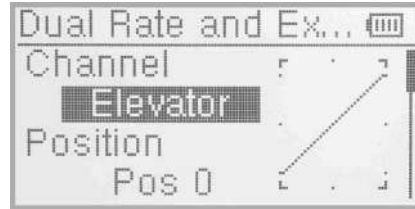

(1) Channel selection

Press UP or DN to move navigation mark of Channel, Press R or L to set up channels containing Elevator, Aileron and Rudder. Choose the desired channel for setting.

(2) Position selection

Press UP or DN to move navigation mark to desired item Position. In the manual mode, the function of Dual rate and Exponential will be executed by the corresponding FMOD switch among Pos0 and Pos1. Take the item Elevator at channel as an example, It's possible to shift between Pos0 and Pos 1 via pushing or pulling the FMOD switch.

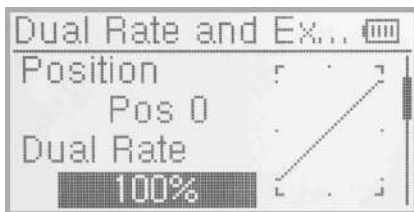

(3) Dual rate adjustment

Press UP or DN to move the navigation mark to desired item Dual Rate. It's possible to change the dual rate value of Position via pressing R or L and the corresponding value curve in the right top of interface will be changed accordingly. The factory default is 100%.

(4) Exponential

Press UP or DN to select Exponential item of navigation mark. It's possible to change Dual Rate and Exponential value in Pos when pressing R or L to change the value. There are $\pm 100\%$ and Line three adjustment. At the same time, the corresponding curve will be changed and shown at the right graph.

(5) Normal Mode

Press DN to move the navigation mark to "Normal Mode", press R or L to choose Pos0, Pos1 and Pos2.

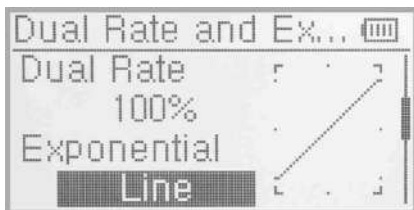

(4) Exponential

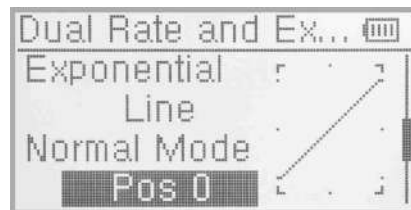

(5) Normal Mode

(6) Stunt Mode: Refer to "(5) Normal Mode"

Press EXT to exit after finishing the setting.

3.5 Throttle Hold

If the throttle hold function is activated in the function settings menu, it can be operated by the Throttle Hold switch as shown in the picture below. The permitted setting range is from -20.0% to 50.0%. The default setting is inhibited.

Setting method:

Press ENT to enter Main Menu, Press UP or DN to move navigation mark to select Function Menu. Press ENT to enter Function Menu. Press UP or DN to select Throttle Hold, Press ENT to enter Throttle Hold interface, as below illustration:



Press R or L to activate Throttle Hold function, and expansion list will be shown as Throttle hold status, Throttle hold position and Throttle hold switch.

(1) There are two items under Throttle Hold Status: Active and Inhibit. The factory default setting is Inhibit.

(2) Throttle Hold position

In the Throttle Hold interface, press UP or DN to make the Navigation mark to choose "Throttle Hold Position" setting options. Press R or L to change data, the minimum value is -20.0%; the maximum value is +50.0%.

(3) Throttle Switch setting

It's invalid for setting, the factory default is HOLD switch which will be shown in the status item. When the Throttle Hold switch is ON, data under the Throttle Hold can not be amended until Throttle Hold switch to be OFF, and the hold status is changed.

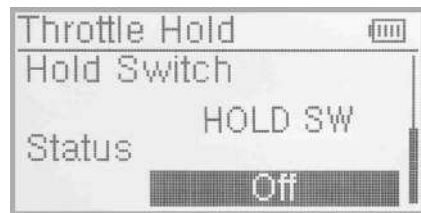

Press EXT to exit after setting up finished.

3.6 Throttle Curve

Throttle curve are adjusted through seven points, which of all the flight modes can be respectively set. The flight mode include Normal Flight, Stunt.

Press ENT to enter main menu, Press UP or DN to move navigation mark to select Function Menu. Press ENT to enter Function Menu. Press UP or DN to select Throttle Curve, Press ENT to enter Throttle Curve interface. The enquiry dropdown is shown "All servos hold?" If click OK, all the servos will be locked at the current status, if click Cancel, all the servos will be unlocked at the current status.

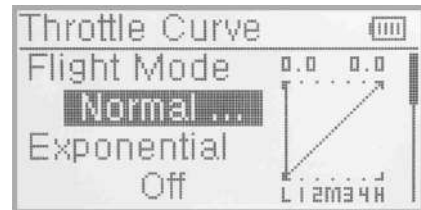
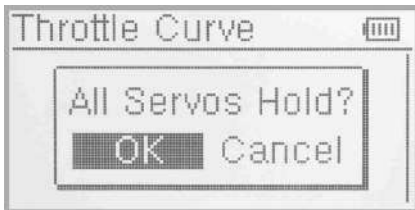

(1) Flight Mode

There are total two flight modes: Normal Flight, Stunt. The Curve of which can be respectively set in their corresponding flight mode. The setting method is to press UP or DN to select Flight Mode in Throttle Curve interface. The corresponding flight mode will be shown when the Flight Mode switch shifts via pushing or pulling the Flight Mode Switch. And the exponential can be adjusted after Flight Mode is selected.

(2) Exponential Adjustment

Press UP or DN in Throttle Curve interface to move navigation mark of exponential curve and press R or L to set the exponential function Off and On. The throttle curve will be changed smoothly if touching ON, or in fold line if clicking OFF.

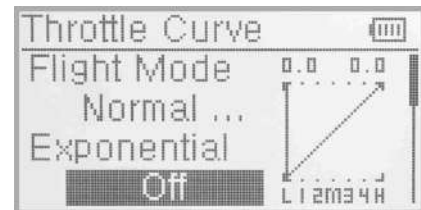

(3) Curve setting

It includes two items: Point and Output.

(3.1) Adjustment for Point

Press UP or DN in Throttle Curve interface to move the navigation mark to desired item Point. Press R, an expansion list including “-L” “-1”, “-2”, “-M”, “-3”, “-4” and “-H” seven points is shown and can be selected via pressing R or L.

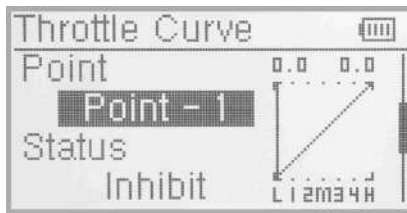
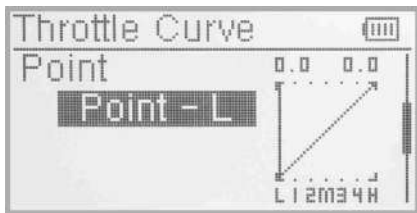

(3.2) Status adjustment

Press UP or DN to move navigation mark to Status and press R or L to choose Inhibit or Activate. Click Inhibit if you don't amend the amount of the selected point. The factory default is Inhibit. Click activate if you want to amend the amount of the selected point.

(3.3) Output adjustment

An expansion list of Output items will be shown after activating the Status. Press UP or DN to move navigation mark to select Output item. And press R or L to increase or decrease the amount of selected point with a minimum of 0.0% and a maximum of 100.0%.

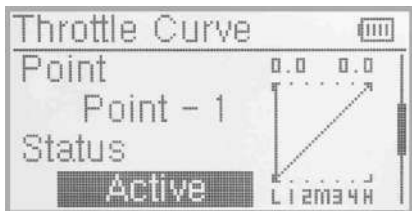

(3.2) Status adjustment

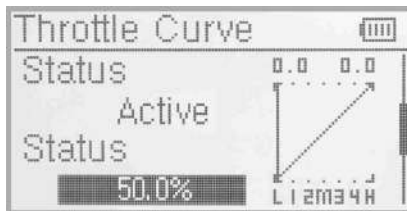

(3.3) Output adjustment

Press EXT to exit after finished.

3.7 Mix to throttle

The Mix to Throttle function is designed to permit the main rotor speed to remain constant despite a change in load when operating the aileron, elevator or rudder. Generally, it is not advised to use this function except when stunt flying.

Setup:

Press ENT to enter Main menu in the main interface. Press UP or DN to move navigation mark to select Function Menu. Press ENT to enter function menu. Press UP or DN to select Mix to Throttle. And press ENT to enter Mix to throttle interface as in below illustration.

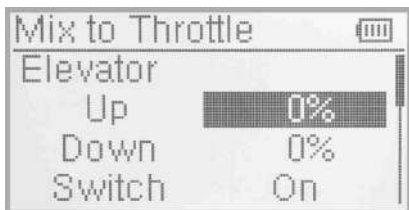

There are three settings: elevator, aileron and rudder. If the item of Channel is shown as Elevator, there are UP, DOWN and Switch in the interface. If the item of Channel is Aileron or Rudder, the contents in the said interface will be changed into Left, Right and Switch. Take the example of Channel set as Elevator to illustrate the setting method.

(1) Up setting

In the Mix to throttle interface, press UP or DN to move the navigation mark to select UP item. Press R or L to increase or decrease the mix amount when moving the throttle stick upwards. A positive MIX value means that as ELEV channel output value is increased (when flying forward), the THRO value will also be increased automatically. A negative MIX value means that as ELEV channel output value is increased (when flying forward), the THRO value will be decreased automatically. The available range of adjustment is ±125% .

(2) Down setting

Once the values for UP are set press DN to show the current MIX setting for DOWN (ELEV input to fly backwards). In the interface of Mix to Throttle, press UP or DN to move the navigation mark to select Down item. Press R or L to increase or decrease, respectively, the mix amount when moving the throttle stick downwards. A positive MIX value means that as ELEV channel output value is decreased (when flying backwards), the THRO value will also be increased automatically. A negative MIX value means that as ELEV channel output value is decreased (when flying backwards), the THRO value will be decreased automatically. The available range of adjustment is $\pm 125\%$.

(3) Switch Selection

In the interface of Mix to Throttle, press UP or DN to move the navigation mark of Switch and press ENT to enter Switch interface. There are Always on, Normal Mode, Stunt Mode options. Press UP or DN to select the Switch option. Press ENT to make a “√” mark to the choosed switch. Press EXT to the interface of Mix to Throttle. Press DN to setup the Aileron or Rudder.

(4) Aileron or Rudder Mix to Throttle setup can be referred to Elevator setting.

Press EXT after finished.

Note:

(1) Before flight, please confirm: All above amount of mix to throttle is proper enough to ensure a good flight. And make sure all the actions in different flight mode are normal.

(2) The function is in spare when governor is working.

3.8 Gyro sensitivity

This function offers the gain adjustment for gyro sensitivity, which can be manually set through HOLD switches, and also is possible to be automatically switched among various gains through flight mode switch.

Setup:

Press ENT to Main Menu, use UP or DN to choose function menu. Press ENT to function menu. Press UP or DN to choose Gyro Sensor, then press ENT to Gyro Sensor interface.



(1) Manual Setting

(1.1) Manual Setup

In the Gyro Sensor interface, press UP or DN to choose

Mode, there are Manual set and Automatic set for selectable choice. Press R or L to select Manual option.

(1.2) Channel

The factory default channel is AUX2, the Output set offer the function to change other control channels (Refer to “2.10 Output”).

(1.3) Switch Select

In the interface of Gyro Sensor, press UP or DN to choose SWITCH, press ENT to SWITCH, there are FMODSW and HOLDSW for selectable sets, press R or L to choose the desired switch for Manual control.

(1.4) Sensitivity Setup

There are Position 0 and Position 1 two selection which can set the sensitivity individually.

(1.4.1) POS 0

Choosing MANU and then pressing ENT shows the SWITC status. This indicates the switch to which GYRO sensitivity settings are assigned. Default is HOLD SW.

Pressing DN displays the switch position and assigned GYRO value. The first POS setting displayed is POS 0, pressing DN again displays POS 1. To change the value use the R or L buttons. The GYRO has two modes of operation; AVCS or NOR. When the value is set greater than 50% AVCS will be activated. AVCS is also known as Heading Hold or HH gyro. The bigger the value the bigger the gyro sensor heading gain becomes, or the harder it tries to maintain the heading.



The NOR mode, also known as RATE mode, is activated by setting the value to less than 50%. The smaller the value the greater the gyro sensor rate gain becomes, or the harder it tries to maintain a constant YAW rate.

Once POS 0 is set as desired, use DN to set POS 1 setting as required. Typical values are POS 0 = 75%, POS 1 = 50%. Default values are all 50%.

(1.4.2) The POS 1 setup is the same as above POS 0.

(2) Automatic setting

(2.1) Automatic Setup

In the Gyro Sensor interface, press UP or DN to choose Mode, there are Manual set and Automatic set for selectable choice. Press R or L to select Automatic option.



(2.2) Channel

The factory default channel is AUX2, the Output set offer the function to change other control channels (Refer to "2.10 Output").

(2.3) Switch Select :No use in Automatic Setting.

(2.4) Status

Turn the Flight mode Switch or Throttle hold Switch, the status set will display the current flight mode position. There are Normal Mode, Stunt Mode and Throttle hold available. The Throttle hold need to activate to use. (Refer to "3.5 throttle hold")

(2.4.1) Normal Mode

Press UP or DN to Normal Mode, press ENT to Normal mode. Use R or L to set the value individually. The GYRO has two modes of operation; AVCS or NOR. When the value is set less than 50% ,it is NOR mode. the smaller the value is, the greater of the GYRO sensor rate gain becomes, or the harder it tries to maintain a constant YAW rate. The factory default value is 50%.

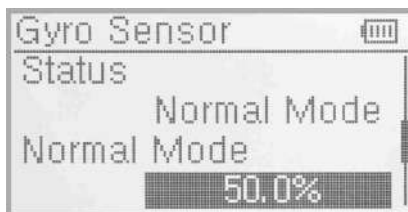

(2.4.2) Stunt Mode and Throttle hold setup refer to Normal Mode.

After finished the setting, press EXT to exit.

Notes: The Gyro sensitivity setting just can be set when there is a gyro menu listed in Output in Mode Menu. (Refer to "2.10 output")

3.9 Governor

To setup Governor, the Governor needs to be active under the Device Output menu (Refer to section 2.10 Device Output).

The Governor function is a feature which, when enabled, automatically tries to maintain a constant main rotor speed. It is possible to setup different Governor settings for each flight mode. On the transmitter, the display is a percentage for reference/adjustment, the actual rotation speed is set by the governor.

Setup:

Press ENT to Main menu in the interface, use UP or DN to choose function menu. Press ENT to function menu. Use UP or DN to choose Governor, then press ENT to the Governor setting interface, there are status and channels. Press UP or DN to the Normal Mode, Stunt Mode or Throttle Hold.

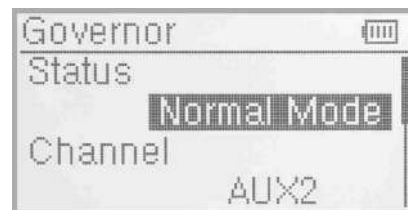

(1) Status

Toggle the Flight Mode or Thottle Stick Lock switch, the status display present flight mode position. There are Normal Mode, Stunt Mode and Throttle Hold. Throttle hold need to activate. (Refer to 3.5 throttle hold)

(2) Channel: Setup refer to 2.10 Output

(3) Normal Mode

Press UP or DN to choose Normal Mode, press R or L to increase or decrease the value. The factory default value is 0%.

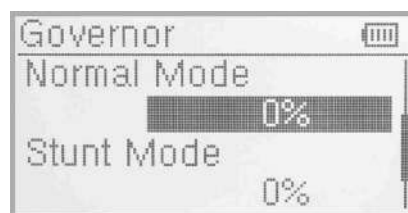

(4) Stunt Mode and Throttle Hold setup refer to Normal Mode(3)

After finished, press EXT to exit.

3.10 Swash Mix

This function, which can be executed through flight mode, is used for amending the variation caused by s washplate movement, when the aileron or elevator is working.

Press ENT to Main Menu, use UP or DN to choose the navigation mark of enter Function Menu. Press ENT to Swash Mix interface. The Swash Mix item is only effected after choose the two or more servos in 2.11 Swash Type .Take the third servo 120° as an example.



(1) Swash Type

This function permits the flight adjustment of swashplate behavior.The item is only active when the swashtype is 2 servos or more in 2.11 Swash Type. The choosed swash type is the 3 servos 120° .

Setup: Enter the FUNCTION menu and select SWHMX. Press ENT to display the first of the available channels for adjustment and it's current setting value. When swash type is set to 3 servos 120° , four options are available, ELEV, AILE, PITCH and EXP.

(2) Aileron Mix Adjustment

In the interface of Swash Mix,press UP or DN to choose the navigation mark of Aileron Setting item. Press R button to increase the rate and L to reduce. If reversed direction, it is available to chang through the "+" or "-" mark. The adjustable rate is ±125%. After finished the settings, press DN to set others.

(3) Elevator mix adjustment

The function is based on the 3 servos or more servos which is choosed(refer to the 2.11 Swash Type). The setting method is same as above.



(4) Pitch Mix Adjustment

The function is based on the 2 servos or more servos which is choosed(refer to the 2.11 Swash Type). The setting method is same as above.

(5) Exponential Curve

This function can execute the exponential changes, which are set at Dual Rate and Exponential in Function Menu when it is started. If Off is selected, the exponential curve will be changed in the form of fold line.



Setup:

Press UP or DN to touch the navigation mark of Exponential to expand two options: Off and On. the default setting is Off. On is recommended.

Press EXT to exit after finished.

3.11 Pitch Curve

Pitch curves are adjusted through 7 points, which of all the flight modes can be respectively set. There are "Normal Mode", "Stunt Mode" and "Throttle hold" 3 flight modes.

Setup:

Press ENT to Main Menu. Press UP or DN to choose Function Menu and then press ENT to enter Function Menu. Press UP or DN to choose Pitch Curve, press ENT to Pitch Curve interface, there is "All servos hold?", Press ENT to confirm with OK for all the servos will be locked at the current states.Or use UP or DN to Cancel for Unlocked. Enter the next interface after confirmed OK or Cancel.

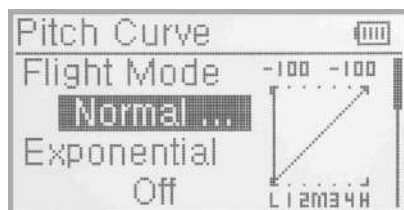

(1) Flight mode

Press UP or DN to enter the Flight Mode interface of Pitch Curve, The Pitch Curve can be set at the current state. Setup: Move the flight mode switch, FMODE or HOLD, the state of flight mode will be shown. There are Normal Mode, Stunt Mode and Throttle hold 3 flight modes. Take Normal Mode as an example for your reference.

(2) Exponential Setup

Press UP or DN to choose Exponential Curve. There are On or Off option. Use R or L to choose On or Off. The Pitch Curve will become round if chosen ON (Refer to step 3). The Pitch Curve Function stay normal when choose OFF.

(3) Point Setup

Press UP or DN to enter the setting interface of Curve Point. Press R or L keys of setting curve point, there are 7 points ; point-L, point -1, point -2, point -M, point -3, point -4 and point -H. Choose the desired point for adjusting.

(4) Status Setup

After choosed the curve point, use UP or DN to choose the Status. Press R or L, there are two options, Inhibit and Active (Remark: When Point choose point -L or point -H, there is no status shown in the menu). Use R or L to choose Inhibit If you don't want to change the point data, the factor default setting is inhibit. Use R or L to active If you want to change the point data. Output will be expanded.

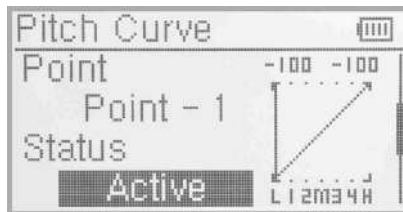

(5) Output Setup

Press UP or DN to choose Output, Use R to increase point's output value, the maximum amount is +100%. press L to decrease point' output value, the minimum amount is -100%.

(6) There are Normal Mode, Stunt Mode and Throttle hold 3 flight mode. The Pitch Curve can be set respectively at different models. The setup is same as above. Press EXT to exit after finished.

The basic examples are only for your reference. Adjustment to the real flights is a must.

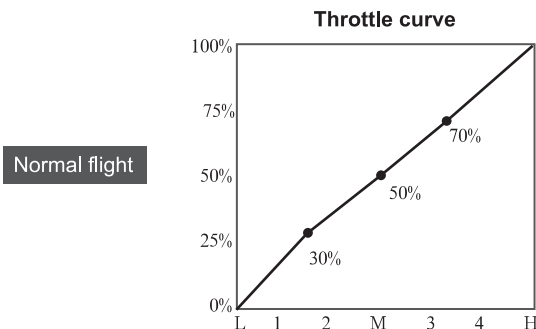

Normal flight

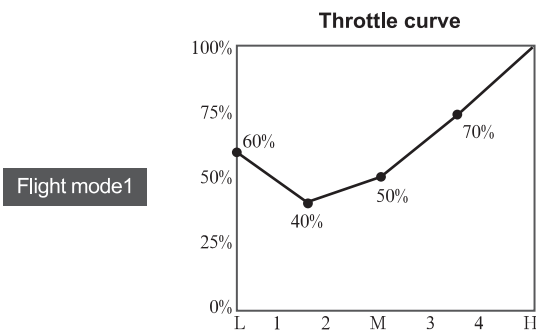
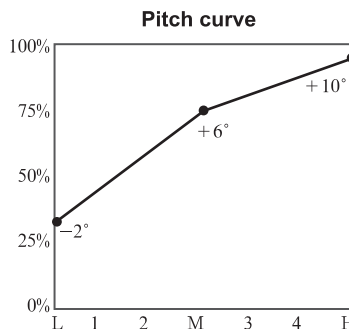

Flight mode 1

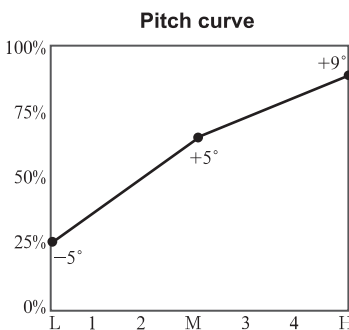

Flight mode 2

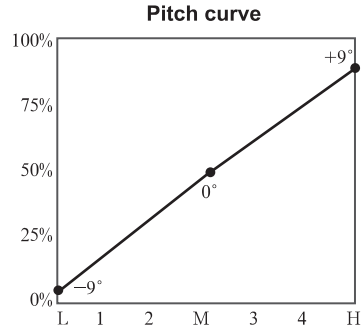
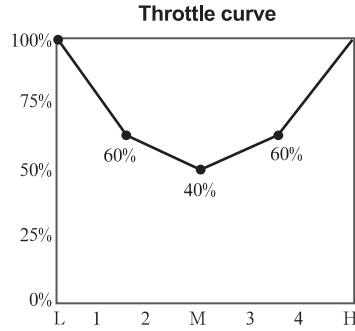

Autorotation landing

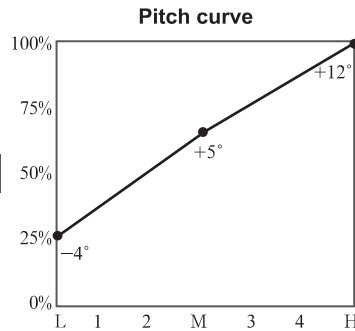

3.12 Program Mix

There are 8 series of Program Mix, the Mix channels and values are adjustable.

Setup:

Press ENT to Main Menu, press UP or DN to Function interface. Press ENT to Function Menu. Use UP or DN to select Program Mix. And press ENT to Program Mix interface. The current status is Program Mix 1 interface. Use R or L to select between 3 options, Inhibited, Normal or Curve.

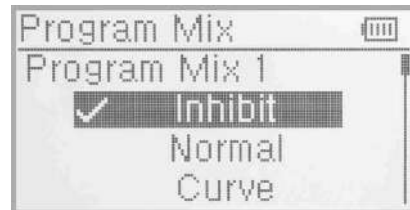

Take Program Mix 1 memory for example, there are Inhibit, normal and curve. The default setting is Inhibit.

(1) Normal Setting of Program Mix 1

Use UP or DN to select Normal, press ENT to confirm. Then the interface pop up "All Servos Hold?" Press R or L to choose OK or Cancel. If select OK, all the servos will be locked in the current status, if select Cancel, all servos are unlocked. Press ENT to Program Mix setting interface.

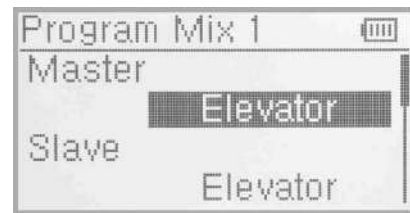

(1.1) Master(Main channel) Setup

Use UP or DN to select Master, press ENT to Master interface. Pressing UP or DN to select the desired channel, there are Elevator, Aileron, Throttle, Rudder, Gear, Pitch, AUX2, #Elevator, #Aileron, #Pitch, #Rudder, *Elevator, *Aileron, *Throttle, *Rudder, Flight Mode for choices. Press ENT to make a "✓" to confirm the choosed item. Press EXT to go back to previous Program Mix 1 interface .

(1.2) Slave channel Setup

Press UP or DN to select Slave and press ENT to Slave interface. Use UP or DN to select the desired channel, there are Elevator, Aileron, Throttle, Rudder, Gear, Pitch and Gyro for choices. Press ENT to make a "√" to confirm the choosed item. Press EXT to go back to previous Program Mix1 interface.



(1.1) Master(Main channel) Setup



(1.2) Slave channel Setup

(1.3) Gain Setup

Once Main and Slave channels have been set, press DN to display the Gain setting. The gain setting controls the slave channel output in proportion to the main channel setting. A higher gain value will result in a greater change in output. A negative gain setting will result in a change in the opposite direction with respect to the main channel. Take Elevator as an example.

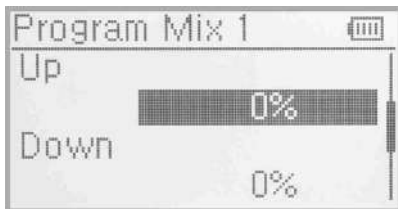

(1.3.1) UP Setup:

Mix amount setting when elevator stick moved upward. Press UP or DN to move the navigational mark to select Up to item. Use R/L to increase/decrease the mix amount. It is possible to reverse mix direction through changing the + or - sign before amount. The adjustable range is $\pm 125\%$.

1.3.2) Down Setup:

Mix amount setting when elevator stick moved backward. Use

UP or DN to select Down item. Press R/L to increase/decrease the mix amount. It is possible to reverse mix direction through changing the + or - sign before amount. The adjustable range is $\pm 125\%$.

1.3.3) Offset Setup:

Using the Offset function it is possible to apply a slave channel correction even at the 0 position on the main channel. It is also possible to enable or disable the Offset based on a designated switch position. Press DN after setting 1.3.2 to display the Offset setting value. Use R and L as before to set the desired value. Use R and L as before to set the desired value. The permitted adjustment range is -100% to +100%.

(1.4) Switch Selection

Use UP or DN to choose Switch. Press ENT to enter the interface of Switch. There are Always On, Normal Mode, Stunt Mode, Throttle Hold for permitted choices. Press UP or DN to choose the desired item. Press ENT to confirm and marked with "√".

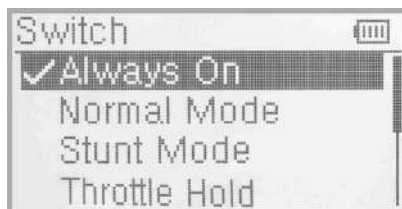

(2) Curve Setting of Program Mix 1

Use UP or DN to select Curve, press ENT to confirm. Then the interface pop up "All Servos Hold?", Press R or L to choose OK or Cancel. If select OK, all the servos will be locked in the current status, if select Cancel, all servos are unlocked. Press ENT to setting interface of Program Mix1. The interface will show the setting items and curve table as below :



(2.1) Master(Main channel) Setup

Use UP or DN to select Master, press ENT to Master interface. Pressing UP or DN to select the desired channel, there are Elevator, Aileron, Throttle, Rudder, Gear, Pitch, AUX2, #Elevator, #Aileron, #Pitch, #Rudder, *Elevator, *Aileron, *Throttle, *Rudder, Flight Mode for choices. Press ENT to make a “√” to confirm the choosed item. Press EXT to go back to previous Program Mix 1 interface .

(2.2) Slave channel Setup

Press UP or DN to select Slave and press ENT to Slave interface. Use UP or DN to select the desired channel, there are Elevator, Aileron, Throttle, Rudder, Gear, Pitch and Gyro for choices. Press ENT to make a “√” to confirm the choosed item. Press EXT to go back to previous Program Mix1 interface.



(1.1) Master(Main channel) Setup



(1.2) Slave channel Setup

(2.3) Exponential Curve Setup

Press UP or DN to choose the setting item of Exponential Curve .There are ON or OFF option when you press the R or L buttons. The Curve Pitch will become round if the ON button is choosen.If you don't adjust the Pitch Curve Funtion, then choose OFF button.

(2.4) Point Setup

Press UP or DN to Point interface. Press R or L to select Point between Point-L,Point -1, Point -2, Point -M, P oint -3, Point -4 and Point -H. Choose the desired point to adjust.

(2.5) State Setup:

(Remark: When Point choose point -L or point -H, there is no status shown in the menu) After selecting the point that you want to set, press UP or DN to move the navigational mark to Status item. Press R or L, there are two options of Inhibit and Active. Select Inhibit for unchanging the current amount (the default setting is Inhibit).

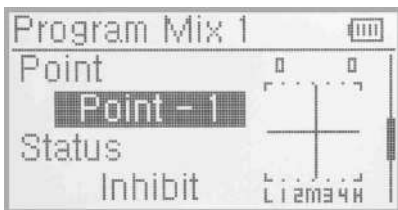

(2.4) Point Setup

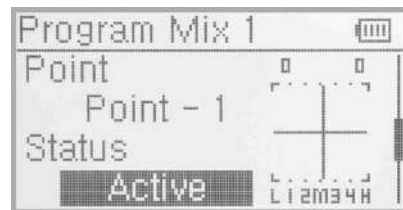

(2.5) State Setup

(2.6) output setting

Press UP or DN to choose Output, Use R to increase point's output value, the maximun amount is +100%. press L to decrease point' output value, the minimum amount is -100%.

(2.7) Switch Selection

Use UP or DN to choose Switch. Press ENT to enter the interface of Switch. There are Always On, Normal Mode, Stunt Mode, Throttle Hold for permitted choices. Press UP or DN to choose the desired item. Press ENT to confirm and marked with “√”.

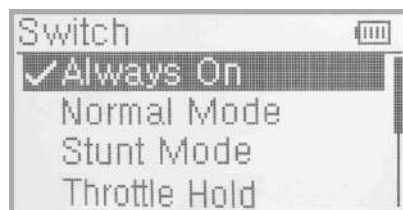
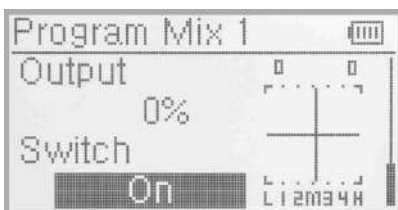

Press EXT to return to the previous interface or press EXT to exit after finished .

3.13 Monitor

The monitor function allows the pilot to monitor the outputs of each transmitter channel.

Press ENT to Main Menu, and use UP or DN to select Function Menu. Press ENT to enter the Function Menu and then use UP or DN to select Monitor and press ENT to enter the monitor interface for checking the current working status of each channel (See rightside View). Press EXT to exit .

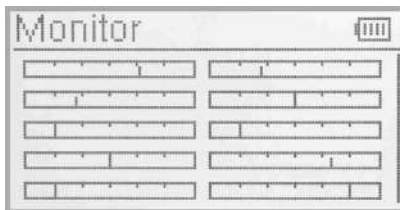

3.14 Fail safe

Two options exist if the receiver loses the connection with the transmitter; the first is HOLD - keep the last action data received, the second is to use a pre-set failsafe value. The default setting is Servo Hold.

Setup:

Press ENT to Main Menu, use UP or DN to select Function Menu. Press ENT to Function Menu then use UP or DN to select Fail Safe and press ENT to enter the Fail Safe interface. Take the item Elevator as an example to explain.



Use UP or DN to select Elevator on the Fail Safe interface, then press R or L to change the status of Servo Hold into Fail Safe (If you want to keep Servo hold status, there is no need to re-set). There is an expanded sub-item below. Press UP or DN to select 0%, then press R or L to increase or decrease the value, respectively, the position amount which centers on the neutral point of servo. The available value is 125%, respectively. 0% is the neutral point of servo.



The setting methods for other channels are same as above. Press EXT to exit after finished.

NOTE: If the helicopter enters a failsafe mode for any reason power should be disconnected from the Heli and it must be thoroughly checked over before flying again. Using 100% throttle after a failsafe event may be dangerous and cause injury or damage.

3.15 Sensor View

The function can be performed by Activate the Sensor Status in the Model Menu, and it is a must that the receiver also has telemetry function.

Sensor View Setup: Press ENT to enter the Main Menu and use UP or DN to select the Function Menu. Press ENT to Function Menu. Use UP or DN to select Sensor View, then press ENT to enter the Sensor View interface. See below views. If all the sensors disconnect, there will be inhibits shown on the view, means the telemetry signal lost. If all work normal, all the measured data will be shown.

(1) Voltage: Provide 3 different measured voltage values;

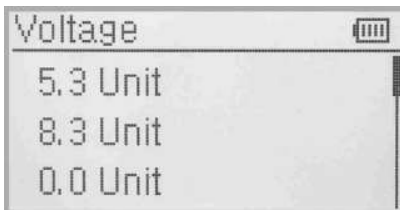
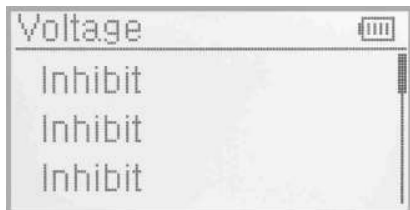

(2) Temperature: Press UP or DN to Temperature, which provides 4 different measured temperature values;

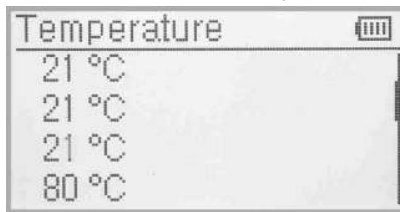

(3) Rate Sensor: Press UP or DN to Rate Sensor, which provide 2 different measured RPM values;

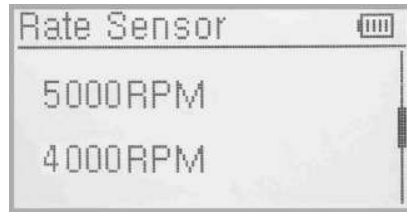

(4) GPS Sensor: Press UP or DN to turn to GPS Sensor, show located date, time, longitude, latitude, altitude and speed;

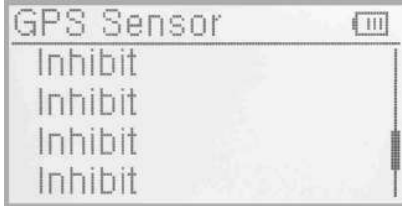

3.16 Trainer

To help the beginner pilot it is possible to make two DEVO 7E transmitters operate together using a training function. The training function permits the teacher to limit or override the controls of the trainee. The instructions for using the training function are below:

(1) Data copy

The first step is to copy the model settings from the teacher's DEVO 7E to the trainee's DEVO 7E, this guarantees that the model data in both transmitters is identical. To do this refer to the copy method as described in Helicopter setup section "2.4 model wireless copy". Once completed, follow the steps below:

(2) Connection

Insert the signal wire (supplied) into the DSC socket of the trainee's transmitter. Turn on the trainee's transmitter and the display will alternate between showing PC (data connection mode) and the model name (MOD), see image (right) from the trainer's transmitter into the DSC socket of the trainee's transmitter. Turn on the transmitter and a linkage icon will be shown on the boot screen.

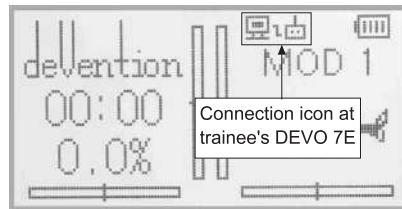

Linkage Display

Next, turn on the Trainer's DEVO 7E. Select the newly copied model data using the MODEL Menu. Bind to the aircraft and make a small test flight to confirm the aircraft is operating normally. Turn off the power and insert the digital signal wire into the trainer's DEVO 7E DSC port. Turning back on the power will automatically put the DEVO 7E into training mode.

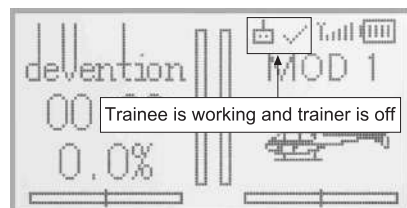

Trainer icon

Training Status Display: when the trainer's icon turns to "X", the trainee stops flying and the trainer is working; when the trainer's icon turns to "✓", the trainee is flying and the trainer is in leisure.

(3) Usage

The default setting of the training switch is "R+" key. During flight, if the trainer press "R+"key,the linkage icon will be shown as "✓" that means the control right is moved to the trainee from trainer. If trainer pushes "R+" key once again, the linkage icon will be show as "X" that means the trainer takes back the control right from the trainee.

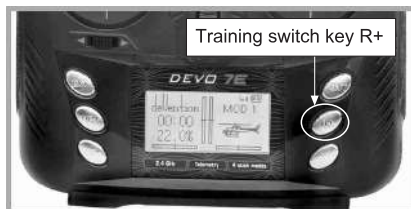

(4) Setting for training function channels

Trainee is available to get full or part of flight control power to the aircraft model via setting the training function channel in the trainer's radio. Below is the Setup:

Press the ENT to Main Menu, use UP or DN to Function Menu. Use UP or DN to select Trainer and press ENT to enter Trainer interface. The available channels are shown between Elevator, Aileron, Throttle, Rudder, Gear, Pitch and Gyro, and the current status of trainer switch is also shown there.

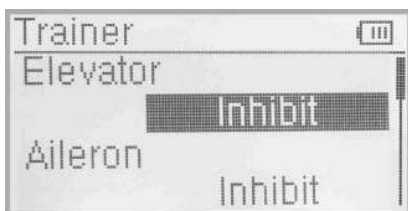

Channel selection:

Press UP or DN to select the channel option; press R or L to select the channel(s) which you want to grant to trainee. The channel(s) you have selected will be activated as "Active". The channel(s) which are not granted to trainee will be kept inhibited. The default setting is "Inhibit".

Press EXT to exit.

3.17 Timer

There are two timers on the DEVO 7E, stopwatch and countdown timer. These timers are activated by switch or by shortcut.

Setup:

Press ENT to Main Menu, use UP or DN to Function Menu. Press ENT to enter Function Menu. Use UP or DN to choose Timer, and press ENT to enter Timer setting interface. The factory default is Stopwatch, and the timing range of stopwatch is from 0 to 60.

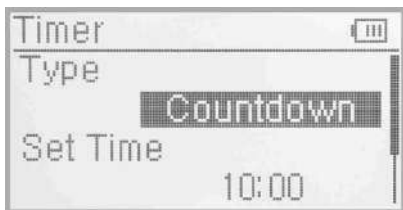
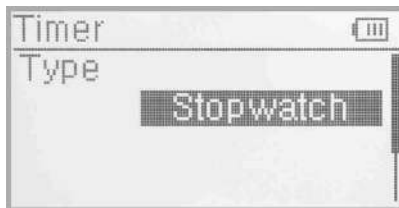

(1) Countdown setting

Press R or L to select Countdown. There is an expand sub-menu Set Time. Press UP or DN to Set Time interface, use R or L to set up countdown time. The timing rang is from 00:10-to 60.

(2) Switch selection

Press UP or DN to move the navigational mark to Switch. There are Inhibit and available switch options, use L or R to choose switches between FMODE SW, HOLD SW, SPS0 SW, SPS1 SW, SPS2 SW and SPS3 SW. Select the desired item except these items of SPS0 SW, SPS1 SW, SPS2, and SPS3 which should be previously set at Stick Position Switch at Model Menu (refer to "2.8 Stick Position Switch"). Press EXT after finished.

(3) Usage of timer

Use the UP key to start and stop the timer. Use DN to reset the timer. You can also set switches to control the timer. Below is the picture of timer display on the boot screen .

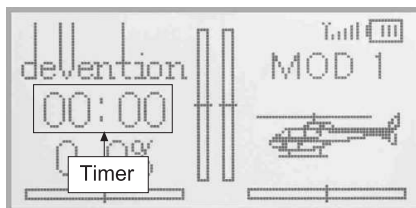

Part three Airplane

All the function settings, which are relative to the operation system of DEVO 7E itself, are fully integrated in System Menu. They include Language, Display, Buzzer, vibrator, Stick Mode, Stick Direction, Stick calibration, and About.

Setup your DEVO 7E transmitter for the best Airplane performance with the following sections. Included are specific functions for fixed wing features; Flaps and Servo Balancing are covered below.

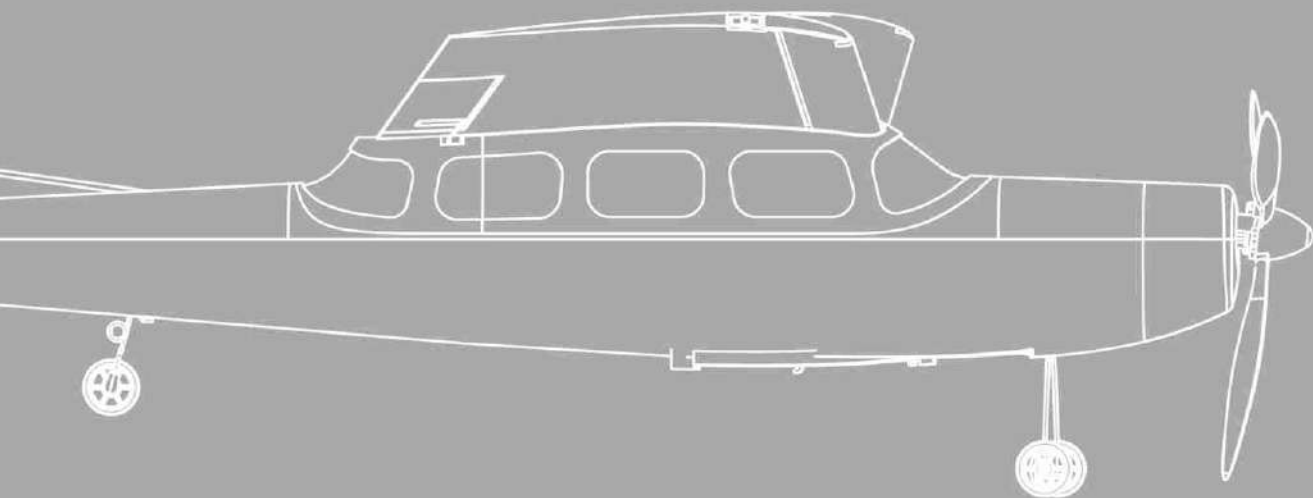

1.0 System Menu

This section describes the settings which are specific to the operation of the DEVO 7E itself. Settings for Language, Display, Buzzer, vibrator, Stick Mode, Stick Direction, Stick Calibration and About (Firmware) can all be accessed via the System menu .

Below is the boot screen of Airplane:

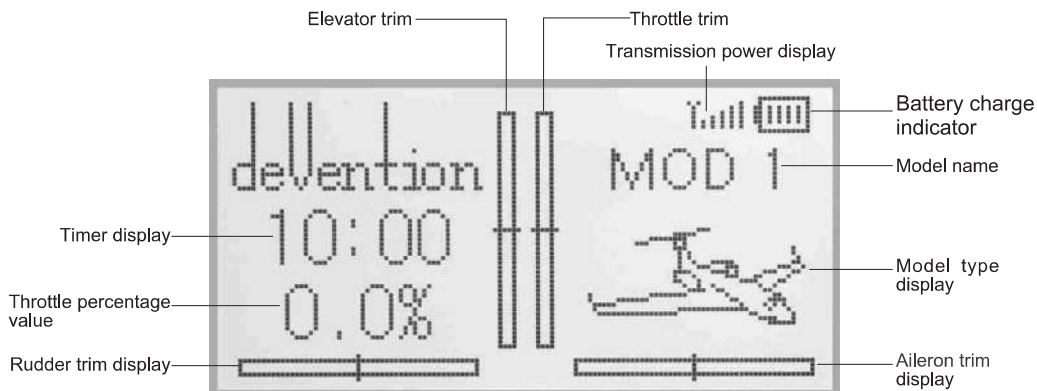

1.1 Setup Language

Choose the native language for the DEVO 7E. Here is the setup: Press ENT to enter System Menu and then press UP or DN to move the navigational mark to select System menu. Then push ENT to enter System menu .Press UP or DN to select Language and press ENT to enter the language interface. Press UP or DN to select the language that you desire. A " ✓ " will be shown on the screen after selected. Push EXT to exit.

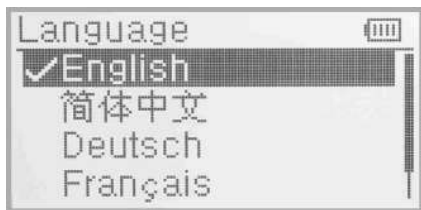

1.1 Language setup

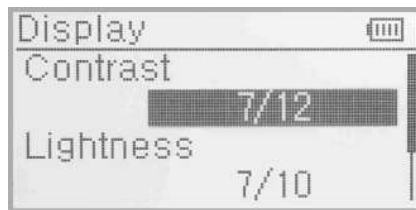

1.2 Display

1.2 Display

Three items are available to be set for Display:

- (1) Backlight contrast: the backlight contrast is adjustable by using UP or DN buttons to move the navigational mark to the digits after Contrast. Press R key to increase the backlight contrast, while press L to decrease it.
- (2) Backlight intensity: the backlight intensity is adjustable using the up or DN buttons. Power consumption will be increased when intensity is high and battery life will be reduced. When the value is one means turn off the backlight.
- (3) Backlight timeout: the duration for which the LCD stays lit can be configured from 5 to 60 seconds in 5 second intervals or set to "Always On".

Below are the setup:

Press ENT to enter the main menu, use UP or DN to move the navigational mark to select system menu. Press ENT to enter the System sub-menu, use UP or DN to select Display to enter "DISPL" interface. Press DN to enter the Backlight time-out setting, use R or L to adjust the period up to 60 seconds, using a setting of 0 means always on. Press ENT to confirm and EXT to exit to main menu.

Press EXT to exit.

1.3 Buzzer Setup

Pressing ENT to enter the main menu, use UP or DN to select system menu, press ENT to enter System menu. Use UP or DN to select Buzzer, press ENT to enter the buzzer interface.

- (1) [SYSTEM/BUZZE/STATE] Buzzer ON/OFF: Press ENT button to enter the main menu, press ENT again while "SYSTEM" is flashing. Use UP and DN until flashing "BUZZE" is displayed and press ENT. When "STATE" is shown, press R or L to toggle between ON and OFF settings. Press ENT to confirm and EXT to exit.

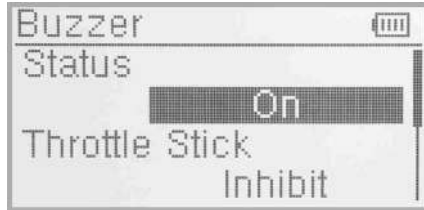

- (2) [SYSTEM/BUZZE/THSTK] Throttle stick: under the Buzzer setting menu the option THSTK can be set to ON or OFF. If the Throttle Stick setting is ON/Active, a musical scale will be heard when moving the throttle stick. The position of the throttle stick can be judged by listening to the change in musical tone. Setting OFF, turns off the sounds. After setting the [BUZZE\STATE] setting, press DN until THSTK is displayed. The current status is displayed, press R or L to change the display between INH and ACT. ACT means tones will be played, INH means there will be no tones played.

- (3) [SYSTEM/BUZZE/TONE] Buzzer tone: the buzzer tone can be selected from 10 notes. You can set the tone according to your preference. After setting the "THSTK", press DN until "TONE" is displayed. Use R or L key to change the flashing value between 1 and 10. Press EXT button to exit when finished.

1.4 Vibrator Setup

The DEVO 7E can set Vibrator as an alarm function.

Setup: Press ENT to the Main Menu, use UP or DN to select System Menu. And then press ENT to get the System Menu, use UP or DN to select Vibrator. Press ENT to get Vibrator setup interface. There are Inhibit and Active two status. Press R or L to select Active for Vibrator function. Press EXT to exit after finished.

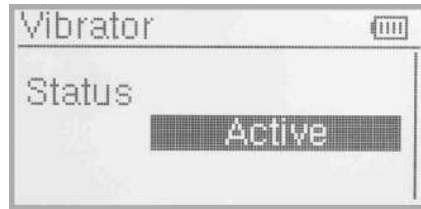

1.5 Stick Mode Setup

There are 4 stick modes including MODE1, MODE2, MODE3 and MODE4. Right-hand throttle includes MODE1 and MODE3; while left-hand throttle includes MODE2 and MODE4. See below setup:

[SYSTEM/STMOD] Stick Mode: from the SYSTEM menu, press UP or DN until flashing "STMOD" is displayed, press ENT again to enter the stick mode selection sub-menu. Use R or L to select the required stick mode. Press ENT to confirm the flashing value and EXT to exit to the main menu.

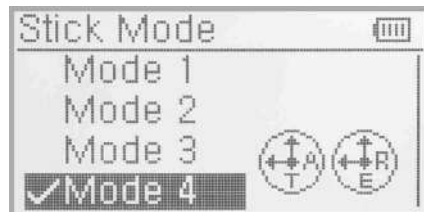
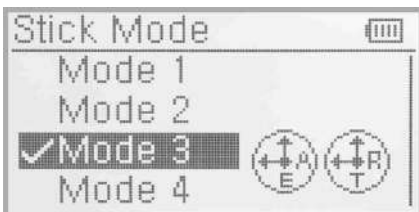
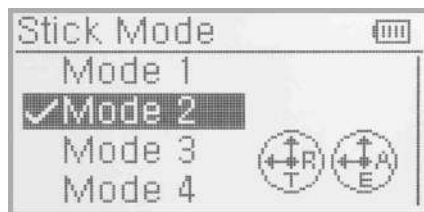

Please refer to 8.0 Switches exchange between left-hand and right-hand throttles. Press EXT to exit after finished.

1.6 Stick Direction

Press ENT to enter into Main Menu; Press UP or DN to make navigation mark at System menu. Press ENT to enter into System menu; Press UP or DN to choose Stick direction, press ENT to enter into Stick direction interface.

Stick Direction: There are four items available as Elevator, Aileron, Throttle and Rudder. Press UP or DN to select the stick which will change direction, and press R or L to change the direction. The factory setting is Normal.

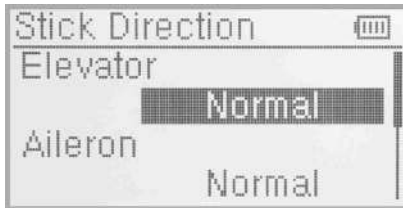

1.7 Stick Calibration

The stick calibration used to re-calibration when stick unusual.

Enter the System Menu, use UP or DN to select Stick Calibration and press ENT to the Stick Calibration setup interface. Press ENT to enter Calibration, the display will be as shown below:

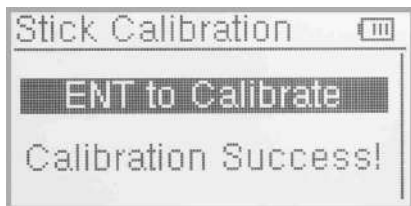
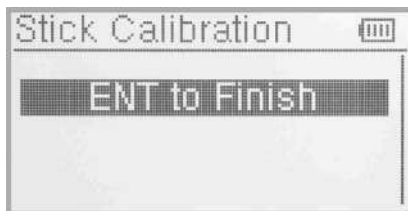
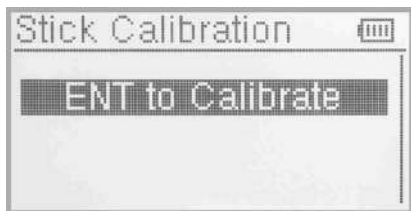

Stick calibration: Move all of the control sticks to their maximum and minimum levels several times, when complete, return the sticks to their neutral positions.

Press ENT again to STOP the calibration process and the display should show "START: SUCCESS".

If the display shows "STOP:ERROR", the calibration has failed. Please go back to the STMOD sub-menu using EXT and re-start the calibration process.

Press EXT to exit after finished.

1.8 About

From the SYSTEM menu, use UP or DN to choose About and press ENT to enter About interface. The firmware and Library version will be displayed.

Press EXT to exit when finished.

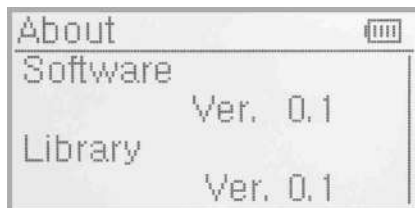

2.0 Model Menu

Model Menu manages all the model data saved in DEVO 7E. It includes Model Select, Model Name, Model Copy, Model Transmit, Model Receive, Model Reset, Type Select, Trim System, Stick Position Switch, Device Select, Device Output, Swash Type, Fixed ID and Sensor setting.

2.1 Model Selection

Press ENT to get Main Menu and press UP or DN to select Model Menu. Press ENT to get the Model Menu and press UP or DN to select Model select, press ENT to get the Model Select setup interface.

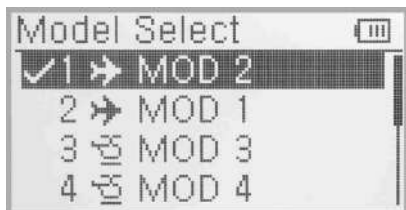

Press UP or DN until the desired model starts to flash. A total of 30 model configurations can be stored. Press ENT to confirm then EXT to exit

2.2 Model Name

In the model name menu, you can edit the model name to 8 characters of your own choosing to simplify configuration selection next flight session. First, follow step "2.1 Model Selection" to choose the model you want to rename or edit.

Press ENT to enter the Main Menu, use UP and DN to select MODEL, press ENT to enter Model sub-menu, press UP or DN until "NAME" is in the display. Press ENT again to display the serial No. (1~30) and current name. Use UP and DN to select the characters to be changed, use R or L to change the selected character.



Press ENT then EXT to finish.

2.3 Model Copy

Press ENT to enter the Main Menu, use UP and DN to select MODEL Menu, press ENT to enter Model submenu, press UP or DN until " Model COPY" is in the display. Press ENT again to select the source Model. Use R and L to change the selected model.

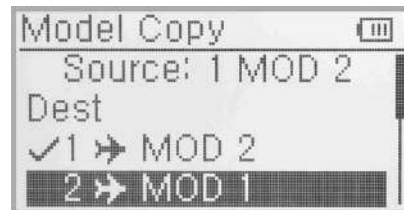
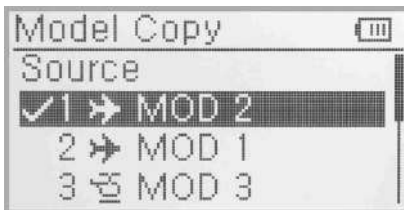

Press ENT to confirm the destination model into which to copy the current settings. " Are you sure?" will be displayed as below illustration, Press ENT to confirm the copy or EXT to exit.

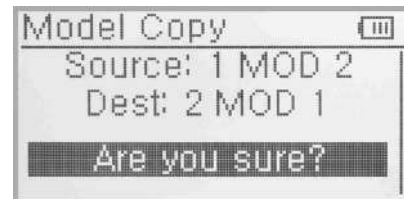

2.4 Model wireless copy

Model data can be copied wirelessly between two DEVO 7E units using the Model Transmit and Model Receive functions in the Model menu.

(1) Model Data transmission

Press ENT to enter the Main Menu, use UP and DN to select Model Menu, press ENT to enter Model sub-menu, press UP or DN until " Model Transmit " is in the display. Press ENT again and use R and L to choose the source model which will be transmitted.

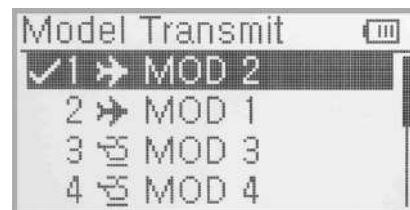

Press ENT again to confirm ,an enquiry "Are you sure?" will be shown as below illustration, Press ENT to transmit, "Transmitting" appears in the interface. Or press EXT to exit. Press EXT to exit after another DEVO 7E received the data.

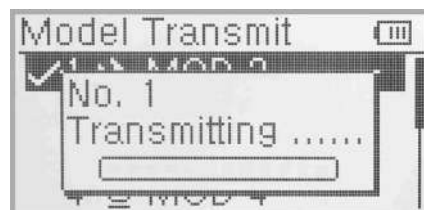
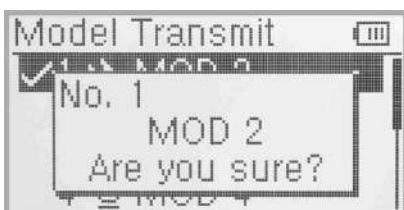

(2) Model Receive

To receive model data, first select the model into which data should be copied, follow the process of model selection described previously. Model receive can overwrite an existing configuration so be sure to select carefully. Press ENT to enter the Main Menu, use UP and DN to select Model Menu, press ENT to enter Model submenu, press UP or DN until Model Receiving is in the display. Press ENT again to confirm. An enquiry information "Are you sure?" will be shown as below Illustration, press ENT to confirm the reception, press EXT to exit.

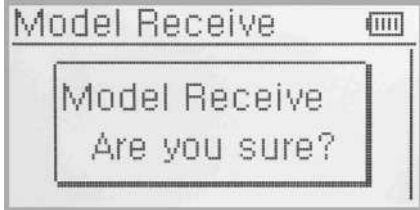

After pressing ENT to receive, the display shows "Connecting" in the interface. The information of "Received" with the model name will be shown after receiving is finished. Or press EXT to exit.

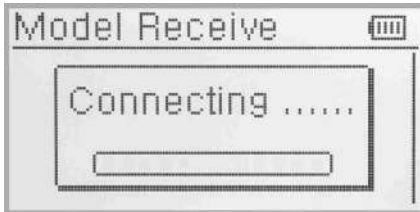

Press UP or DN to choose the save position, an enquiry information "Are you sure?" is shown after press ENT. Press ENT to save or press EXT to exit.

After saving is complete the system will return to the main menu.

Press EXT to exit after finished.

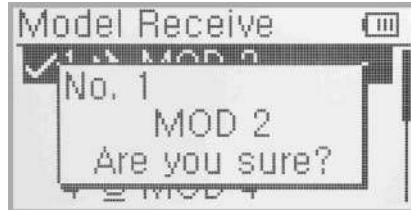

2.5 Model reset

Using the Model Reset function the settings for one or all models can be reset to the factory defaults.

It is possible to store up to 30 models data in the model list of DEVO 7E equipment. There are two methods to reset the model data: batch reset and single reset. Here is the setup:

Press ENT to enter the Main Menu, use UP and DN to select MODEL, press ENT to enter Model sub-menu, press UP or DN until "Model Reset" is in the display. Press ENT to get Model reset setting interface. Use R and L to select "ALL" for all models or the individual model name for a single model reset.

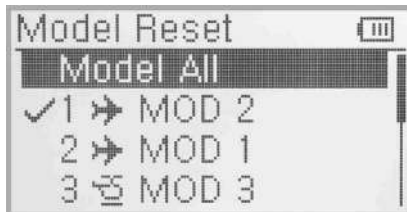

After selecting ALL or a specific model, press ENT, "Are you sure?" enquiry is displayed, press ENT to confirm or EXT to cancel.

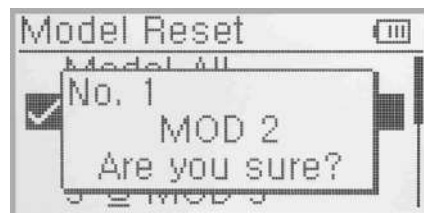
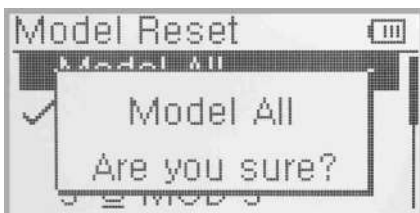

Press EXT to exit after finished.

2.6 Type Select

This transmitter offers a choice of two model types. The options are helicopter and airplane.

Press ENT to Main Menu, press UP or DN to select Model Menu. Press ENT to enter and press UP or DN to select Type Select and press ENT to enter Type select interface. Use UP or DN to select Helicopter or Airplane, press ENT to confirm, then press EXT to exit.



2.7 Trim System

The Trim System permits the user to fine tune the following items: Elevator, Aileron, Rudder, Throttle. The trim step is divided in to 20 (factory default is 4). Using small values, permits fine trim control, larger values make larger adjustments for each 'click' of trim, the procedure to adjust the trim step is as follows:

Press ENT to get Main Menu and press UP or DN to select Model Menu. Press ENT to enter and press UP or DN to select Trim System, press ENT to enter setting interface. Use UP or DN to select Elevator,Aileron,Rudder and Throttle. Use R or L to change the step value.Press ENT to confirm and EXT to exit.

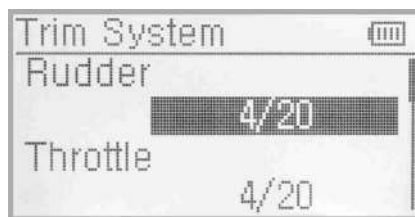
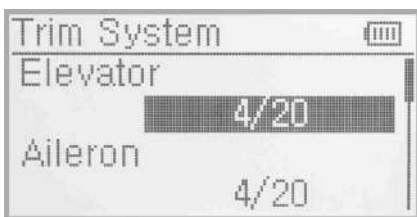

Press UP or DN to select the trim which will set, press R to increase the trim value and press L to decrease. For elevator, aileron and rudder, there are two more options : Normal and Limited. Press R or L you can change the setup. " Normal: means the trim is always working although th corresponding stick stays anywhere. " Limited" means the trim is out of working when the corresponding stick is at maximum position.

The last 3 settings in this menu determine if the trim is applied at full control stick or not. This can prevent servo binding at maximum extents. When "NORM" is displayed, the trim setting is always applied, even at 100% travel. "LIMIT" setting, means that the trim is not applied when the control stick is a full travel. Default is "NORM". Press ENT to confirm, EXT to exit.

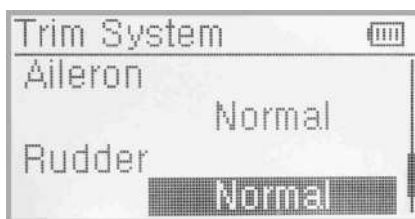
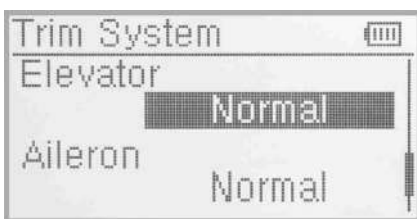

Press EXT to exit after finished.

2.8 Stick Position Switch

The Stick position switch can be used as turn-on or turn-off switches

Setup:

Press the ENT to get Main Menu and press UP or DN to select Model Menu. Press ENT to get Model Menu and press UP or DN to select Stick Position Switch, press ENT to get Stick Position Switch setting interface.

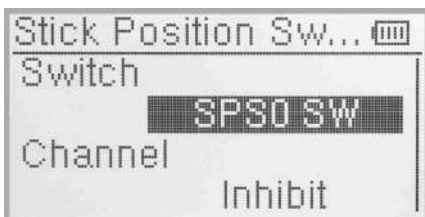

There are four options under the Stick position switch: SPS0, SPS1,SPS2,SPS3. Press R or L to choose the switch you want to define.

Press UP or DN to inhibit channel in navigation mark, and press R to expand the menu. The channel includes four items: Elevator, Aileron, Throttle and Rudder. The factory default is Inhibit. Take Elevator for example.

Press R or L to choose the Elevator as stick, then Press DN to move navigation mark to value of position. It's possible to adjust the stick position via pressing R or L.

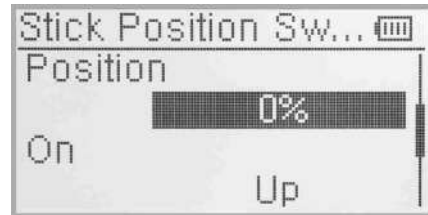

Press DN to navigate the OPEN setting, press R or L to change the direction of the channel stick.

Press UP or DN to navigate the STATUS, which can check the sketch map of the stick OPEN/CLOSE direction. Check if it was set correctly.

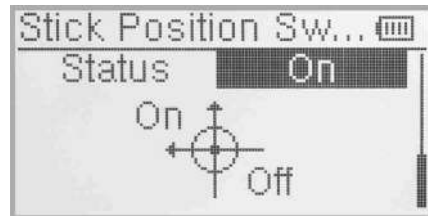
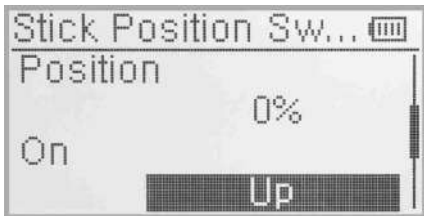

After finished the setting, press EXT to exit.

2.9 Device select

This setting can help you configure various functional switches. It includes Flight Mode switch, Flight Mode trim, Throttle hold Switch and Flap Switch select.

Press ENT to enter Main Menu, press UP or DN to move navigation mark to select Model menu. Press ENT to enter Model menu function. Press UP or DN to select Device Option. Press ENT to Device Option interface.

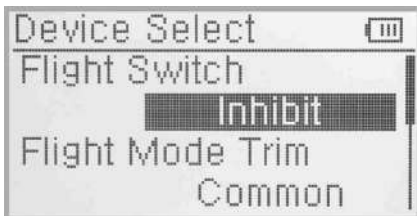

(1) Flight Mode Switch

Press UP or DN to move navigation mark to Flight Mode Switch and press R or L to select the desired switch, there are both FMOD SW, HOLD SW and Inhibit. The factory default setting is Inhibit.

(2) Flight Mode Trim

There are two option modes: Common and Flight Mode. In Common Mode, all the trim values settings are applied the same to each Flight Mode. In Flight Mode, the trim value can be set and remembered differently for each of the 3 available Flight Modes. The default is common.

Setup:

Press UP or DN to choose the Stunt trim select, press R or L to select "Common" or Flight Mode, the factory default setting is Common.

(3) Throttle Hold Switch

Refer to (1) Flight Mode Switch.

(4) Flap Switch Select

Refer to (1) Flight Mode Switch.

After finished the setting, press EXT to exit.

2.10 Device Output

Device output can set up the output switches respectively. It can also activate, inhibit or use other functions. There are FMODE switch, Hold switch, SPSO, SPS1, SPS2, SPS3.

Press ENT to enter Main Menu, press UP or DN to move navigational mark to Model Menu. Press ENT to enter Model menu. Press UP or DN to select Output device and press ENT to enter Output device interface.

Below three items can be adjusted: Gear, Flap, AUX2.

(1) Gear



Press UP or DN in output interface can change the gear switch. It includes FMODE SW, HOLD SW, SPSO, SPS1, SPS2, SPS3. Press R or L to select the setting switch, the default setting is HOLD SW.

Press UP or DN to select Function setting after you select the switch, Press R or L enter the interface of Gear active, inhibit, Gyro and Governor. The default setting is Active. You can continue to set other items after finished.

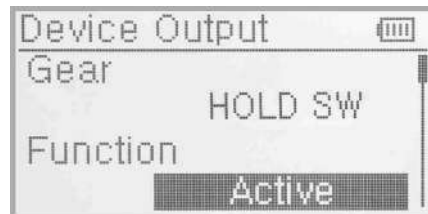

(2) Flap

Press UP or DN to move navigation marks to Function setting below Flap. The factory default setting is System Output setting.

It's possible to change via pressing L to show Flap Output setting.

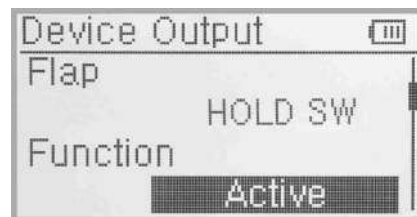
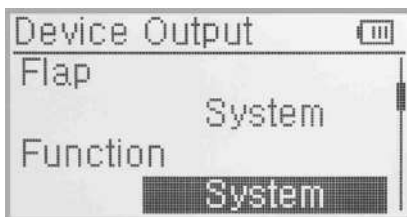

Press UP or DN to move navigational mark to Flap. Press R or L to expand the menu including FMODE SW, HOLD SW, SPSO, SPS1, SPS2, SPS3. The default setting is HOLD SW.

Press UP or DN to move navigational mark to Function setting. Press R or L to select the items you want to set up. And the items includes Inhibit, Active and System. Continue to set up other items after setting finished.



(3) AUX 2

Press UP or DN to enter the AUX2 interface. Press R or L can change the AUX2 switch. It includes FMODE SW, HOLD SW, SPSO, SPS1, SPS2, SPS3 The default setting is FMODE switch.

Press UP or DN to select the Function setting, press R or L to choose the switch, it includes inhibit, active, Gyro, Governor, the default setting is Gyro. After finishing the setting, press EXT to exit .

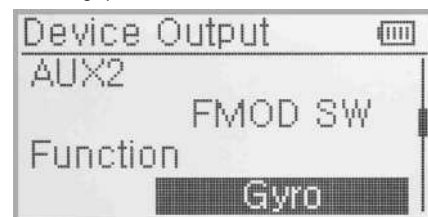
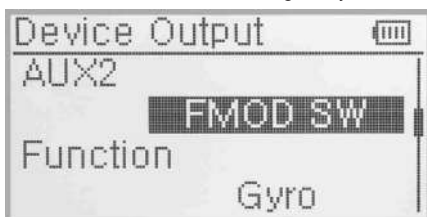

2.11 Wing Type

Wing Type is grouped into Normal, Flaperon, Delta and V-Tail.

Wing Type selection:

Press ENT to enter Main Menu, press UP or DN to move navigation mark to Model Menu. Press ENT to enter Model Menu. Press UP or DN to choose Wing Type, and press ENT to enter the Wing Type interface. Press UP or DN to move navigation mark to Wing Type. Press R or L to choose Wing Type. The Wing Type are Normal, Flaperon and Delta.

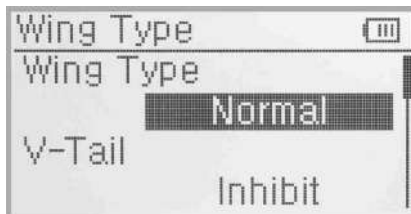

(1) Flaperon

Press R or L to choose Flaperon under Wing Type.

Below is the sketch map of Flaperon servos' assignment:

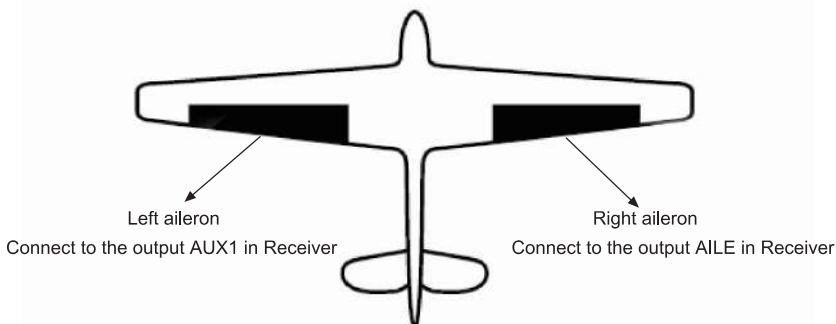

(2) Delta

Press R or L to choose Delta in Wing Type.

Below is the sketch map of Delta servos' assignment:

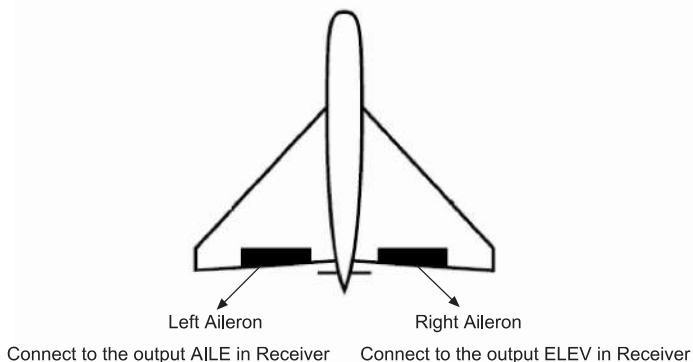

(3) V-tail

Press UP or DN to move navigation mark to V-TAIL under V-Tail interface. There are Inhibit and Active, please choose Active. V-tail is unadjustable when the Wing type is DELTA.

Below is the sketch map of servos' assignment in V-tail:

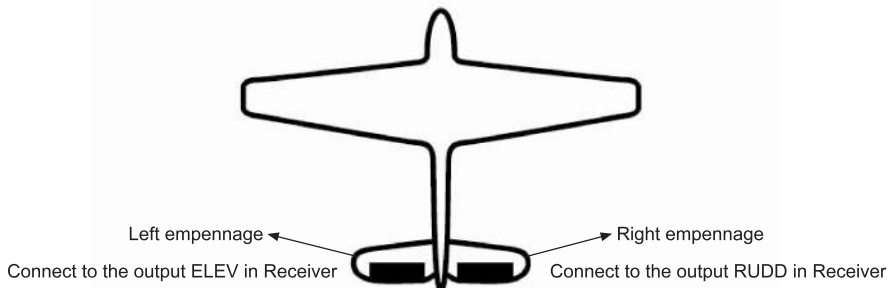

(4) Dual channels setup

Dual Channels can be set as Elevator, Aileron, Rudder, or Flaperon. It is of dual channel output function. The channel, which will be set as dual channel at AUX in Device Output (Refer to “2.10 Device Output”), should be previously set as Inhibit when the AUX channel is being set.

Setting method:

Channel setup: Press UP or DN to move the navigational mark to item Dual Channels in the interface of Wing Type. Pressing R or L, there are items of Elevator, Aileron, Rudder, and Flap. We take Elevator as an example.



(4.1) Mate setup: Press UP or DN to move navigational mark to “Mate Channels”, press R or L to select the desired channel in the menu with Inhibit and the inhibited channels previously set in “Device Output”.



The settings of Aileron, Rudder and Flap in the item Channel are same as above.

(5) Twin Engine

This function can be set as twin engine output to meet the requirement for the models, which are powered by twin engines.

(5.1) Mate setup: Press UP or DN to select “Twin Engine” setting, press R or L to choose the desired channel in the menu with Inhibit and the inhibited channels previously set in “Device Output”.

Press EXT after setting finished.

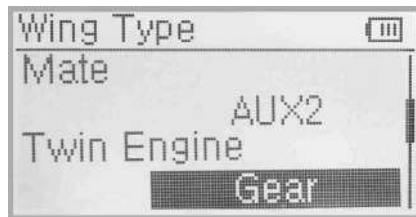

2.12 Fixed ID

Using the Fixed ID function allows users to create a unique relationship between transmitter model data and the corresponding model's receiver. It significantly speeds up the binding process and also prevents mistakenly flying an aircraft with the incorrect transmitter model selected.

(1) Fixed ID setup

To start the Fixed ID setup it is important that the transmitter and receiver have successfully completed automatic ID binding process. Once the transmitter and receiver are paired a Fixed ID can be set as described below.

Press the "ENT" button on the main panel and a flashing System will display in the LCD. Use UP or DN to cycle through the options until Model menu appears flashing. Press "ENT" again to enter into Model edit menu. Press UP or DN until a flashing "FIXID" is displayed, press "ENT" to enter the Fixed ID menu. The current status is displayed. Use R or L to toggle between modes and set to "ON". Press DN to confirm and enter the Fixed ID code setting screen.

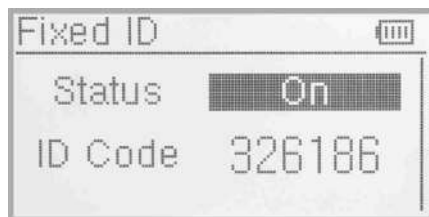
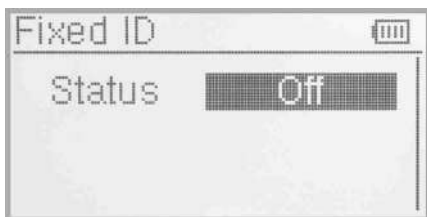

Press ENT to change the code data, use R and L to change the code values, press DN to move to the next digit, UP to move to the previous digit. There are 6 digits can be settled. After setting the desired code press ENT, "RUN" will be displayed. Use R or L to change NO to YES and press ENT to confirm and execute the binding process. An inquiry interface of "Are you sure?" pop up. "ID Code Matching ..." will be shown after press ENT. After binding the display will return to the model menu automatically.

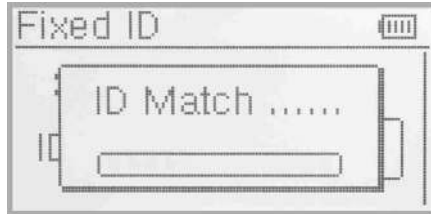
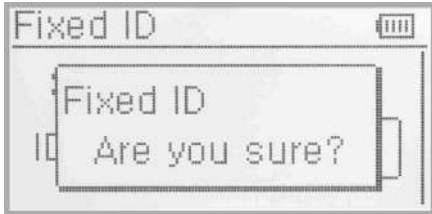

(2) Cancelling/Resetting the Fixed ID

If you wish to change the receiver Fixed ID model back to random ID, insert the included BIND PLUG into the output terminal BATT before the receiver is powered on. Connect 5V DC power to the Throttle channel. The red LED of the receiver will flash slowly. Remove the BIND PLUG. The Fixed ID code has been cancelled. After the receiver's Fixed ID is reset it should also be reset in the Transmitter. Here is the setup:

In the main interface press the ENT to enter Model Menu and then press UP or DN to move the navigational mark to select MODEL MENU. Press ENT to enter MODEL MENU. Press UP or DN to select Fixed ID code and press ENT key to enter the Fixed ID code interface. Press UP or DN to select STATUS option, Press R or L to change the status to Off. Then press EXT to exit.



2.13 Sensor Setup

Setting method: press ENT enter to the Main Menu. Press UP or DN to select the Model Menu. Press ENT enter to Model Menu. Press UP or DN to select sensor press ENT enter to the sensor setting interface. See the Illustration.



Press R or L to select Activate or Inhibit (the default setting is Inhibit), such as press Activate will includes No Signal Warning, Voltage sensor, Temperature sensor, GPS receiver setting etc.

(1) No Signal Warning

Press UP or DN to make the navigation mark to choose "No Signal Warning". Press R or L to choose "Inhibit" or "Active" (default setting is "inhibit"). If you choose "Active", the Radio will alarm when telemetry signal lost. As following:



(2) Voltage Setup

There are 3 different types of voltage can be measured. It includes Internal 5V, External V1 and V2 which can be monitored two different external voltage (i.e. battery) respectively. Once the measured voltage is lower than the setting value, the Radio will alarm.

(2.1) Receiver 5V (Internal) PFV (Power Feeding Voltage) Alarmed value can be set as 3.6-6V

Voltage Setup: press R or L to activate the 5V, the alarm interface will appear in the interface, please refer to the Illustration.



Press UP or DN to select the Alarm Voltage setting, press R or L to set the value. The range is 3.6-6V, you can continue to set other items after you finished.

(2.2) External V1

Press UP or DN enter to External V1 setting interface. Press R or L to activate the V1, the details refers to the Illustration.



Press UP or DN to select the Alarm Voltage setting. Press R or L to set the value. The setting range is 0.2~99.9V. You can continue to set other items after you finished.

(2.3) External: V2 setting can refer to External V1 setting.

Press EXT back to sensor setting interface after you finished.

(3) Temperature sensor

The temperature sensor can measure up to 4 different temperature(i.e.motors).You can choose Celsius or Fahrenheit.The alarmed value can be setted to 4 different temperature.Once the measured value is higher than the setting value,the radio will alarm.The Alarm Temperature value can be setted as -20~220° C or -4.0~428.0° F.

Temperature Setup:

In the "Sensor Setting" interface,press UP or DN to make the navigation mark to choose "Temperature Sensor", and press ENT to enter "Temperature Sensor" setting interface. See the illustration.



(3.1) Unit

Press UP or DN to make the navigation mark to choose "Unit" setting item, and press R or L to choose Unit, two kinds of Unit:Celsius and Fahrenheit.

(3.2) Alarm Temperature Setup

Press UP or DN select the T1, Press R or L to activate the setting.Inhibit will change to Active and Alarm temperature will be shown. If you choose Inhibit, the Alarm temperature value won't be shown.

Press UP or DN to select "Alarm" setting, press R or L to set the alarm temperature value. Press UP or DN to set other items after finishing the setting.



(3.3) T2, T3, T4 Setup

Refer to the step of "(3.2)T1".

(4) GPS Setup

There are 4 items including Altitude Type,Speed Unit, Date Type and Time Zone in the GPS receiver setting interface. Press UP or DN to select the Sensor setting interface to enter the GPS setting interface.



(4.1) Altitude Type

Press UP or DN to select the Altitude type on the GPS setting interface and it's Absolute and Relative.

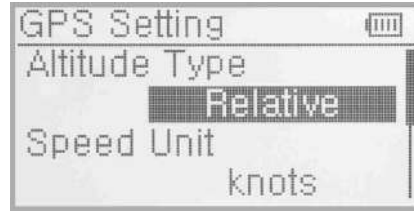

(4.2) Speed Unit

Press UP or DN to select the Speed Unit on the GPS setting interface and it includes knots and km/h and relative. Select the desired item.



(4.3) Date Type

Press UP or DN to select the Date Type on the GPS setting interface and it includes DD-MM-YY, MM-DD-YY and YY-MM-DD. Select the desired item.

(4.4) Time Zone

Press UP or DN to select the Time Zone , press R or L to set the desired Time Zone.



(4.3) Date Type



(4.4) Time Zone

3.0 Function Menu

Function Menu can help you custom adjustments for the selected models. The menu includes such items as Reverse Switch, Travel Adjust, Sub Trim, Dual Rate and Exponential, Throttle Hold, Throttle Curve, Differential, Balance, Gyro Sensor, Governor, Aileron to Rudder Mix, Elevator to Flap Mix, Rudder to Aileron/Elevator Mix, Flap System, Aileron to Flap Mix, Program Mix, Monitor, Fail Safe, Sensor view, Trainer and Timer.

3.1 Reverse Switch

Press ENT in main interface to enter main menu; Press UP or DN to move the navigation mark to Function Menu. And press ENT to enter Function Menu, Press UP or DN to choose Reverse Switch and Press ENT to enter into Reverse Switch interface.

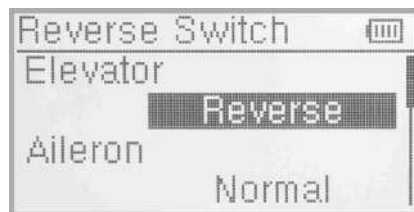
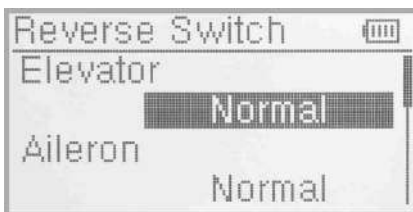

Press UP or DN to move navigation mark to ELEV (take Elevator for example), Press R or L to shift the status between normal and reverse. These are two status options. And the default setting is Normal. All Channels Reverse Switch like: Aileron, Throttle, Rudder, Gear, Flap, Gyro can be referred to the way of ELE Reverse Switch. And press EXT to exit after finishing setting.

3.2 Travel Adjust

Press ENT to enter into main menu. Press UP or DN to move navigation mark to select item Function menu. Press ENT to enter Function Menu. Press UP or DN to select Travel Ajust, Press ENT to enter Travel Adjust interface, as below illustration. It shows the Travel Adjust status of one channel:

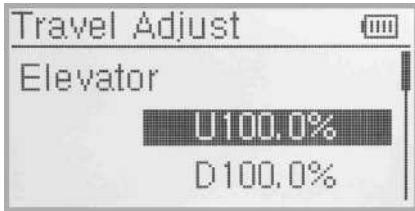

Take ELEV for example, Press UP or DN to move navigation to desired item Elevation of U. Press R or L to increase or decrease the servo travel range. The adjustment range is from 0.0% to 150.0%. The factory default is 100.0%.

Press UP or DN to move navigation mark to desired item D of ELEV. Press R or L to increase or decrease the servo travel range. The range is from 0.0% to 150.0%. The factory default is 100.0%.

All other channel's Travel Adjust like Aileron, Throttle, Rudder, Gear, Flap, Gyro can be referred to ELEV travel Ajust. Press EXT to exit after setting finished.

3.3 Sub Trim

Sub Trim is used to fine tune the servo neutral position during setup. In order to avoid pushing the servo beyond it's limits and possibly causing damage it is advised to first mechanically adjust the servo arm/bell crank to be as close to the neutral point as possible. Only when this is complete may sub trim be used to make a final adjustment

Setup:

Press ENT to enter Main Menu, Press UP or DN to move the navigation mark to desired item Function menu. Press ENT to enter Function menu, Press UP or DN to select Sub trim, and press ENT to enter Sub Trim interface.

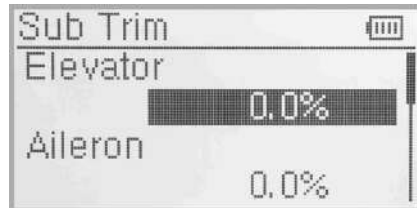

The interface shows the items and the channels which are adjustable. Press R or L to change the neutral point of Servos. The default for every channel is 0.0%. The permitted adjustment ranges are show in the table below:

Channel name	Adjustment range	Channel name	Adjustment range
Elevator	D62.5% ~ U62.5%	Gear	-62.5% ~ +62.5%
Aileron	R62.5% ~ L62.5%	Flap	D62.5% ~ U62.5%
Throttle	L62.5% ~ H62.5%	Gyro	-62.5% ~ +62.5%
Rudder	R62.5% ~ L62.5%		

Press EXT to exit after adjustment finished.

3.4 Dual rate and Exponential

Dual Rate/Exponential is a function which permits a change in behavior of the control sticks between pre-defined settings. Dual Rate alters the maximum and minimum servo travel available, Expo has no effect on the maximum or minimum travel but decreases or increases the sensitivity to stick movement in an exponential manner. One use of Dual Rate/Expo is to reduce the sensitivity of the controls when landing.

Setting method

Press ENT to enter main menu. Press UP or DN to move navigation mark to desired item Function Menu. Press ENT to enter Function menu, press UP or DN to choose Dual rate and Exponential, Press ENT to enter D/R and Exponential interface.

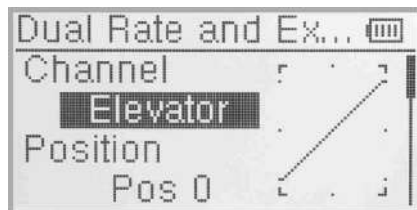

(1) Channel selection

Press UP or DN to move navigation mark of Channel, Press R or L to set up channels containing Elevator, Aileron and Rudder. Choose the desired channel for setting.

(2) Position selection

Press UP or DN to move navigation mark to desired item Position. In the manual mode, the function of Dual rate and Exponential will be executed by the corresponding FMODE switch among Pos0 and Pos1. Take the item Elevator at channel as an example, It's possible to shift between Pos0 and Pos 1 via pushing or pulling the FMODE switch.

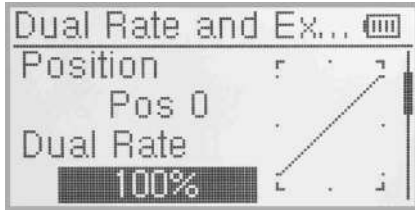

(3) Dual rate adjustment

Press UP or DN to move the navigation mark to desired item Dual Rate. It's possible to change the dual rate value of Position via pressing R or L and the corresponding value curve in the right top of interface will be changed accordingly. The factory default is 100%.

(4) Exponential

Press UP or DN to select Exponential item of navigation mark. It's possible to change Dual Rate and Exponential value in Pos when pressing R or L to change the value. There are ± 100% and Line three adjustment. At the same time, the corresponding curve will be changed and shown at the right graph.

(5) Flight Mode 0

Press DN to move the navigation mark to Flight Mode 0, press R or L to choose Pos0 and Pos1.

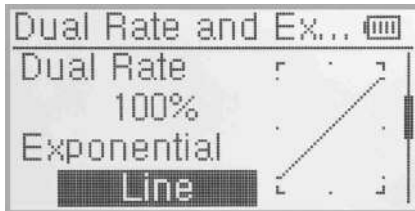

(4) Exponential

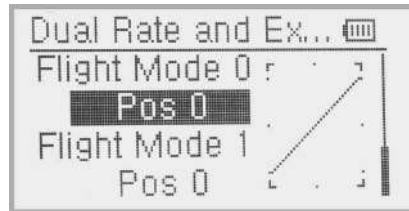

(5) Flight Mode 0

(6) Flight Mode 1: Refer to "(5) Flight Mode 0"

Press EXT to exit after finishing the setting.

3.5 Throttle Hold

If the throttle hold function is activated in the function settings menu, it can be operated by the Throttle Hold switch as shown in the picture below. The permitted setting range is from -20.0% to 50.0%. The default setting is inhibited.

Press ENT to enter main menu, Press UP or DN to move navigation mark to select Function menu. Press ENT to enter Function Menu. Press UP or DN to select Throttle Hold, Press ENT to enter Throttle Hold interface, as below illustration:



Press R or L to activate Throttle Hold function, and expansion list will be shown as Throttle hold status, throttle hold position and Throttle hold switch.

(1) There are two items under Throttle Hold Status: Active and Inhibit. The factory default setting is Inhibit.

(2) Throttle Hold position

In the Throttle Hold interface, press UP or DN to make the Navigation mark choose "Throttle Hold Position" setting options. Press R or L to change data, the minimum value is -20.0%; the maximum value is +50.0%.

(3) Throttle Switch setting

It's invalid for setting, the factory default is HOLD switch which will be shown in the status item. When the Throttle Hold switch is ON, data under the Throttle Hold can not be amended until Throttle Hold switch to be OFF, and the hold status is changed.

Press EXT to exit after setting up finished.

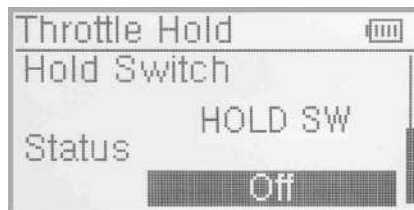

3.6 Throttle Curve

Throttle Curve are adjusted through 7 points.

Setting method:

Press ENT to enter main menu, Press UP or DN to move navigation mark to select Function Menu. Press ENT to enter Function Menu. Press UP or DN to select Throttle Curve, Press ENT to enter Throttle Curve interface. The enquiry dropdown is shown "All servos hold?" If click OK, all the servos will be locked at the current status, if click Cancel, all the servos will be unlocked at the current status.

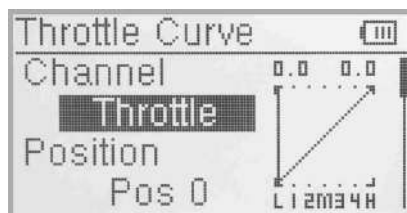
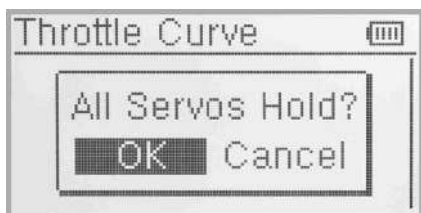

(1) Channel setting

The default setting is Throttle Channel, and can not reset.

(2) Position selection

Press UP or DN in the "Throttle Curve" setting interface to select "Position", press R or L to select the item you want to set in the list with Pos 0 and Pos 1.

(3) Exponential Adjustment

Press UP or DN in Throttle Curve interface to move navigation mark of exponential curve and press R or L to set the exponential function Off and On. The throttle curve will be changed smoothly if touching ON, or in fold line if clicking OFF.

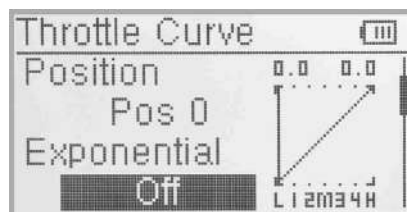

(4) Curve setting

It includes two items: Point and Output.

(4.1) Point setting

Press UP or DN in Throttle Curve interface to select Points setting. Press L to expand a list including seven points: "Point-L", "Point-1", "Point-2", "Point-M", "Point-3", "Point-4" and "Point-H". Press R or L to select the point you want to adjust.

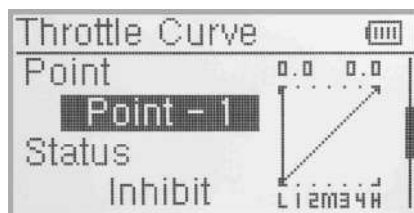
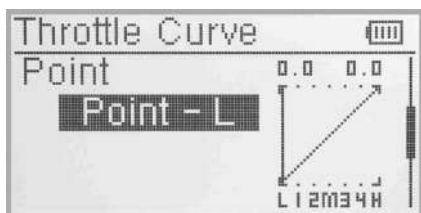

(4.2) Status setting

After above setup, press UP or DN to select Status setting, press R or L to set Inhibit and Active. Select Inhibit if for keeping the current value (the default setting is Inhibit). Select Active for changing the above points' value.

(4.3) Output setting

An expansion list of Output items will be shown after activating the Status. Press UP or DN to move navigation mark to select Output item. And press R or L to increase or decrease the amount of selected point with a minimum of 0.0% and a maximum of 100.0%. The curve graph in right will be change accordingly.

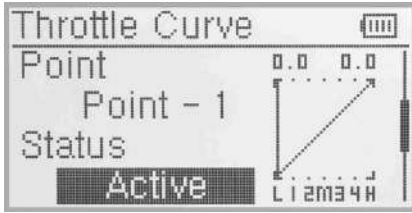

(4.2) Status setting

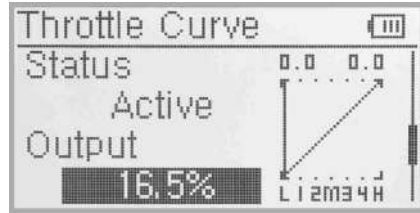

(4.3) Output setting

(4.4) Throttle setting

The switch between Pos 0 and Pos 1 can be freely realized through throttle stick after the below amount has been set up. The below set amount is the position of throttle stick as well as the switch point.

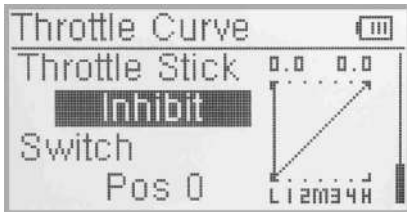

Throttle setting: Press UP or DN to select Throttle setting, Press L to decrease the amount with a lower limit of 0.0% or Inhibit, Press R to increase the amount with an upper limit of 100.0%.

(4.5) Switch Selection

When the item Throttle Stick is set in Inhibit, it is possible to switch between Pos 0 and Pos 1 by Switch. Press UP or DN to select "Switch". Press ENT to enter into Switch selection interface, press UP or DN to choose desired item. Press ENT, the desired item whose left side will be changed into "1" from "0". If two or more items are selected, the item should be chosen, whose left side should be changed into "1" from "0". Press EXT after finished it.

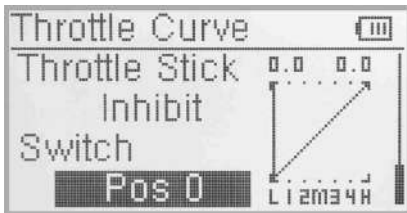

3.7 Differential

If want to use this function, Flaperon or Delta should be previously selected in Wing Type of Model Menu. Refer to "2.11 Wing Type".

(1) Aileron differential setting

Press ENT to enter into Main menu; press UP or DN to choose Function menu. Press ENT to enter into Function menu; press UP or DN to choose Differential, press ENT to enter interface of Differential, illustration as below.

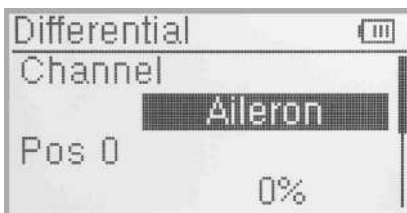

Mounting servos in left and right ailerons are a must if using this function. The following interface will be shown after Flaperon or DELTA selected in Wing Type. Refer to "2.11 Wing Type".

(1.1) Channel

Current setting channel is Aileron. System default can not be set.

(1.2) Setting for Pos 0

Press UP or DN to choose Pos 0, press R or L to increase or decrease differential value, respectively. The adjustable range is $\pm 100\%$.

(1.3) Setting for Pos 1

Press UP or DN to choose Pos1, press R or L to increase or decrease differential value, respectively. The adjustable range is $\pm 100\%$.

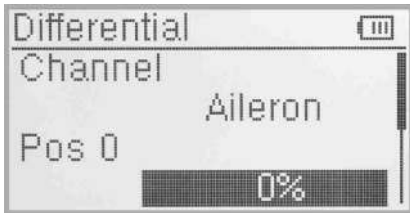

(1.2) Setting for Pos 0

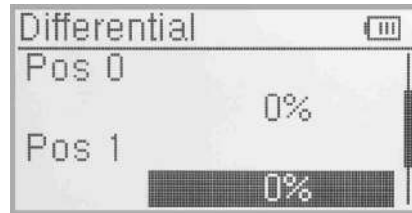

(1.3) Setting for Pos 1

(1.4) Switch selection

It is possible to switch by Setting Switch when differential is in use.

Press UP or DN to choose Switch, press ENT to enter interface of Switch selection, press UP or DN to choose desired item. Press ENT, the desired item whose left side will be changed into "1" from "0". If two or more items are selected, the item should be chosen, whose left side should be changed into "1" from "0". Press EXT after finished it.

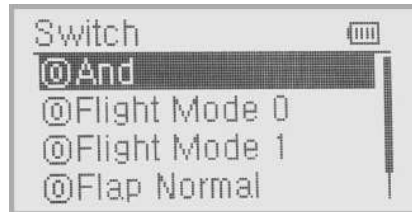
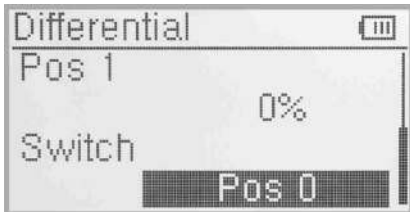

(2) Rudder differential setting

V-Tail should be previously set in Wing Type of Model Menu if the rudder differential function is activated. Refer to "2.11 Wing Type". And then the following interface will be shown:

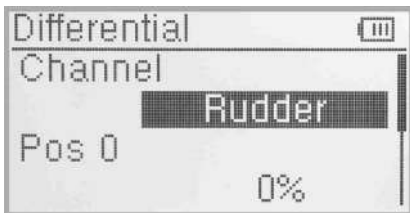

(2.1) Setting for Pos 0

Press UP or DN to choose Pos 0, press R or L to increase or decrease differential value, respectively. The adjustable range is $\pm 100\%$.

(2.2) Setting for Pos 1

Press UP or DN to choose Pos1, press R or L to increase or decrease differential value, respectively. The adjustable range is $\pm 100\%$.

(2.3) Switch selection

It is possible to switch by Setting Switch when differential is in use.

Press UP or DN to choose Switch, press ENT to enter interface of Switch selection, press UP or DN to choose desired item. Press ENT, the desired item whose left side will be changed into "1" from "0". If two or more items are selected, the item And should be chosen, whose left side should be changed into "1" from "0". Press EXT after finished it.



(3) Flap differential setting

It should be previously set the flap dual channel function in Wing Type of Model Menu (refer to “2.11 Wing Type”) in order to activate the menu of Flap Differential.

(3.1) Setting for Pos 0

Press UP or DN to choose Pos 0, press R or L to increase or decrease differential value, respectively. The adjustable range is ± 100%.



(3.2) Setting for Pos 1

Press UP or DN to choose Pos1, press R or L to increase or decrease differential value, respectively. The adjustable range is ± 100%.

(3.3) Switch selection

It is possible to switch by Setting Switch when differential is in use.

Press UP or DN to choose Switch, press ENT to enter interface of Switch selection, press UP or DN to choose desired item. Press ENT, the desired item whose left side will be changed into “1” from “0”. If two or more items are selected, the item should be chosen, whose left side should be changed into “1” from “0”. Press EXT after finished it.

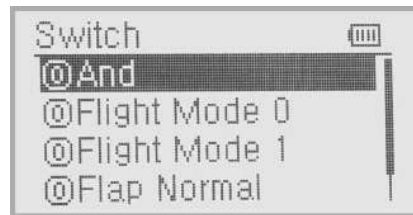
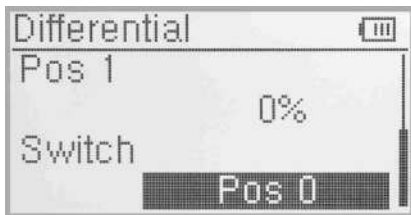

3.8 Balance

This function can adjust the parameters of the two servos which are used in the dual channels. It should be previously activated one of these wing types of Flaperon, Delta, and V Tail in Wing Type at Model Menu. Refer to “2.11 Wing Type”.

Setting method:

Press ENT to enter into Main Menu, press UP or DN to choose Function. Press ENT to enter into Function menu, press UP or DN to choose Balance. Press ENT to enter interface of Balance setting, picture as right:



(1) Channel: current setting channel is Aileron. System default can not be set.

(2) Point parameter adjustment

Point< Right Setting: Press UP or DN to choose “Point< Right”. If need to adjust the value, press L (0% means no adjusting). A minus value means the amending direction is downward; press R to adjust value(0% means no adjusting). A plus value means the amending direction is upward. The adjustable range is ± 100%.



Point-Right Setting: Press UP or DN to choose "Point-Right". Press R or L to inhibit or active. If need to adjust please active it. There will be expanded value adjustment item. Press UP or DN to choose "0%" If need to adjust the value, press L (0% means no adjusting). A minus value means the amending direction is downward; press R to adjust value (0% means no adjusting). A plus value means the amending direction is upward. The adjustable range is 100%.



Press UP or DN, there will be setting for Point-1, Point-2, Point-3, Point-Left, Point>Left, refer to the setting method as above. Press EXT after finished it.

3.9 Gyro sensor

This function offers the gain adjustment for gyro sensor, which can be manually set through HOLD switches or Flight mode switch, and also is possible to be automatically switched among various gains through flight mode switch. (The flight mode should be activated. Refer to "2.9 Device Select").

Setup:

Press ENT to enter Main menu; Press UP or DN to choose Function menu. Press ENT to enter Function menu; Press UP or DN to choose Gyro sensor, then press ENT to Gyro Sensor interface.

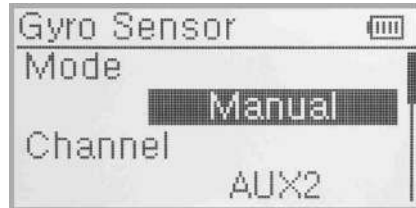

(1) Manual Setting

(1.1) Manual Setup: In the Gyro Sensor interface, here are Manual set and Automatic set for selectable choice. Press R or L to select Manual option. (Automatic setting can be activated if Flight mode is act, refer to "2.9 Device selection") . Choose "Manual Setup"

(1.2) Channel: The factory default channel is AUX 2. the Output set offer the function to change other control channels (refer to "2.10 Output").

(1.3) Switch Select: In the interface of Gyro Sensor, press UP or DN to choose SWITCH, there are FMODESW and HOLDSW for selectable sets, press R or L to choose the desired switch for Manual control.

(1.4) Sensitivity Setup: If the switch selection is two level, there are Position 0 and Position 1 two selection which can set the sensitivity individually.

(1.4.1) Status:turn the setting gyro control switch, the status items will display the current switch status position.

(1.4.2) Pos 0:Press UP or DN to move the navigational mark to Pos 0 and press R or L to increase or decrease, respectively, the value.If the gyro used has two modes of NOR and AVCS, NOR will be activated when the value is less than 50.0%. In NOR mode, the smaller the value is, the bigger the gyro sensor gain will be. The factory setting is 50.0%.



(1.4.3) "Pos 1" is the same setting way as above "Pos 0".



(2) Automatic setting

(2.1) Automatic Setup: in the Gyro Sensor interface,press UP or DN to choose Mode, there are Manual set and Automatic set for selectable choice. Press R or L to select Automatic option.

(2.2) Channel: The factory default channel is AUX2, the Output set offer the function to change other control channels (Refer to "2.10 Output").

(2.3) Switch:The switch function isn't available under Automatic setting.

(2.4) Status: turn the Flight Mode switch, the status display current flight mode position. There are "Flight Mode 0", "Flight Mode 1" etc.

(2.5) Flight Mode 0: Press UP or DN to select Flight Mode 0, press R/L can increase or decrease the value individually. If the gyro used has two modes of NOR and AVCS, NOR will be activated when the value is less than 50.0%. In NOR mode, the smaller the value is, the bigger the gyro sensor gain will be. The factory setting is 50.0%.



(2.6) Flight Mode 1 setting refer to "Flight Mode 0". After finishing the set, press EXT to exit.

3.10 Governor

To setup Governor, the Governor needs to be active under the Device Output menu (Refer to section 2.10 Device Output). The Governor function is a feature which, when enabled, automatically tries to maintain a constant main rotor speed.

It is possible to setup different Governor settings for each flight mode. On the transmitter, the display is a percentage for reference/adjustment, the actual rotation speed is set by the governor.

Setup:

Press ENT to Main menu in the interface, use UP or DN to choose function menu. Press ENT to function menu. Use UP or DN to choose Governor, then press ENT to the Governor setting interface, there are status and channels. Press UP or DN to "Flight Mode 0", "Flight Mode 1", and so on.



(1) Status

Toggle the Flight Mode, the status set display present flight mode position. There are "Flight Mode 0", "Flight Mode 1" and so on.

(2) Channel: The setted channels will display in "2.10 Device output" (Setup refer to 2.10 Device Output)

(3) Flight Mode 0

Press "UP/DN" to make the navigation choose the "Flight Mode 0" set, press R/L to increase/decrease the value. The factory default value is 0%, adjustable range $\pm 125\%$.

(4) "Flight Mode 1" setting refer to "Flight Mode 0".

After finished, press EXT to exit.

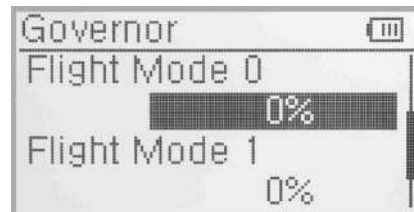

3.11 Aileron to Rudder Mix

This function is possible to execute the mix of aileron to rudder, which is controlled by switch.

Setting method:

Press ENT enter to Main menu, press UP or DN to select Function menu. Press ENT enter to Function menu. Press UP or DN select Aileron to rudder mix, press ENT to enter into Aileron to Rudder mix setting interface.

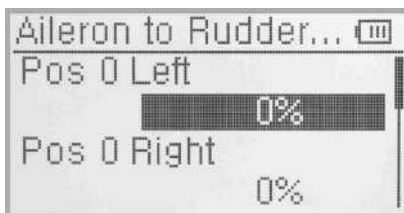

(1) Pos 0 Setting leftward setup

Press UP or DN select leftward mix value, press R or L, leftward mix value of aileron to rudder will be changed. The mix direction will be revised by changing the sign of plus or minus before the value. The adjustable range is $\pm 125\%$.

(2) Pos 0 Setting rightward setup

Press UP or DN to select rightward mix value, press R or L rightward mix value of aileron to rudder will be changed. The mix direction will be revised by changing the sign of plus or minus before the value. The adjustable range is $\pm 125\%$.

(3) Pos 1 setup, the setup is same as above.

(4) Throttle stick setup

The switch between Pos 0 and Pos 1 can be realized by setting the position of throttle stick. Press UP or DN of Throttle Stick to set the position amount of throttle stick. The default setting is Inhibit. The adjustable range is 0.0-100.0%.

(5) Switch setup

The switch will display the current switch position, press UP or DN to select the desired item press ENT to the setting interface and "0" before the item will be changed into "1". If two or more items are selected, the item And should be selected. Press EXT to exit after finished.



3.12 Elevator to flap mix

This function is used to execute the mix of elevator to flap.

Press ENT enter to main menu, press UP or DN to select function menu. Press ENT to enter to function menu. Press UP or DN to select Elevator to flap mix, press ENT to enter to Elevator to flap mix setting interface.

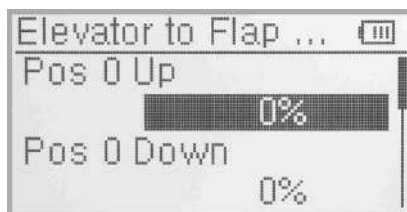

(1) Pos 0 UP setup

Press UP or DN to move the navigational mark to select item Pos 0 UP, press R or L upward mix value of Elevator to flap mix will be changed. The mix direction will be revised by changing the sign of plus or minus before the value. The adjustable range is $\pm 125\%$.

(2) Pos 0 Down setup

Press UP or DN to move the navigational mark to select item Pos 0 Down, press R or L downward mix value of Elevator to flap mix will be changed. The mix direction will be revised by changing the sign of plus or minus before the value. The adjustable range is $\pm 125\%$.

(3) Pos 1 setup, the setup is same as above.

(4) Throttle stick setup

The switch between Pos 0 and Pos 1 can be realized by setting the position of throttle stick. Press UP or DN of Throttle Stick to set the position amount of throttle stick. The default setting is Inhibit. The adjustable range is 0.0-100.0%.

(5) Switch setup

The switch will display the current switch position, Press UP or DN to select the desired item, press ENT to the setting interface and "0" before the item will be changed into "1". If two or more items are selected, the item And should be selected. Press EXT to exit after finished.

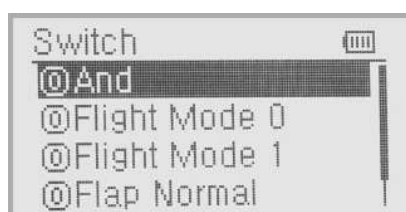

3.13 Rudder to aileron/elevator mix

This function is used to execute the mix of rudder to aileron/elevator. It will help eliminate waver or shake caused by rudder stick operation.

Setup:

Press ENT to enter Main Menu in the main interface, and press UP or DN to make the navigation mark to choose "Function Menu". Press ENT to enter "Function Menu", then press UP or DN to choose "Rudder to aileron/elevator mix" and press ENT to enter "Rudder to aileron/elevator mix" setting interface.

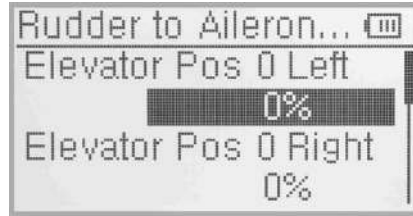

(1) Elevator setup

(1.1) Elevator Pos 0 Leftward Setup

Press UP or DN to make the navigation mark choose "Elevator Pos 0 Leftward setting" item, and press R or L to change the value and the Elevator mix amount when operating Rudder leftward. The mix direction will be revised by changing the sign of plus or minus before the value. The adjustable range is $\pm 125\%$.

(1.2) Elevator Pos 0 Rightward Setup

Press UP or DN to make the navigation mark choose "Elevator Pos 0 Rightward setting" item, and press R or L to change the value and the Elevator mix amount when operating Rudder rightward. The mix direction will be revised by changing the sign of plus or minus before the value. The adjustable range is $\pm 125\%$.

(1.3) Elevator Pos 1 Setup: refer to "1.1 Elevator Pos 0" Setup.

(2) Aileron Setup

(2.1) Pos 0 Setup: refer to "1.1 Elevator Pos 0" Setup.

(2.2) Pos 1 Setup: refer to "1.1 Elevator Pos 0" Setup.

(3) Throttle stick setup

The switch between Pos 0 and Pos 1 can be realized by the position of Throttle Stick, then press R or L to change the value or Inhibit. Change the value to set the Throttle Stick position. The default setting is "Inhibit", the adjustable range is from 0.0 to 100.0%.

(4) Switch Setup

Switch item will display the current Switch position. Press UP or DN to make the navigation mark choose "Switch" item, and ENT to enter the selectable switch interface, press UP or DN to make the navigation mark choose the desired Switch. Press ENT to confirm and change the left sign from "0" into "1". If two or more items are selected, the item And should be selected and then the left sign "0" will be changed into "1". Press EXT to exit after finished.



3.14 Flap System

This function can modify some effects on elevator. It is possible to set 2 status of elevator through 2-way flap control switch.

Setup: press ENT to enter Main Menu in the main interface, then press UP or DN to make the navigation mark choose "Function Menu", press ENT to enter Function Menu. Press UP or DN to choose "Flap System" and then ENT to enter its setting interface.

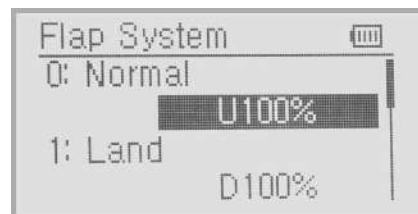

(1) Elevator Setup

There are 2 options: 0:Normal and 1:Land.

(1.1) Elevator 0:Normal position

press UP or DN to make the navigation mark choose “Elevator 0:Normal”, and press R or L to change the elevator mix amount. It is possible to change the direction by altering U or D before the amount. The default setting is 0%, and the adjustable range is U125% - D125%.

(1.2) Land position: Please refer to “1.1 Elevator 0:Normal” setting

(2) Status

Press UP or DN to make the navigation mark choose “Status”, then vibrating the flap switch(refer to 2.9 Device select) will display current position

(3) Auto land

(3.1) Throttle stick Setup

Press UP or DN to make the navigation mark choose”Throttle stick”item,and press R or L to change value or Inhibit. It is possible to set the position when changing the value.The default setting is “Inhibit”, and adjustable range is from 0.0 to 100.0%.

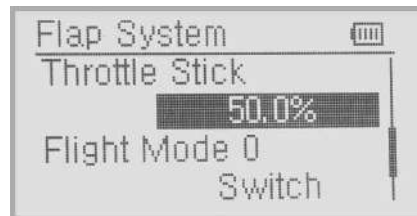
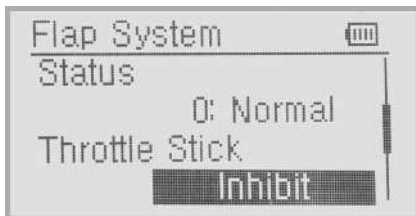

(3.2) Flight mode 0 Setup

It is possible to set a certain flight mode switch automatically after automatic land.When do this, you must come to “Wing type” setting interface under the Model Menu and make correspond Wing type Setup. Refer to 2.11 Wing type.

Press UP or DN to make the navigation mark choose “Flight mode 0” item, and press R or L to 3 options :Switch, 0:Normal and 1:Land. It is Mannul control when choose “Switch”, but Automatic control when choose Flight mode switch position.

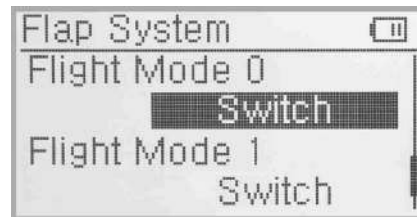

(3.3) Flight mode 1 Setup: refer to “(3.2)Flight mode 0 Setup”

Press EXT to exit after finished.

3.15 Aileron to flap mix

The function aims at mixing flap when operating aileron stick, and can set switch. The flap dual channels should also be previously activated at Wing Type in Mode Menu(refer to"2.11 Wing Type")

Setup:

Press“ENT” to enter into“main menu”; press UP or DN to make navigation mark select “function menu”, press “ENT” to enter into “function menu”; press UP or DN to select "Aileron to flap mix", press"ENT" to "Aileron to flap mix" designed interface.

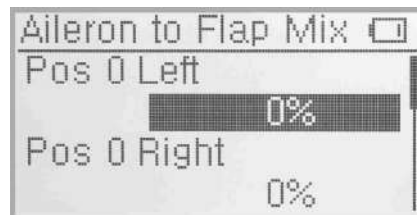

(1) Pos 0 to leftward Setup

Press UP or DN to make navigation mark select “Pos 0 to leftward setting”, press R or L to change the leftward mix value of aileron to flap, the mix direction will be revised by changing the sign of plus or minus before the value, the adjustable range is ±125%.

(2) Pos 0 to rightward Setup

press UP or DN to make navigation mark select “Pos 0 to rightward Setup”, press R or L to change the rightward mix value of ailren to flap, the mix direction will be revised by changing the sign of plus or minus before the value, the adjustable range is ±125%.

(3) Pos 0 to leftward Setup: refer above “(1) pos 0 to left Setup”

(4) Pos 0 to rightward Setup: refer above “(2) pos 0 to right Setup”

(5) Throttle stick Setup

The switch between Pos 0 and Pos 1 can be realized by setting the position of throttle stick. Press UP or DN to make navigation mark select "throttle stick setting", press R or L to change the value or inhibit. Change value can set throttle stick position. The default setting is "inhibit". The adjustable range is from 0.0% to 100.0%

(6) Switch Setup

Press UP or DN to make navigation mark select "switch" setting, press ENT to enter into usable switch interface, press UP or DN to make navigation mark select desired switch setting. Press ENT to confirm, make left sign from "0" to "1". If two or more items are selectable, the item And should be selected, to make left sign from "0" to "1", Press EXT to exit after finished.



3.16 Program mix

There are total eight sets of Program Mix, It is possible to freely set the channels and amounts which you want to select and amend, respectively.

Setting method:

press "ENT" enter to "main menu"; press UP or DN to make navigation mark select "function menu", press "ENT" to enter into "function menu"; press UP or DN to select "program mix", press "ENT" enter into "program mix", shown "program mix 1" and settable status (the factory default setting is Inhibit). Take program Mix 1 as an example.

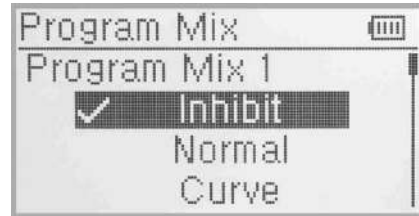

(1) Setting method for Normal in Program Mix.

Press UP or DN to make the navigation mark choose "Normal" item, and press ENT then expands up an enquiry "All Servos Hold?". Choose "OK" for all the servos will be locked at the current statuses; choose "Cancel" for unlocked. Enter the next interface after choosing.

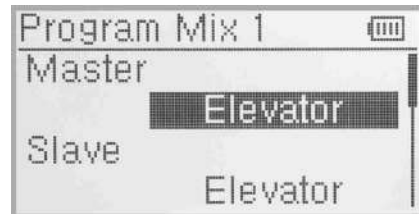
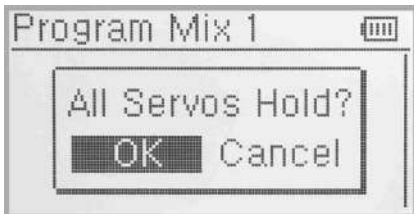

(1.1) Master Channel Setup

Press UP or DN to make the navigation mark choose "Master Channel" item, and press ENT to enter the Master Channel setting interface. Press UP or DN to choose the desired channel, then press ENT to confirm the mark "v" before chosen channel name, press ENT to return the Program Mix 1 interface.

(1.2) Slave Channel Setup

Press UP or DN to make the navigation mark choose "Slave Channel" item, and press ENT to enter the Slave Channel setting interface. Press UP or DN to choose the desired channel, and press ENT to confirm the mark "v" before the Slave Channel, and "EXT" to return Program Mix 1 interface.

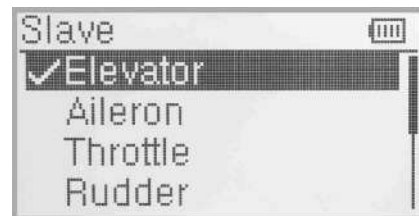

(1.1) Master Channel Setup

(1.2) Slave Channel Setup

(1.3) Gain setting:take Elevator at Master Channel as an example.

(1.3.1) Position 0 upward

Mix amount setting when elevator stick moved upward.Press UP or DN to make the navigation mark choose “position 0 upward”item,and press R or L can increase\decrease Mix amount.It is possible to reverse mix direction through changing the plus or minus sign before amount.The adjustable range is $\pm 125\%$.

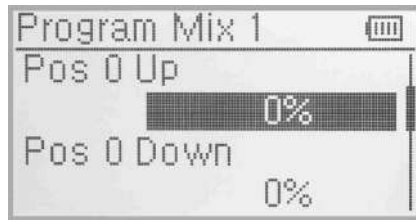

(1.3.2) Position 0 downward

Mix amount setting when elevator stick moved downward. Press UP or DN to make the navigation mark choose “position 0 downward” item, and press R or L can increase\decrease Mix amount.It is possible to reverse mix direction through changing the plus or minus sign before amount.The adjustable range is $\pm 125\%$

(1.3.3) Position one upward/downward setting method refer to (1.3.1) position zero upward setting .

(1.3.4) Offset Setup

This function can make Slave begin to mix through the corresponding Lever switch from a certain point as the starting point. Press UP or DN to make the navigation mark choose “Offset”,press R/L to increase or decrease the mix amount.It is possible to reverse the offset direction through changing the plus or minus sign before amount. The adjustable range is $\pm 100\%$.

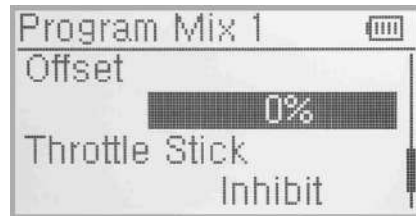

(1.4) Throtte Stick

Press “UP” or “DN” to select “throttle stick setting”.Press “R”or “L” to change the data for setting its position amunt or Inhibit. The default setting is Inhibit. The adjustable range is 0.0-100.0%.

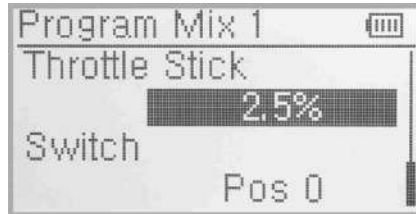
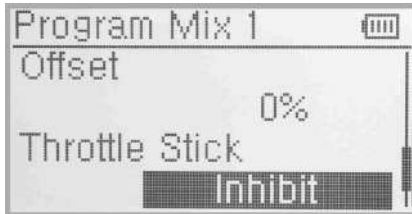

(1.5) Switch Selection

Press UP or DN to make navigation mark select “switch” setting, prss ENT enter into useable switch interface, press UP or DN to make navigation mark select desired switch setting.Press ENT to confirm,make left sign from “0” to “1”. If two or more items are selectable,the item And should be selected, to make left sign from “0” to “1”, Press EXT to exit after finished.

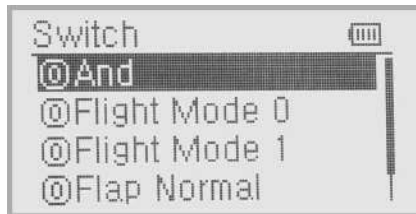

(2) Setting Method for Curve in Program Mix1

Press the item Curve in Program Mix 1 and expands an enquiry “All Servos Hold?” Click OK for all the servos will be locked at the current states; click Cancel for unlocked. Enter the next interface after clicking. Press ENT key to enter the setting interface of Program Mix1. The interface will show the setting items and curve table.

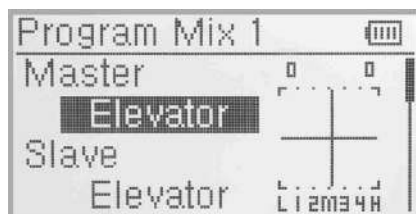
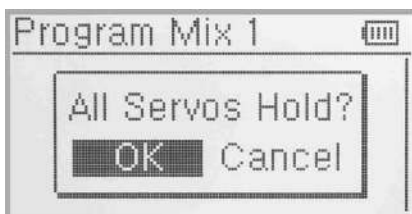

(2.1) Master Channel Setup

Press UP or DN to move the navigation mark to “Master Channel”item, and press ENT to enter the Master Channel setting interface. Press UP or DN to choose the desired channel, then press ENT to confirm the mark “√” before choosed channel name, press ENT to return the Program Mix 1 interface.

(2.2) Slave Channel Setup

Press UP or DN to move the navigation mark to “Slave Channel ”item, and press ENT to enter the Slave Channel setting interface. Press UP or DN to choose the desired channel, and press ENT to confirm the mark “√” before the Slave Channel, and “EXT” to return Program Mix 1 interface.

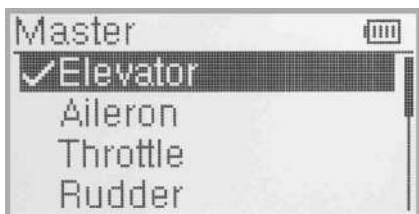

(2.1) Master Channel Setup

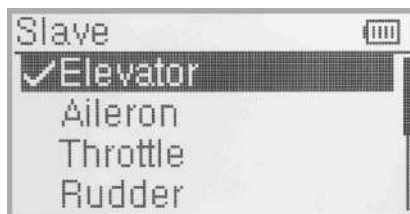

(2.2) Slave Channel Setup

(2.3) Position

There have two options:Pos 0 and Pos 1.Press “UP” or “DN”to select the desired position.

(2.4) Exponential

Press“UP”or “DN”to enter “Exponential”, and Press“R” or “L” to expand a dropdown menu with two options of Off and On. The pitch curve will be smoothly changed if choosing On. Otherwise choosing Off.



(2.3) Position

(2.5) Point Setup

Press UP or DN to move the navigation mark of Point option. Press R or L, there are 7 piont options including Point-L, Point-1, Point-2 Point-M, Point-3, Point -4 and Point-H. Select the point you want to set.

(2.6) Status Setup

(There is no Status options when the piont is Point-L or Point-H). After selecting the point that you want to set, press UP or DN to move the navigational mark to Status item. Press R or L, there are two options of Inhibit and Active. Select Inhibit for unchanging the current amount (the default setting is Inhibit).

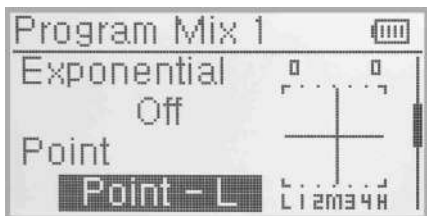

(2.5) Point Setup

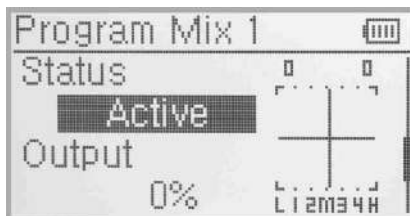

(2.6) Status Setup

(2.7) Output

When the Status option is Active, the Output option will be listed.Press UP or DN to move the navigational mark to Output. Press R or L to increase or decrease, respectively, the output amount. It is possible to reverse the mix direction by changing the plus or minus sign before the amount. The adjustable range is ±100%.

(2.8) Throttle Stick Setup

Press “UP” or “DN” to select “throttle stick setting”. Press “R”or “L” to change the data for setting its position amunt or Inhibit. The default setting is Inhibit. The adjustable range is 0.0-100.0%.

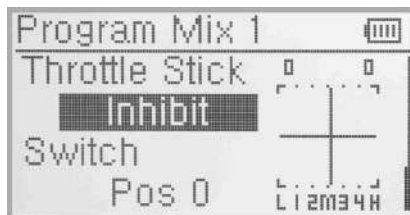

(2.9) Switch Selection

Press UP or DN to make navigation mark select “switch” setting, prss ENT enter into useable switch interface, press UP or DN to make navigation mark select desired switch setting.Press ENT to confirm,make left sign from “0” to “1”. If two or more items are selectable,the item And should be selected,to make left sign from “0” to “1”, Press EXT to exit after finished.



Press “EXT” to return to the interface of Program Mix for other setting. Or Press “EXT” once again to exit.

3.17 Monitor

The monitor function allows the pilot to monitor the outputs of each transmitter channel.

Press ENT to Main Menu, and use UP or DN to select Function Menu.Press ENT to enter the Function Menu and then use UP or DN to select Monitor and press ENT to enter the monitor interface for checking the current working status of each channel(See rightside View). Press EXT to exit .

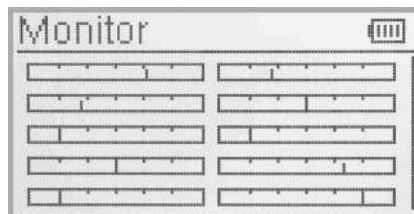

3.18 Fail safe

Two options exist if the receiver loses the connection with the transmitter; the first is HOLD - keep the last action data received, the second is to use a pre-set failsafe value. The default setting is Servo Hold.

Setup:

Press ENT to Main Menu, use UP or DN to select Function Menu. Press ENT to Function Menu then use UP or DN to select Fail Safe and press ENT to enter the Fail Safe interface.Take the item Elevator as an example to explain.



Use UP or DN to select Elevator on the Fail Safe interface, then press R or L to change the status of Servo Hold into Fail Safe(If you want to keep Servo hold status, there is no need to re-set). There is a expanded sub-item below. Press UP or DN to select 0%, then press R or L to increase or decrease the value, respectively, the position amount which centers on the neutral point of servo. The available value is 125%,respectively. 0% is the neutral point of servo.



The setting methods for other channels are same as above. Press EXT to exit after finished.

NOTE: If the helicopter enters a failsafe mode for any reason power should be disconnected from the Heli and it must be thoroughly checked over before flying again. Using 100% throttle after a failsafe event may be dangerous and cause injury or damage.

3.19 Sensor View

The function can be performed by Activate the Sensor Status in the Model Menu, and it is a must that the receiver also has telemetry function.

Sensor View Setup: Press ENT to enter the Main Menu and use UP or DN to select the Function Menu. Press ENT to Function Menu. Use UP or DN to select Sensor View, then press ENT to enter the Sensor View interface. See below views. If all the sensors disconnect, there will be inhibits shown on the view, means the telemetry signal lost. If all work normal, all the measured data will be shown.

(1) Voltage: Provide 3 different measured voltage values;

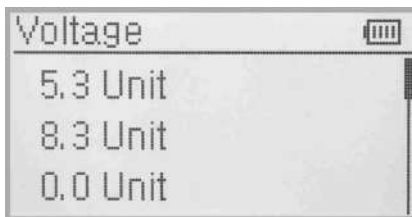

(2) Temperature: Press UP or DN to Temperature, which provides 4 different measured temperature values;

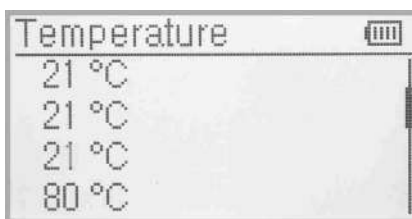
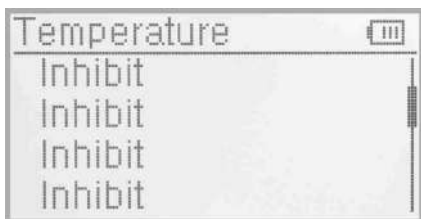

(3) Rate Sensor: Press UP or DN to Rate Sensor, which provide 2 different measured RPM values;

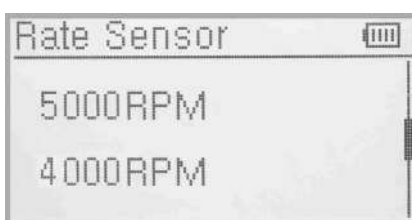

(4) GPS Sensor: Press UP or DN to turn to GPS Sensor, show located date, time, longitude, latitude, altitude and speed;

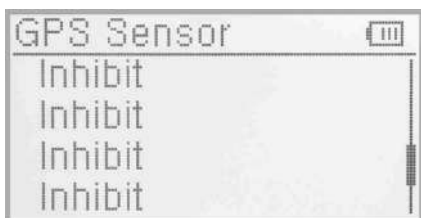

3.20 Trainer

To help the beginner pilot it is possible to make two DEVO 7E transmitters operate together using a training function. The training function permits the teacher to limit or override the controls of the trainee. The instructions for using the training function are below:

(1) Data copy

The first step is to copy the model settings from the teacher's DEVO 7E to the trainee's DEVO 7E, this guarantees that the model data in both transmitters is identical. To do this refer to the copy method as described in Helicopter setup section "2.4 model wireless copy". Once completed, follow the steps below:

(2) Connection

Insert the signal wire (supplied) into the DSC socket of the trainee's transmitter. Turn on the trainee's transmitter and the display will alternate between showing PC (data connection mode) and the model name (MOD), see image (right) from the trainer's transmitter into the DSC socket of the trainee's transmitter. Turn on the transmitter and a linkage icon will be shown on the boot screen.

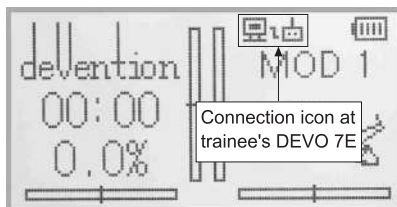

Linkage Display

Next, turn on the Trainer's DEVO 7E. Select the newly copied model data using the MODEL Menu. Bind to the aircraft and make a small test flight to confirm the aircraft is operating normally. Turn off the power and insert the digital signal wire into the trainer's DEVO 7E DSC port. Turning back on the power will automatically put the DEVO 7E into training mode.



Trainer icon

Training Status Display: when the trainer's icon turns to "X", the trainee stops flying and the trainer is working; when the trainer's icon turns to "✓", the trainee is flying and the trainer is in leisure.

(3) Usage

The default setting of the training switch is "R+" key. During flight, if the trainer press "R+" key, the linkage icon will be shown as "✓" that means the control right is moved to the trainee from trainer. If trainer pushes "R+" key once again, the linkage icon will be show as "X" that means the trainer takes back the control right from the trainee.



(4) Setting for training function channels

Trainee is available to get full or part of flight control power to the aircraft model via setting the training function channel in the trainer's radio. Below is the Setup:

Press the ENT to Main Menu, use UP or DN to Function Menu. Use UP or DN to select Trainer and press ENT to enter Trainer interface. The available channels are shown between Elevator, Aileron, Throttle, Rudder, Gear, Pitch and Gyro, and the current status of trainer switch is also shown there.

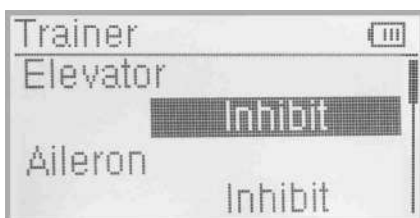

Channel selection:

Press UP or DN to select the channel option; press R or L to select the channel(s) which you want to grant to trainee. The channel(s) you have selected will be activated as "Active". The channel(s) which are not granted to trainee will be kept inhibited. The default setting is "Inhibit".

Press EXT to exit.

3.17 Timer

There are two timers on the DEVO 7E, stopwatch and countdown timer. These timers are activated by switch or by shortcut.

Setup:

Press ENT to Main Menu, use UP or DN to Function Menu. Press ENT to enter Function Menu. Use UP or DN to choose Timer, and press ENT to enter Timer setting interface. The factory default is Stopwatch, and the timing range of stopwatch is from 0 to 60.

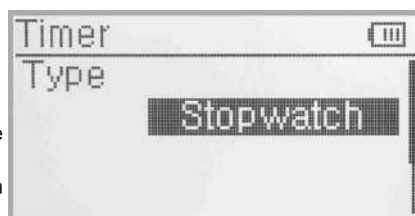

(1) Countdown setting

Press R or L to select Countdown. There is an expand sub-menu Set Time. Press UP or DN to Set Time interface, use R or L to set up countdown time. The timing rang is from 00:10-to 60.

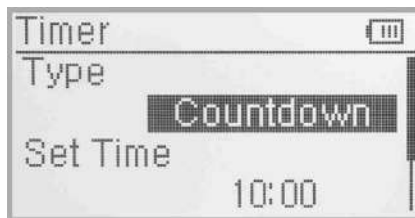

(2) Switch selection

Press UP or DN to move the navigational mark to Switch. There are Inhibit and available switch options, use L or R to choose switches between FMOD SW, HOLD SW, SPS0 SW, SPS1 SW, SPS2 SW and SPS3 SW. Select the desired item except these items of SPS0 SW, SPS1 SW, SPS2, and SPS3 which should be previously set at Stick Position Switch at Model Menu (refer to “2.8 Stick Position Switch”). Press EXT after finished.

(3) Usage of timer

Use the UP key to start and stop the timer. Use DN to reset the timer. You can also set switches to control the timer. Below is the picture of timer display on the boot screen .

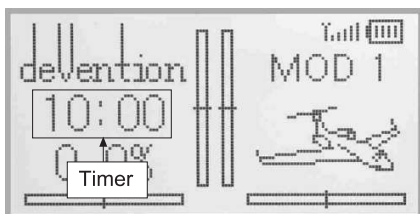

4.0 Upgrading

Software can be upgraded in PC via downloading or uploading the configuration files.

Enter upgrading interface: Press EXT and power on the radio when the radio is in powered off status, below illustration will show as below.



The operation guide for connecting to PC upgrading should be mentioned with upgrading software.

5.0 Hot keys usage

We offer two hot keys R+, L- for this Radio. With them, you can enter into the gyro sensor and throttle curve setting interface quickly.

Method: Press R+ once on the main interface to enter into the gyro sensor setting interface. Press L- once, you can enter into the throttle curve setting interface.



This symbol indicating separate collection for electrical and electronic equipment.



Add.: Taishi Industrial Park, Dongchong Town
Panyu District, 511475 Guangzhou

Tel.: (8620) 8491 5115 8491 5116

Fax.: (8620) 8491 5117

Web: www.walkera.com

Email: heli@walkera.com
info@walkera.com

The specifications of the R/C Product
may be altered without notice.

