

DJI DIGITAL FPV SYSTEM

User Manual

v1.0 2019.07

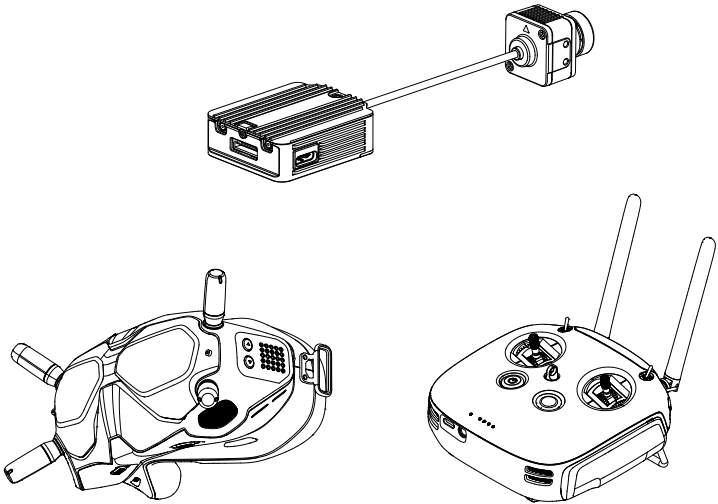

Searching for Keywords

Search for keywords such as “battery” and “install” to find a topic. If you are using Adobe Acrobat Reader to read this document, press Ctrl+F on Windows or Command+F on Mac to begin a search.

Navigating to a Topic

View a complete list of topics in the table of contents. Click on a topic to navigate to that section.

Printing this Document

This document supports high resolution printing.

Using This Manual

Legends

 Warning

 Important

 Hints and Tips

 Reference

Read Before First Usage

Read the following documents before using the DJI™ Digital FPV System:

1. DJI FPV Air Unit Quick Start Guide
2. DJI FPV Remote Controller Quick Start Guide
3. DJI FPV Goggles Quick Start Guide
4. DJI FPV Goggles Disclaimer and Safety Guidelines
5. DJI Digital FPV System User Manual

Watch all the tutorial videos on the official DJI website and read the disclaimer to understand your legal rights and responsibilities. Prepare to use for the first time by reviewing the quick start guides and refer to the user manual for more information. If you have any questions or problems during the installation, maintenance, or use of this product, contact DJI or a DJI authorized dealer.

Video Tutorials

Watch the tutorial videos in the link below, which demonstrate how to use the DJI Digital FPV System safely: <http://www.dji.com/fpv/video>

Download DJI Assistant 2 (DJI FPV Series)

Download DJI ASSISTANT™ 2 at <http://www.dji.com/fpv/downloads>

DJI Assistant 2 supports Windows 7 (or later) or Mac OS X 10.11 (or later).

Warning

Always stay alert when using the DJI Digital FPV System to control an unmanned aerial vehicle (UAV). Carelessness may result in serious harm to yourself and others.

DJI FPV Air Unit

1. The DJI FPV Air Unit may become hot during or after operation. DO NOT touch the air unit before it cools down.
2. DO NOT use the air unit for an extended period when the temperature is high or there is poor ventilation. Otherwise, the air unit may overheat and enter low-power mode, which will affect its performance. Restart the air unit or wait for it to cool down and exit low-power mode.
3. Make sure that the external power source for the air unit is a lithium battery and within 7.4 - 17.6 V. Otherwise, the air unit may be damaged and may not work properly.
4. DO NOT connect the power cable with the power GND cable directly or plug or unplug the cables when the air unit is powered on. Otherwise, the equipment may be damaged and may not work properly.
5. DO NOT obstruct or twist the antennas of the air unit. Otherwise, the transmission may be affected or blocked.
6. Follow the instructions in the quick start guide or user manual when installing the air unit. Incorrect installation may cause the air unit to not work properly.
7. Keep all the electronic devices as far away from each other as possible during installation to minimize electromagnetic interference.
8. Make sure that all connections are secure and all parts are working properly.
9. Make sure that there are no other transmitting devices in the surrounding area that may cause interference. DO NOT use the same frequency band as other devices. Otherwise, the transmission of the DJI Digital FPV System will be affected.

DJI FPV Goggles

1. DO NOT throw or drop the product. Otherwise, it may be damaged. If the product is damaged, take it to a DJI Service Center for inspection and repair.
2. Keep the lenses away from direct sunlight to avoid screen burns.
3. Only use official DJI power cables and an external power supply that meet the specification requirements (7.4-17.6 V). Use of improper accessories may lead to product damage, void the warranty, and even property damage and personal injury.
4. The DJI FPV Goggles may become hotter than normal if used for an extended period. If the product overheats, turn off the device as instructed to avoid injury or product damage.
5. DO NOT use or store the DJI FPV Goggles in adverse weather conditions or environments with high levels of humidity or dust.
6. DO NOT attempt to disassemble or modify this product. Unauthorized disassembling or modification will void the product warranty.
7. To avoid damaging the power cable, do not jerk, knot, sharply bend, or abuse the cable in any way. DO NOT expose the cable to sources of heat or liquid. Keep children and animals away from the cable.

8. When not using the DJI FPV Goggles, keep the product away from heat, liquid, fire, and direct sunlight.
9. DO NOT use the DJI FPV Goggles if any part or component is broken or damaged. DO NOT attempt to repair any part of the device yourself. If the product is damaged, take it to a DJI Service Center for inspection and repair.
10. Detach and store the antennas from the DJI FPV Goggles when the goggles are not in use. Make sure to store the antennas carefully to avoid damage.

DJI FPV Remote Controller

1. Fully charge the remote controller before each flight.
2. If the remote controller is powered on and has not been used for five minutes, it will vibrate. Move the control sticks or perform an action to cancel the alert.
3. Make sure the antennas are unfolded and adjusted to the proper position for optimal transmission.
4. Contact DJI Support to repair or replace the antennas if they are damaged. Damaged antennas will greatly decrease performance.
5. If you change the connected device, link the remote controller and the device again.
6. Make sure to power off the aircraft before the remote controller.
7. Fully charge the remote controller every three months.
8. The remote controller will beep and vibrate when the battery level decreases to 10%. Immediately charge the remote controller to prevent it from being damaged due to over discharge for an extended period. Discharge the remote controller to a battery level between 40% and 60% if storing for an extended period.
9. DO NOT cover the air vent or the air intake on the remote controller. Otherwise, the remote controller may overheat, which could affect its performance.
10. DO NOT disassemble the remote controller without the assistance of an authorized DJI dealer. Contact DJI or an authorized DJI dealer to replace components of the remote controller.

Contents

Using This Manual	2
Legends	2
Read Before First Usage	2
Video Tutorials	2
Download DJI Assistant 2 (DJI FPV Series)	2
Warning	3
DJI FPV Air Unit	3
DJI FPV Goggles	3
DJI FPV Remote Controller	4
Product Profile	7
Introduction	7
At a Glance	8
Activation	10
DJI FPV Air Unit	11
Introduction	11
Installation and Connection	11
Operating Channel	12
DJI FPV Goggles	14
Introduction	14
Installation and Wearing	14
Power Supply	15
Operation	16
Video Play	16
DJI FPV Remote Controller	17
Introduction	17
Operation	17
Status Indicators and Alarms	18
Stick Adjustment	19

Using the DJI Digital FPV System	21
Linking	21
Goggles Main Screen	25
Goggles Settings	27
Flight Controller and Remote Controller Settings	29
Video Recording	31
Updating Firmware	32
Maintenance	32
DJI FPV Goggles	32
DJI FPV Air Unit	33
Specifications	35

Product Profile

Introduction

DJI Digital FPV System

The DJI Digital FPV System consists of the DJI FPV Air Unit, DJI FPV Goggles, and DJI FPV Remote Controller, featuring the DJI HD Low Latency FPV Transmission, to provide an integrated video transmission with high definition and low latency for racing flight. The DJI Digital FPV System supports a 5.8 GHz digital video signal and 720p 120fps image transmission, with a transmission range of up to 4 km and a minimum end-to-end latency within 28 ms*. Up to eight fixed channels are supported**, and the enhanced anti-interference ability greatly improves the smoothness and stability of the video transmission. The DJI Digital FPV System integrates a camera, video transmission, display view, and remote control to provide a high-quality racing experience.

Typical Application Scenario

The DJI FPV Air Unit includes the air unit module and camera, which can be mounted on a racing drone and used with the goggles or a remote controller to transmit video, control signals, and flight controller information wirelessly.

The DJI FPV Goggles are equipped with a high-performance display and support 810p 120fps HD display. When used with a racing drone equipped with the air unit, users can enjoy a first-person view of their aerial experience in real time.

The DJI FPV Remote Controller works with the air unit and goggles, and can be used to control the aircraft and operate the menu screen of the goggles to set parameters.

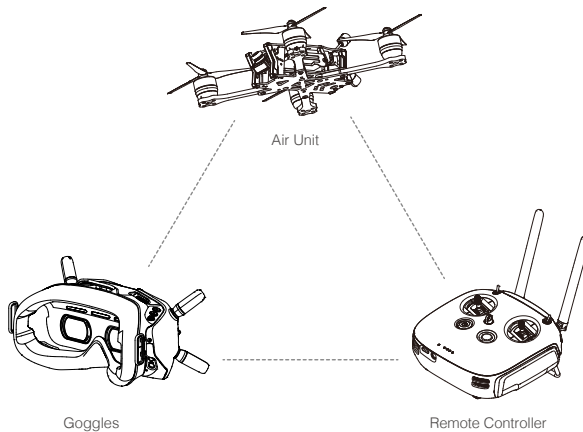

* The end-to-end latency is the total time from camera input to screen display. The DJI Digital FPV System can reach its minimum latency in Low Latency mode (720p 120fps), and achieving maximum transmission distance (FCC) in a wide open area with no electromagnetic interference. The aircraft will fall if the video or control signal is disconnected. Be careful when flying at low altitudes and long distances.

** There are up to eight channels for the DJI Digital FPV System depending on the region (FCC: eight, CE/SRRC: four, MIC: three). Each channel has a bandwidth of 20 MHz. The public channel is 8, which is the default channel when the equipment is powered on. The channel can be changed manually to avoid interference from other devices.

At a Glance

DJI FPV Air Unit

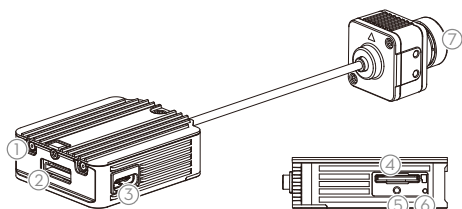

1. MMCX Antenna Ports
2. 3-in-1 Port
3. USB-C Port
4. microSD Card Slot
5. Link Button
6. Linking Status Indicator
7. Camera

DJI FPV Goggles

1. Antennas
2. Front Cover
3. Channel Adjustment Buttons
4. Channel Display
5. USB-C Port
6. microSD Card Slot
7. Air Intake
8. Interpupillary Distance (IPD) Slider

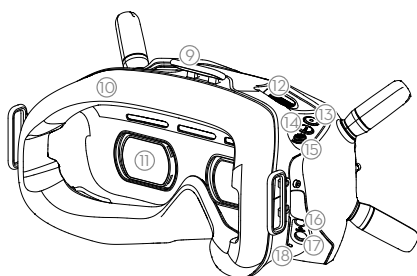
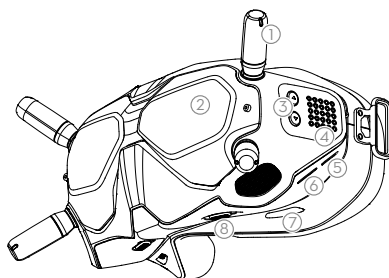

9. Headband Attachment
10. Foam Padding
11. Lens
12. Air Vent
13. Record Button
14. Back Button
15. 5D Button
16. Audio/AV-IN Port
17. Power Port (DC5.5x2.1)
18. Link Button

DJI FPV Remote Controller

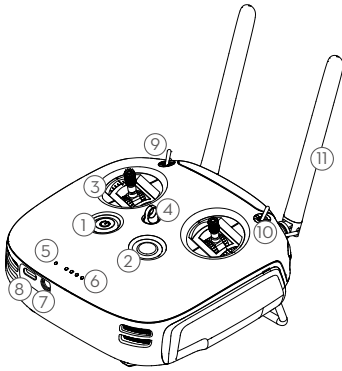

1. Power Button
2. C Button (customizable)
3. Control Sticks
4. Lanyard Attachment
5. Status LED
6. Battery Level LEDs
7. Simulator PPM Port
8. USB-C Port
9. SB Switch
10. SC Switch
11. Antennas

12. Left Dial
13. Record Button
14. SA Switch
15. Right Dial
16. SD Switch
17. Back Button
18. Right Stick Adjustment Screw (Horizontal)
19. Right Stick Adjustment Screw (Vertical)
20. Throttle Stick Adjustment Screws* (Mode 1)
 - a. Ratchet Throttle Adjustment Screw
 - b. Smooth Throttle Adjustment Screw
21. Throttle Stick Adjustment Screws* (Mode 2)
 - a. Smooth Throttle Adjustment Screw
 - b. Ratchet Throttle Adjustment Screw
22. Left Stick Adjustment Screw (Vertical)
23. Left Stick Adjustment Screw (Horizontal)
24. Battery Cover
25. Battery Cover Lock

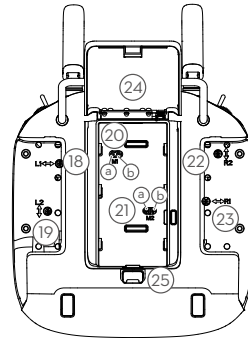
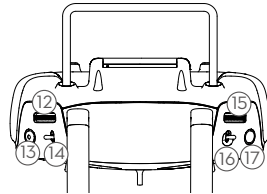

* To choose between a ratchet throttle and a smooth throttle, users must adjust the throttle stick adjustment screw that corresponds to the current control mode. Depending on the control mode, the corresponding vertical stick adjustment screw is unavailable.

Activation

When powered on, connect the device to your computer by the USB-C port and run DJI Assistant 2 for activation.

 Make sure to activate the device before using for the first time. Otherwise, some functions will be unavailable:

- If the air unit is not activated, its transmission power will be limited (≤ 25 mW), and the menu screen of the connected goggles cannot be operated.
 - If the goggles are not activated, only linking is available and the menu screen cannot be operated. Additionally, the device will also be set in the public channel and cannot be set to other channels after linking. Note that the public channel is easily prone to interference from other transmission devices.
 - If the remote controller is not activated, it cannot be used to operate the menu screen of the connected goggles.
-

DJI FPV Air Unit

Introduction

The DJI FPV Air Unit is an advanced video transmission module that supports a 5.8 GHz digital video signal and 720p 120fps image transmission, with a transmission range of up to 4 km and a minimum end-to-end latency within 28 ms. The air unit can be mounted on a racing drone and used with the goggles or remote controller to transmit video, control signals, and flight controller information wirelessly.

Installation and Connection

Air Unit Module

Refer to the illustration below to mount and connect the air unit to a racing drone.

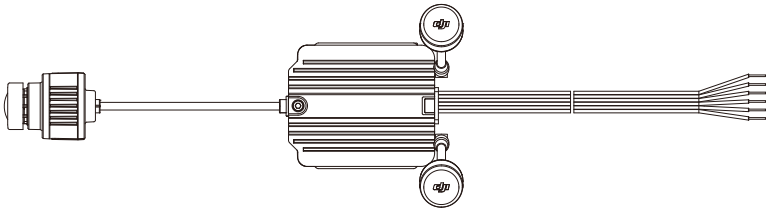

3-in-1 Cable (Power, DJI HDL, UART)

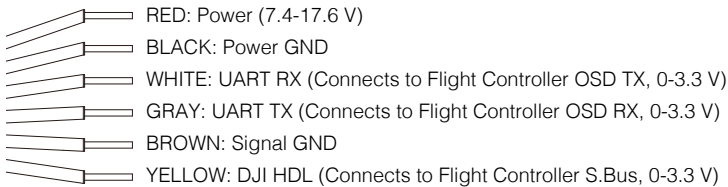

An electric soldering iron and soldering tin are required for connection. Make sure that there are no short circuits or open circuits when soldering the cables.



- The air unit may become hot during or after operation. DO NOT touch the air unit before it cools down.
- DO NOT use the air unit for an extended period when the temperature is high or there is poor ventilation. Otherwise, the air unit may overheat and enter low-power mode which will affect the performance.
- Keep the antennas of the air unit at least 40 mm apart. Keep the air unit away from metal objects or carbon fiber frames. Make sure to choose a position where the transmission will not be blocked during flight.

Camera Module

Four M2 screws are attached to both sides of the camera, which can be removed and used to mount the camera to the aircraft frame, and adjust to an appropriate angle based on your requirements.

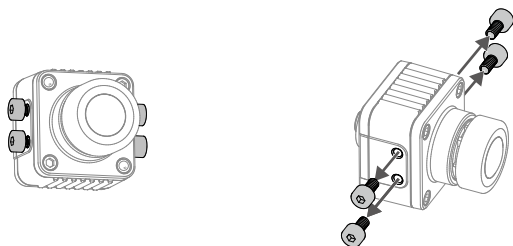

If you need to mount the lens protector for the camera, follow the steps below.

1. Remove the two screws without glue, mount the lens protector onto the camera, and tighten the two screws.
2. Peel off the adhesive on the protective lens and attach it to the lens protector.

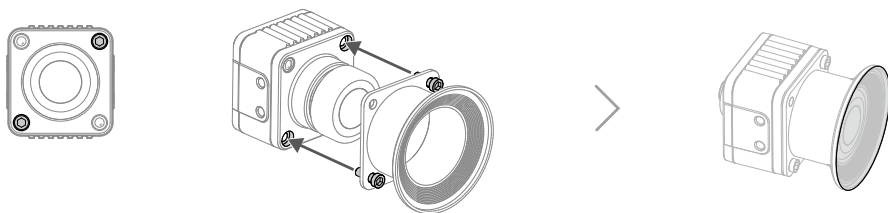

 The DJI FPV Lens Protector is sold separately.

 Only the two screws without glue can be removed. If you remove the two screws that are glued, the warranty will be voided.

Operating Channel

There are up to eight channels for the air unit depending on the region (FCC: eight, CE/SRRC: four, MIC: three). Each channel has a bandwidth of 20 MHz. The public channel is 8, which is the default channel when the equipment is powered on. The channel can be changed manually to avoid interference from other devices.

Central frequency (MHz)	Channel 1	Channel 2	Channel 3	Channel 4	Channel 5	Channel 6	Channel 7	Channel 8
FCC	5660	5695	5735	5770	5805	5878	5914	5839
CE/SRRC	5735	5770	5805	-	-	-	-	5839
MIC	5660	5700	-	-	-	-	-	5745

 The control signal that the goggles or the remote controller transmit to the air unit is a frequency-hopping signal within the bandwidth.

-  • Make sure you fully understand and abide by local laws and regulations before using this product.
- An amateur radio license may be needed in FCC regions when using channels 1, 2, 6, or 7, as they are amateur frequency bands. Users who use the amateur frequency bands with a modified or cracked version or without a license may be punished for breaking local laws or regulations.
-

Power on and connect the air unit to DJI Assistant 2. The air unit will update to the radio mode of the current region automatically. When the goggles or remote controller are connected to the air unit, the region of their radio modes will also update automatically.

DJI FPV Goggles

Introduction

The DJI FPV Goggles are equipped with a high-performance display and DJI HDL FPV transmission technology, with a transmission range of up to 4 km and a minimum end-to-end latency within 28 ms. When used with a racing drone equipped with the DJI FPV Air Unit, users can enjoy a first-person view of their aerial experience in real time. The goggles support 810p 120fps HD display and up to eight selectable transmission channels, providing users with a smooth and stable high-definition racing experience.

The DJI FPV Goggles can also be used to play video to bring you an immersive high-definition viewing experience.

Installation and Wearing

1. Install the four antennas to the mounting holes on the front of the goggles. Make sure that the antennas are installed securely.

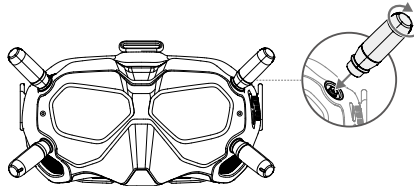

2. Attach the strap to the headband attachment on the top and sides of the goggles.

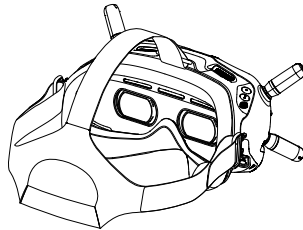

3. Align the lenses over your eyes and pull the headband down. Adjust the headband size until the goggles fit securely and comfortably on your face and head.

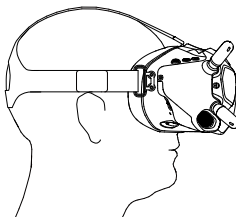

4. Turn the IPD knob to adjust the distance between the lenses until the images are properly aligned.

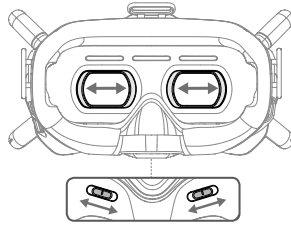



Adjusting the Interpupillary Distance
(58-70 mm)

 The goggles can be worn over glasses.

Power Supply

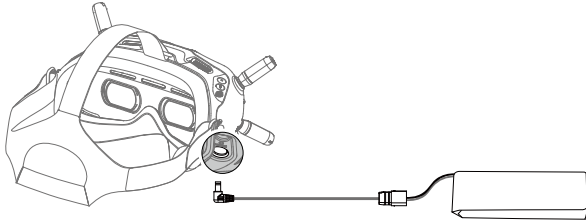
Use the included power cable to connect the power port of the goggles to an external power supply.



 The external power supply is not included in the package. Prepare an external power supply with an input voltage of 7.4-17.6 V.

Operation



5D Button

Toggle the button to scroll through the menu. Press the button to confirm.

In the main screen, press the button to enter the menu bar. Toggle left or right to quickly adjust the screen brightness. Toggle up or down to quickly adjust camera settings. The default adjustable setting is scene, which can be changed to FOV, exposure, or other settings.



Record Button

Press to start or stop video recording.



Back Button

Press to return to the previous menu or exit the current mode.



Channel Adjustment Buttons

Press the up or down button to switch channels 1 to 7.

Channel Display

Displays the current channel of the goggles.

Video Play

Review your flight videos or other HD videos through the goggles for an immersive viewing experience.

Insert the microSD card on the air unit or another microSD card containing video into the microSD card slot, select playback, and choose a video in the menu bar to play the video.



- During video playback, toggle the 5D button up or down to adjust the volume. Toggle the 5D button left or right to adjust the progress bar.
- Make sure the video files are stored in the DCIM\100MEDIA in the root or the root directory of the microSD card. Only MP4, MOV, and MKV formats are supported. Refer to Specifications for more information. The video supports up to 4K 30fps.

DJI FPV Remote Controller

Introduction

The DJI FPV Remote Controller features advanced DJI HDL FPV Transmission technology with a transmission range of up to 4 km and latency as low as 7 ms, enhancing the anti-interference ability and improving the stability of the video transmission. With replaceable batteries that can be quickly hot-swapped, the remote controller also features customizable buttons. Equipped with stick adjustment screws, users can easily adjust the smoothness of the control sticks to suit their preferences.

Operation

Charging the Battery

To activate the battery, fully charge it before using for the first time.

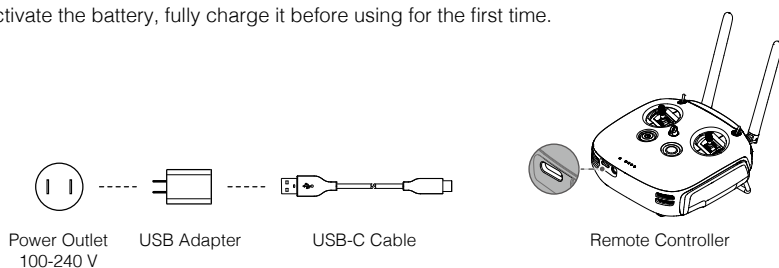

⚠ It is recommended to use the USB adapter of DJI Goggles RE, RONIN™-S, SPARK™, or an FCC/CE certified USB adapter that supports Quick Charge 2.0.

Mounting the Battery

1. Slide the battery cover lock on the back of the remote controller down to open the cover.
2. Insert the Intelligent Battery into the compartment. Press the battery into place, and push upward until there is a click.
3. Close the cover.

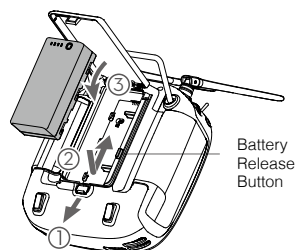

⚠ To remove the Intelligent Battery, open the cover, press and hold the battery release button, and push the battery downward.

Checking the Battery Level and Powering On/Off

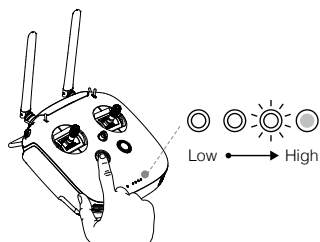

Press once to check the battery level.

Press once, and press again and hold for two seconds to turn on or off.

Preparing the Antennas

Unfold and adjust the antennas of the remote controller. The signal strength varies depending on the position of the antennas.

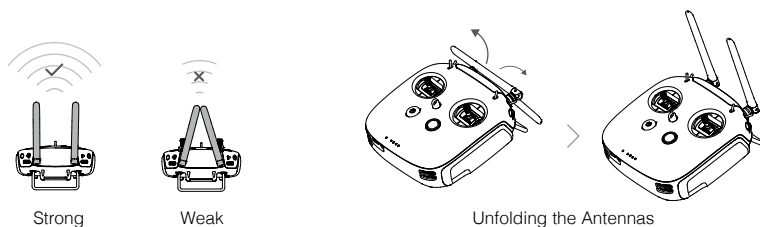

Try to keep the aircraft inside the optimal transmission range. If the signal is weak, adjust the antennas or fly the aircraft closer.

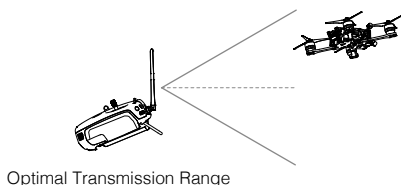

Status Indicators and Alarms

Status Indicator	Alarm	Description
Solid Green	/	Linked
Blinks Blue	Beeps at medium speed	Linking
Blinks Purple	/	The remote controller is in lock mode
/	Beeps alternate sounds and vibrates to alert	The remote controller need to be calibrated
/	Beeps and vibrates to alert	Low battery (battery level <10%)
/	Beeps at slow speed	The throttle stick is not in the lowest position

- ☀️ Press and hold the C button to make the remote controller enter lock mode to avoid misuse. The remote controller will be locked and will not send any signal to the connected device. Press and hold the C button again to unlock.

Stick Adjustment

For better user experience, adjust the stick length and tension. The tension controls how quickly the stick returns to the neutral position.

Adjusting Stick Length

1. Hold Stick Head B, and rotate Stick Head A counterclockwise to unlock.
2. Rotate Stick Head B to increase or decrease the stick length.
3. Hold Stick Head B, and rotate Stick Head A clockwise until it is locked.

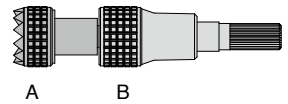

Adjusting Stick Tension

1. Turn the remote controller over and lift the rear rubber grips, beginning from the groove on the top.

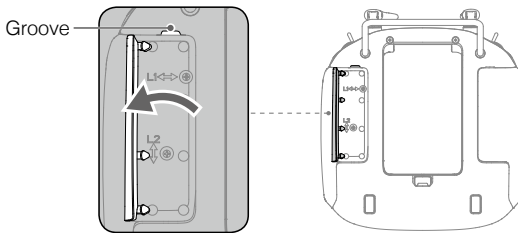

2. The screws under the grip on both sides can adjust the tension of the corresponding stick on the front of the remote controller. Use a Philips screwdriver to adjust the stick tension for horizontal or vertical direction. The tension increases when tightening the screws, and the tension decreases when loosening the screws.

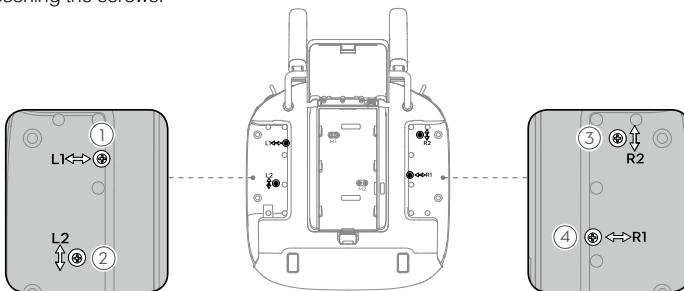

- ① Right Stick Adjustment Screw (Horizontal)
- ② Right Stick Adjustment Screw (Vertical)

- ③ Left Stick Adjustment Screw (Vertical)
- ④ Left Stick Adjustment Screw (Horizontal)

3. Open the battery cover and remove the Intelligent Battery.
4. Check the current control mode, and then tighten or loosen the screws to adjust the throttle stick to your preference.

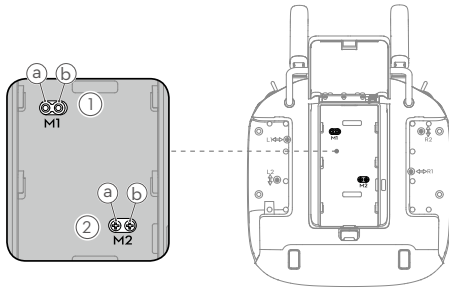

- ① Throttle Stick Adjustment Screws* (Mode 1)
 - a. Ratchet Throttle Adjustment Screw
 - b. Smooth Throttle Adjustment Screw
- ② Throttle Stick Adjustment Screws* (Mode 2)
 - a. Smooth Throttle Adjustment Screw
 - b. Ratchet Throttle Adjustment Screw

Smooth	Ratchet
Tighten the Smooth Throttle Adjustment Screw	Tighten the Ratchet Throttle Adjustment Screw
Loosen the Ratchet Throttle Adjustment Screw	Loosen the Smooth Throttle Adjustment Screw

5. After adjustment, install the rubber grips, insert the Intelligent Battery, and close the cover.

-
- ⚠** • Make sure that both throttle adjustment screws are not tightened or loose. Otherwise, the desired effect cannot be achieved.
- To choose between a ratchet throttle and a smooth throttle, users must adjust the throttle stick adjustment screw that corresponds to the current control mode. Depending on the control mode, the corresponding vertical stick adjustment screw is unavailable.
-

Using the DJI Digital FPV System

Linking

The DJI Digital FPV System supports three linking methods.

Air Unit + Goggles



1. Power on the air unit and goggles.
2. Press the link button on the air unit when the linking status indicator is solid green. The indicator is solid red when the air unit is ready to link.
3. Press the link button on the goggles. They will start to beep continually.

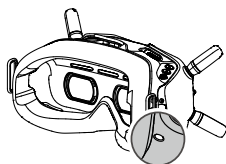

4. Make sure the distance between the air unit and the goggles is within 2 m. When linking is successful, the linking status indicator of the air unit turns solid green, the goggles stop beeping, and the live view will be displayed.

Air Unit + Remote Controller

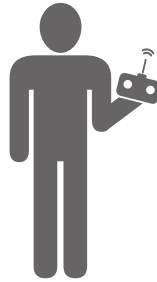

1. Power on the air unit and remote controller.
2. Press the link button on the air unit when the linking status indicator is solid green. The indicator turns solid red when the air unit is ready to link.
3. Press the record button, C button, and the right dial on the remote controller simultaneously. The remote controller beeps continually and the status indicator blinks blue.



4. Make sure the distance between the air unit and the remote controller is within 2 m. When linking is successful, both the linking status indicators turn solid green and the remote controller stops beeping.

Air Unit + Goggles + Remote Controller

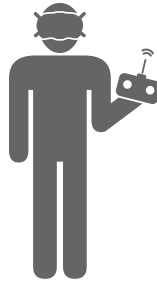

1. Power on the air unit, goggles, and remote controller.
2. Press the link button on the air unit when the linking status indicator is solid green. The indicator will turn solid red when the air unit is ready to link.
3. Press the link button on the goggles. They will start to beep continually.

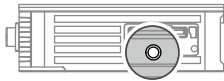

4. Make sure the distance between the air unit and the goggles is within 2 m. When linking is successful, the linking status indicator of the air unit turns solid green, the goggles stop beeping, and the live view will be displayed.
5. Press the link button on the air unit when the linking status indicator is solid green. The indicator turns solid red when the air unit is ready to link.
6. Press the record button, C button, and right dial on the remote controller simultaneously. The remote controller beeps continually and the status indicator blinks blue.

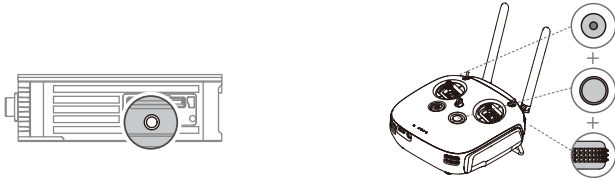

7. Make sure the distance between the air unit and the remote controller is within 2 m. When linking is successful, both the linking status indicators turn solid green and the remote controller stops beeping.

 The goggles and remote controller can save all the air units which have been linked to them. There is no limit to the number of air units that can be saved. Once an air unit has been linked with goggles or remote controller, it is not required to link again. Just power on the air unit and start to use.

-
-  • To use the goggles and remote controller together, the air unit must be linked to the goggles before the remote controller. Otherwise, the connection between the three devices cannot be established and will not be saved.
- The air unit can only save one set of connected devices. If the air unit is linked with another set of devices, the original devices will be replaced.
-

Goggles Main Screen

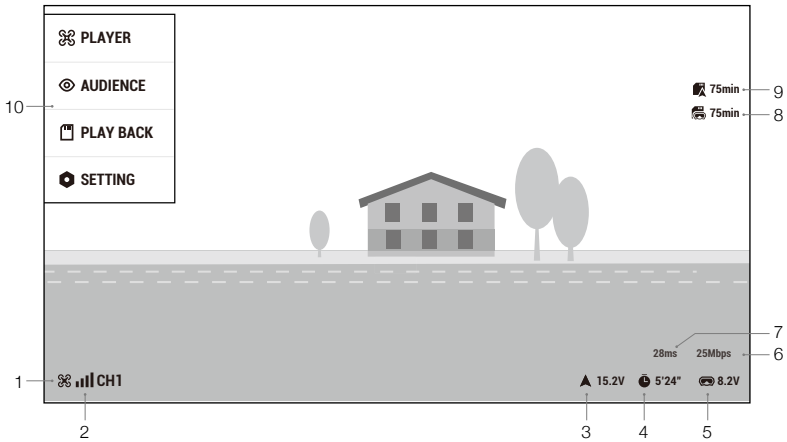

1. Linking Status

Shows whether or not the goggles are linked to the air unit.

2. Transmission Channel and Signal Strength

Shows the current channel and the signal strength of the goggles and the air unit.

3. Aircraft Voltage

Shows the battery voltage of the aircraft battery as read by the flight controller.

4. Flight Time

Shows the flight time of the aircraft after starting motors. The record will be cleared when the motors stop.

5. Goggles Voltage

Shows the battery voltage of the goggles. The goggles will beep when the voltage is too low.

6. Transmission Bandwidth

Shows the bandwidth of the operating channel between the air unit and the goggles.

7. Transmission Latency

Shows the total time from camera input to screen display.

8. Goggles microSD Card Status

Shows whether or not a microSD card is inserted in the goggles and the remaining capacity. A flashing icon will appear when recording.

9. Air Unit microSD Card Status

Shows whether or not a microSD card is inserted in the air unit and the remaining capacity. A flashing icon will appear when recording.

10. Menu Bar

Press the 5D button on the goggles, or press the right dial of the remote controller to enter the menu bar.

a) Player

Shows the occupancy of each channel. The red **RACING** means occupied. You can select a vacant player channel. The icon will turn to a green **RACING** if a channel is successfully entered.

The public channel is the yellow **PUBLIC**. Note the public channel is easily prone to interference from other devices on this channel. Change to a vacant channel.

b) Audience

Shows whether each channel is used by a player or not. The blue **PLAYER IN** means that there is a player using this channel. You can select the channel to see the camera view as a spectator.

c) Playback

Shows the videos in the specified directory of the microSD card. Select a video to play.

d) Setting

Adjust the display of the video transmission, set the parameters for the recording, the flight controller, the camera on the air unit, and more.



When linked to the remote controller, the remote controller can be used to operate the screen of the goggles.

- a) Use the right dial to scroll in the menu screen and press the right dial to confirm.
- b) Press the back button to return to the previous menu or exit the current mode.
- c) Press the record button to start or stop recording video.



- Live view will be temporarily unstable when entering Player or Audience mode as the transmission system will scan all channels.
 - The goggles can save the selected channel, so that they will enter the previous channel when restarted. The saved channel will be scanned before entering, and the goggles will enter the channel if it is not occupied. Otherwise, the goggles will enter the public channel.
 - When powering on, the devices enter the public channel by default to link. Note that before entering the saved channel, the goggles will temporarily indicate that they are in the public channel.
 - In Player mode, if an occupied channel is selected, the goggles currently occupying that channel will receive a warning prompt that another pair of goggles will occupy the channel and a countdown begins. The goggles currently occupying the channel must land the aircraft as soon as possible, as it will be set to the public channel after the countdown finishes. Once the countdown has finished, the new goggles will occupy the channel.
 - To avoid potential interference, it is not recommended to select an occupied channel. Any interference may affect image stabilization or even result in disconnection.
-

Goggles Settings

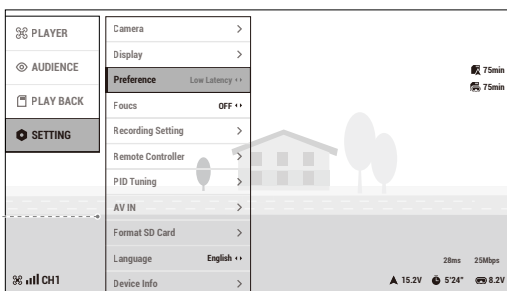
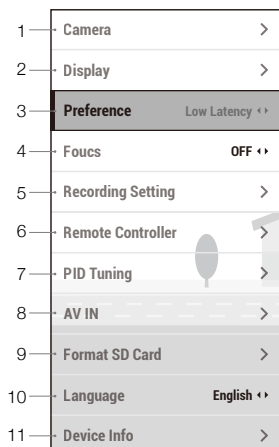

1. Camera

Set the live view ratio, scene, exposure value, saturation, white balance, or rotate the live view.

2. Display

Adjust the screen brightness, position, and zoom.

3. Preference

Select the live view mode. In Low Latency mode (720p 120fps), the latency is 18-28 ms, while in High Quality mode (720p 60fps), the latency is within 40 ms.

4. Focus Mode

Turn Focus mode on or off. If Focus mode is turned on, the center of the screen will be clearer and the edges will be blurred.

5. Recording Settings

Set the recording device and the corresponding recording format and storage mode.

6. Remote Controller

Set parameters related to the remote controller.

7. PID Tuning

Set parameters related to the flight controller.

8. AV IN

Select to enter the AV IN screen. The analog video transmission connected to the goggles will be displayed. The brightness and saturation can be adjusted.

9. Format SD Card

Format the microSD card in the air unit or the goggles. Note that the data cannot be recovered after formatting. Operate with caution.

10. Language

Select the system language.

11. Device Info

Max Power: Set the max power for the air unit.

Power Limit: If the power limit is turned on, the air unit will automatically enter low-power mode when the motors are not started. If the power limit is turned off, the air unit will transmit at max power until the temperature exceeds the operating temperature limit. Once the limit is exceeded, the air unit will restart.

Protocol: Set the protocol between the air unit and flight controller as normal (S.Bus) or DJI HDL.

Reset All: Reset the goggles and the linked air unit or remote controller to their default settings.

Device Info: View device information such as the serial number and the firmware of the goggles and the linked air unit or remote controller.



When using the DJI HDL protocol, the flight controller need to be updated to BetaFlight firmware 4.1.0 or above.

Flight Controller and Remote Controller Settings

Flight Controller

Set the PID parameters of the flight controller through the goggles.

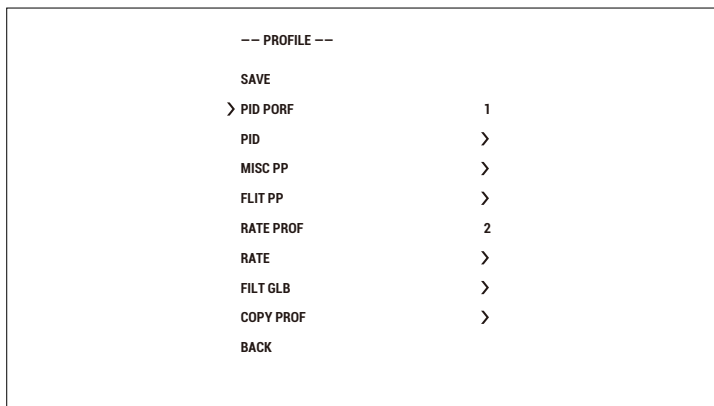

Remote Controller

Servo Setup

Set parameters for the channel range, sub-trim, reverse, and endpoint.

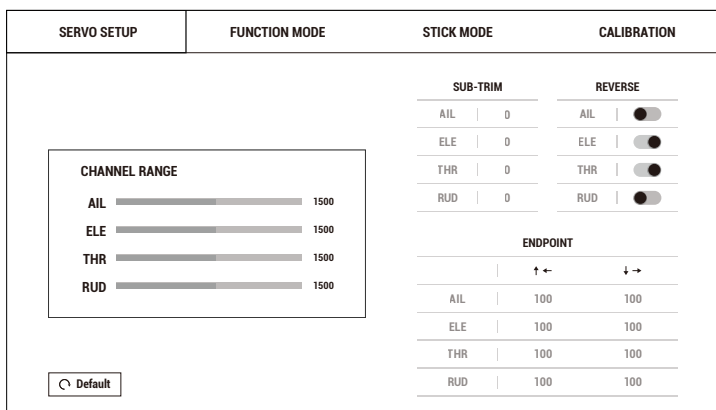

Function Mode

Select a switch for angle, arm, and flip. You can also set shortcuts for entering RC setting, FOV, and RC lock.

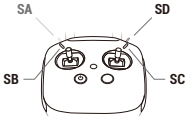
SERVO SETUP	FUNCTION MODE	STICK MODE	CALIBRATION
			
	ARM	SA	<input type="range"/>
	FLIP	SA	<input type="range"/>
	ANGLE	SA	<input type="range"/>
	Enter RC Setting	Press and Hold Right Dial	
	FOV	Left Dial and 5D Button Up/Down	
	RC Lock	Press and Hold C Button	

Stick Mode

Select Mode 1 or Mode 2.

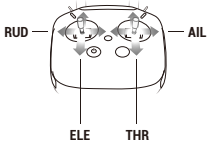
SERVO SETUP	FUNCTION MODE	STICK MODE	CALIBRATION
			
		<input checked="" type="radio"/> Mode 1	
		<input type="radio"/> Mode 2	

Calibration

Calibrate the sticks and dials of the remote controller.

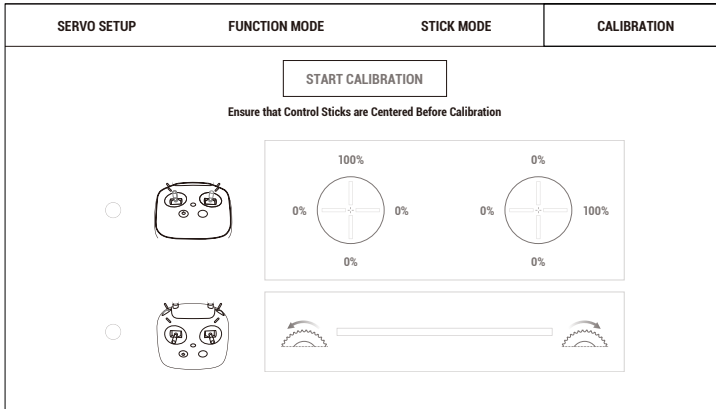

Video Recording

Make sure the DJI Digital FPV System is connected with the racing drone, and both the air unit and goggles have microSD cards inserted. Once the motors are started, the air unit and the goggles will start recording based on the recording settings. The recording will stop when the motors stop.

The recording will automatically stop when the following occurs.

Air Unit:

1. The storage mode is set to "Stop when Full" and the microSD card is full, or an error occurs during recording.
2. The temperature of the air unit is too high and enters low-power mode.

Goggles:

1. The storage mode is set to "Stop when Full" and the microSD card is full, or an error occurs during recording.
2. The transmission is disconnected, or the transmission signal is lost.
3. The live view source is changed, such as switching between Player to Audience mode or changing a channel in Audience mode.
4. Exit live view, such as entering the RC setting or AV IN.
5. The temperature of the air unit is too high and enters low-power mode.

Powering off the device or removing the microSD card during recording will result in a corrupted video file, which cannot be played. Insert the microSD card into the device again, power on, and the device will attempt to recover the corrupted video file automatically.

Updating Firmware

Use DJI Assistant 2 to update the air unit, goggles, or remote controller separately.

1. Power on the device and connect it to a computer with a USB-C cable.
2. Launch DJI Assistant 2 and login with a registered DJI account.
3. Select the device and click "Firmware Update" on the left-hand side.
4. Select the firmware version required.
5. DJI Assistant 2 will download and update the firmware automatically.
6. Restart the device after the firmware update is complete.

 Make sure that the device has sufficient power before updating firmware.

Maintenance

DJI FPV Goggles

Cleaning

Make sure to disconnect the goggles from the power outlet before cleaning and make sure that there are no cables connected.

Clean the surface of the goggles with a soft, dry clean cloth. To clean the foam padding, moisten the cloth with clean water, and wipe the foam padding.

Replacing the Foam Padding

The foam padding is attached to the goggles with Velcro. When replacing the foam padding, peel it gradually from the left or right side. Align the new foam padding with the goggles and then press the foam padding down so it is securely attached.

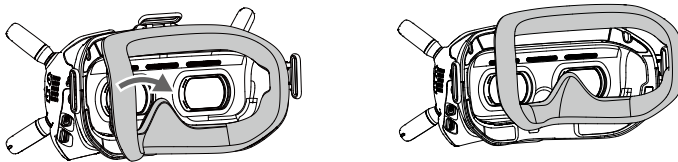

Maintenance of Lenses

Use a cleaning cloth to wipe the lenses gently.

1. Moisten the cleaning cloth with alcohol or a lens cleaner.
2. Wipe in a circular motion from the center to the outer edges of the lenses.

 • DO NOT clean the foam padding with alcohol.

- The lenses are delicate. Clean them gently. DO NOT scratch them as this will damage the overall viewing experience.
- Store the goggles in a dry room at room temperature to avoid damage to the lenses from high temperature and humid environments.

DJI FPV Air Unit

When replacing components of the air unit such as the air unit module, camera, or coaxial cable, follow the steps below to disassemble and install.

Air Unit Module End

1. Loosen the two screws on the back cover of the air unit module, then remove the back cover.

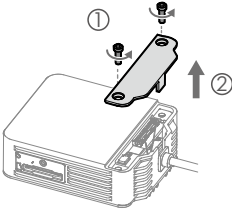

2. Use an appropriate tool (such as a paper clip) to lift one side of the plug, and then remove the coaxial cable from the air unit module.

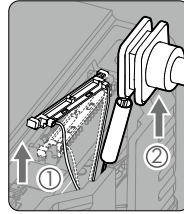

3. Remove the component that needs to be replaced and prepare the new component.

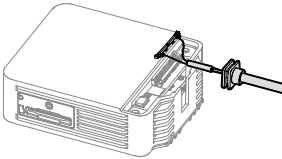

4. Align the plug with the connector on the air unit, press the plug down to make sure they are securely connected. Insert the coaxial cable holder into the slot of the air unit module.

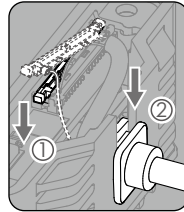

5. Make sure the coaxial cable is inserted properly.

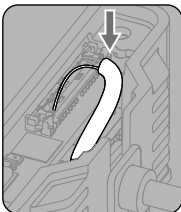

6. Mount the back cover of the air unit module and tighten the screws.

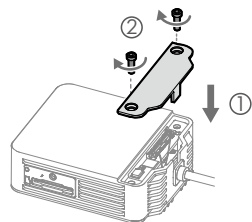

Camera End

1. Loosen the two screws on the back cover of the camera, then remove the back cover.

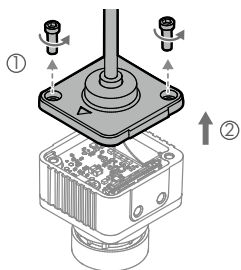

2. Use an appropriate tool (such as a paper clip) to lift one side of the plug to remove the coaxial cable.

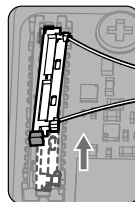

3. Remove the component that needs to be replaced and prepare the new component.

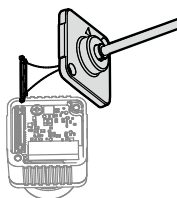

4. Align the plug with the connector on the camera and press it down to make sure they are securely connected.

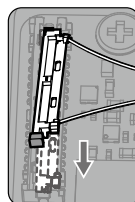

5. Mount the back cover of the camera and tighten the screws.

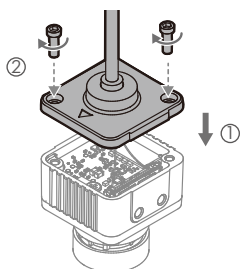

Specifications

DJI FPV Air Unit

Weight	Air Unit (camera included): 45.8 g Antenna: 3.74 g (MMCX straight); 3.9 g (MMCX elbow); 6 g (reverse polarity female SMA)
Dimensions	Air Unit: 44×37.8×14.4 mm Camera: 27.4×21.1×20.1 mm Coaxial Cable: 100 mm Antenna: 12.7×12.7×80 mm (MMCX straight); 12.7×12.7×80 mm (MMCX elbow); 12.7×12.7×55 mm (reverse polarity female SMA)
Operating Frequency	5.725-5.850 GHz
Transmitter Power (EIRP)	FCC/SRRC: < 30 dBm; CE: < 14 dBm
Min. Latency (end-to-end)	Low Latency Mode (720p 120fps): <28 ms; High Quality Mode (720p 60fps): <40 ms
Max. Transmission Distance	FCC/SRRC: 4 km; CE: 0.7 km
Video Format	MP4 (Video format: H.264; Audio format: AAC-LC)
Video Resolution	1080p 60fps, 720p 120fps
I/O Interface	USB-C, MMCX, 3-in-1 port, microSD card slot
Supported Flight Controller System	BetaFlight
Operating Temperature Range	0° to 40° C (32° to 104° F)
Input Power	7.4-17.6 V
Camera	Sensor: 1/3.2" CMOS; Effective Pixels: 4 M Lens: 2.1 mm, f/2.1 Shutter: Rolling shutter ISO: 100-25600 FOV: 150° (D); 122° (H); 93° (V)

DJI FPV Goggles

Weight	Approx. 415 g (headband and antennas included)
Dimensions	184×122×110 mm (antennas excluded); 202×126×110 mm (antennas included)
Screen Size	2-inch x 2
Screen Resolution (Single Screen)	1440×810
Refresh Rate	120 Hz
FOV	85° (Single Screen)
Interpupillary Distance Range	58-70 mm
Communication Frequency	5.725-5.850 GHz
Transmitter Power (EIRP)	FCC: <30 dBm; CE: <14 dBm; SRRC: <19 dBm
Live View Mode	Low Latency Mode (720p 120fps); High Quality Mode (720p 60fps)
Video Format	MP4 (Video format: H.264)
Resolution	720p 60fps

Supported Video Play Format	MP4, MOV, MKV (Video format: H.264; Audio format: AAC-LC, AAC-HE, AC-3, MP3)
I/O Interface	USB-C, reverse polarity SMA, DC5.5x2.1, 3.5 mm audio port, microSD card slot
Operating Temperature	0° to 40° C (32° to 104° F)
Power Input	7.4-17.6 V

DJI FPV Remote Controller

Remote Controller	
Weight	765 g
Operating Frequency	5.725-5.850 GHz
Max. Transmission Distance (unobstructed, free of interference)	FCC/SRRC: 4 km; CE: 0.7 km
Transmitter Power (EIRP)	FCC: <30 dBm; CE: <14 dBm; SRRC: <19 dBm
Operating Current/Voltage	0.6 A @ 7.6 V
Operating Temperature	0° to 40° C (32° to 104° F)
Charging Temperature	5° to 40° C (41° to 104° F)
Remote Controller Intelligent Battery (WB37-4920mAh-7.6V)	
Battery Type	LiPo 2S
Capacity 4920 mAh	4920 mAh
Voltage	7.6 V
Energy	37.39 Wh

DJI Support

<https://www.dji.com/support>

This content is subject to change.

Download the latest version from

<https://www.dji.com/fpv>

If you have any questions about this document, please contact DJI by sending a message to DocSupport@dji.com.

Copyright © 2019 DJI All Rights Reserved.