

dji FLIP

User Manual

v1.0 2025.01

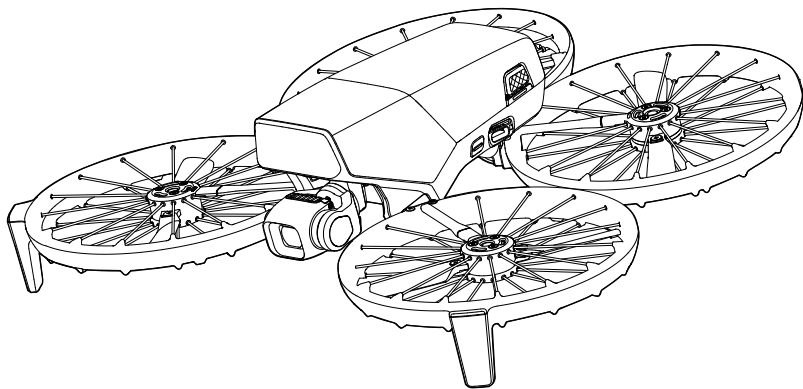



This document is copyrighted by DJI with all rights reserved. Unless otherwise authorized by DJI, you are not eligible to use or allow others to use the document or any part of the document by reproducing, transferring or selling the document. Only refer to this document and the content thereof as instructions to operate DJI products. The document should not be used for other purposes.

In the event of divergence among different versions, the English version shall prevail.

Searching for Keywords

Search for keywords such as “battery” and “install” to find a topic. If you are using Adobe Acrobat Reader to read this document, press Ctrl+F on Windows or Command+F on Mac to begin a search.

Navigating to a Topic

View a complete list of topics in the table of contents. Click on a topic to navigate to that section.

Printing this Document

This document supports high resolution printing.

Using this Manual

Legend

⚠ Important

💡 Hints and Tips

📖 Reference

Read Before Use

DJI™ provides you with tutorial videos and the following documents:

1. *Safety Guidelines*
2. *Quick Start Guide*
3. *User Manual*

It is recommended to watch all the tutorial videos and read the *Safety Guidelines* before using for the first time. Make sure to review the *Quick Start Guide* before using for the first time and refer to this *User Manual* for more information.

Video Tutorials

Go to the address below or scan the QR code to watch the tutorial videos, which demonstrate how to use the product safely:



<https://www.dji.com/flip/video>

Download the DJI Fly App

Make sure to use DJI Fly during flight. Scan the QR code to download the latest version.



-  The remote controller with screen has the DJI Fly app already installed. You are required to download DJI Fly to your mobile device when using the remote controller without screen.
 - To check the Android and iOS operating system versions supported by DJI Fly, visit <https://www.dji.com/downloads/djiapp/dji-fly>.
 - The interface and functions of DJI Fly may vary as the software version is updated. Actual user experience is based on the software version used.
-
- * For increased safety, flight is restricted to a height of 98.4 ft (30 m) and a range of 164 ft (50 m) when not connected or logged into the app during flight. This applies to DJI Fly and all apps compatible with DJI aircraft.

Download DJI Assistant 2

Download DJI ASSISTANT™ 2 (Consumer Drones Series) at:

<https://www.dji.com/downloads/software/dji-assistant-2-consumer-drones-series>

-  The operating temperature of this product is -10° to 40° C. It does not meet the standard operating temperature for military-grade application (-55° to 125° C), which is required to endure greater environmental variability. Operate the product appropriately and only for applications that meet the operating temperature range requirements of that grade.
-

Contents

Using this Manual	3
Legend	3
Read Before Use	3
Video Tutorials	3
Download the DJI Fly App	3
Download DJI Assistant 2	4
1 Product Profile	10
1.1 Using for the First Time	10
Preparing the Aircraft	10
Preparing the Remote Controller	12
DJI RC 2	12
DJI RC-N3	13
Activation	13
Firmware Update	14
1.2 Overview	14
Aircraft	14
DJI RC 2 Remote Controller	15
DJI RC-N3 Remote Controller	16
2 Flight Safety	18
2.1 Flight Restrictions	18
GEO (Geospatial Environment Online) System	18
Flight Limits	18
Flight Altitude and Distance Limits	18
GEO Zones	20
Unlocking GEO Zones	20
2.2 Flight Environment Requirements	20
2.3 Operating the Aircraft Responsibly	22
2.4 Pre-Flight Checklist	22
3 Flight Operation	25
3.1 Palm Control	25
Notice	25
Switching Modes	27
Palm Takeoff/Landing and Smart Snaps	28
3.2 Mobile App Control	30
Notice	30
Connecting DJI Flip	31
3.3 RC Control	31

Auto Takeoff	31
Auto Landing	32
Starting/Stopping the Motors	32
Starting the Motors	32
Stopping the Motors	32
Stopping the Motors Mid-Flight	33
Controlling the Aircraft	33
Takeoff/Landing Procedures	34
Intelligent Flight Modes	34
FocusTrack	35
MasterShots	36
QuickShots	37
Hyperlapse	38
Cruise Control	39
Recording Audio via App	39
3.4 Video Suggestions and Tips	40
4 Aircraft	42
4.1 Flight Mode	42
4.2 Aircraft Status Indicators	43
4.3 Return to Home	43
Notice	44
Trigger Method	45
RTH Procedure	46
4.4 Auto Landing	47
Trigger Method	47
Landing Protection	47
4.5 Sensing System	48
Notice	49
4.6 Propellers	50
Notice	51
Replacing the Propellers	52
4.7 Intelligent Flight Battery	54
Notice	54
Installing/Removing the Battery	55
Using the Battery	55
Charging the Battery	57
Using a Charger	57
Using the Charging Hub	57
Battery Protection Mechanisms	62
4.8 Gimbal and Camera	62
Gimbal Notice	62

	Gimbal Operation Modes	63
	Gimbal Angle	63
	Camera Notice	63
4.9	Storing and Exporting Photos and Videos	64
	Storing	64
	Exporting	64
4.10	QuickTransfer	65
5	Remote Controller	67
5.1	DJI RC 2	67
	Operations	67
	Powering On/Off	67
	Charging the Battery	67
	Controlling the Gimbal and Camera	68
	Flight Mode Switch	68
	Flight Pause/RTH Button	68
	Customizable Buttons	69
	Remote Controller LEDs	69
	Status LED	69
	Battery Level LEDs	70
	Remote Controller Alert	70
	Optimal Transmission Zone	70
	Linking the Remote Controller	71
	Operating the Touchscreen	71
5.2	DJI RC-N3	73
	Operations	73
	Powering On/Off	73
	Charging the Battery	73
	Controlling the Gimbal and Camera	73
	Flight Mode Switch	74
	Flight Pause/RTH Button	74
	Customizable Button	74
	Battery Level LEDs	74
	Remote Controller Alert	75
	Optimal Transmission Zone	75
	Linking the Remote Controller	76
6	Appendix	78
6.1	Specifications	78
6.2	Compatibility	78
6.3	Firmware Update	78
6.4	Flight Recorder	79

6.5	Post-Flight Checklist	79
6.6	Maintenance Instructions	79
6.7	Troubleshooting Procedures	80
6.8	Risks and Warnings	81
6.9	Disposal	81
6.10	C0 Certification	82
	Remote Controller Warnings	83
	EASA Notice	83
	Original Instructions	83
6.11	Aftersales Information	84

Product Profile

1 Product Profile

1.1 Using for the First Time



Click the link or scan the QR code to watch the tutorial videos.



<https://www.dji.com/flip/video>

Preparing the Aircraft

1. Press both the left and right sides to remove the gimbal protector. Remove and throw away the disposable rubber cover.

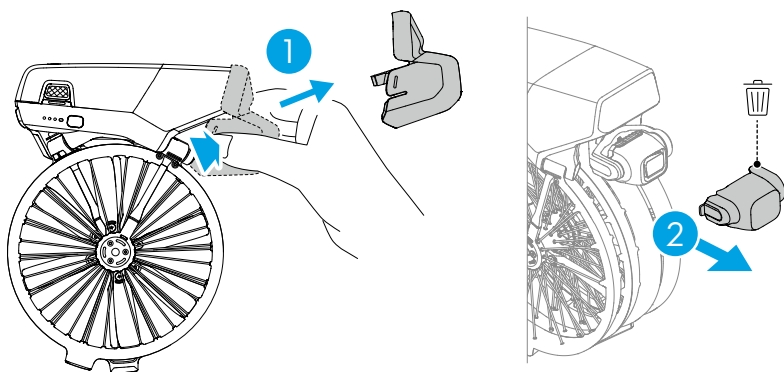

⚠ • The disposable rubber cover cannot be reused.

2. Charge to activate the battery until the battery level LEDs are on.

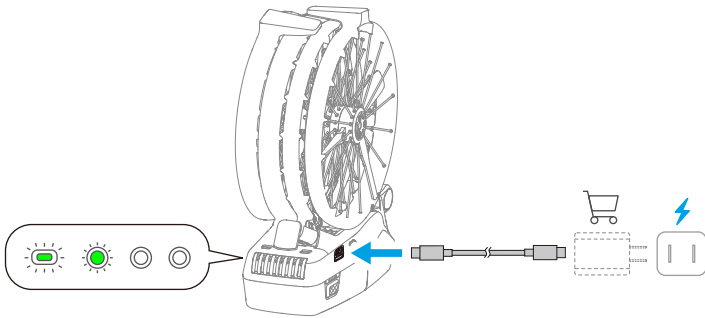

3. Unfold the front arms and rear arms as shown.

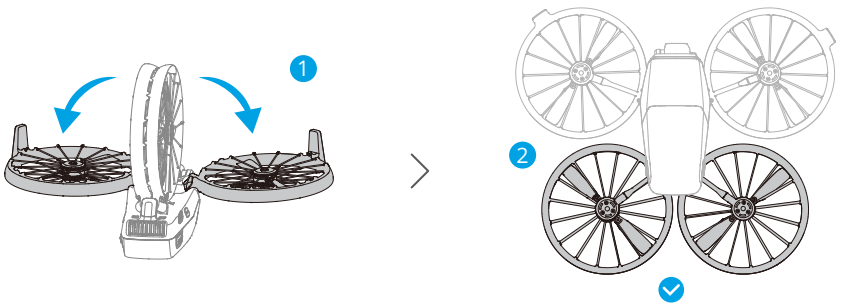

- **Automatic Power-On:** Unfolding either one of the rear arms will power on the aircraft by default.
- **Automatic Power-Off:** Folding both rear arms will initiate an automatic countdown for power-off. During the countdown, a press of any button on the aircraft body can cancel the power-off.
- **Manual Power-On/Power-Off:** Press, then press and hold the power button to power on or off the aircraft.

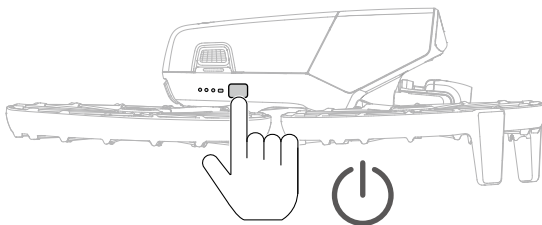

- The Unfold/Fold Arm for Auto on/off feature is enabled by default. You can disable the feature in DJI Fly when the aircraft is connected to a

remote controller. Update the aircraft firmware and the DJI Fly app to the latest version. Otherwise, the feature may not be available.

- If the aircraft is currently accessing the album, downloading materials, or updating firmware, folding both rear arms will not power off the aircraft.
- If a collision occurs during the current flight, the automatic power-off feature will not function for this flight.



- Make sure the gimbal protector is removed and all arms are unfolded before powering on the aircraft. Otherwise, it may affect the aircraft self-diagnostics.
 - It is recommended to attach the gimbal protector when the aircraft is not in use.
-

Preparing the Remote Controller

DJI RC 2

1. Remove the control sticks from the storage slots and mount them on the remote controller.

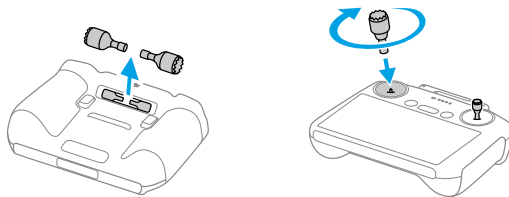

2. Unfold the antennas.

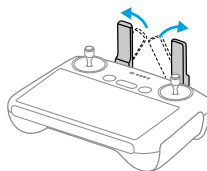

3. The remote controller needs to be activated before first use and an internet connection is required for activation. Press, then press and hold the power button to power on the remote controller. Follow the on-screen prompts to activate the remote controller.

DJI RC-N3

1. Remove the control sticks from the storage slots and mount them on the remote controller.
2. Pull out the mobile device holder. Choose the appropriate remote controller cable based on the port type of your mobile device (the cable with a USB-C connector is connected by default). Place your mobile device in the holder, then connect the end of the cable without the remote controller logo to your mobile device. Make sure your mobile device is securely in place.

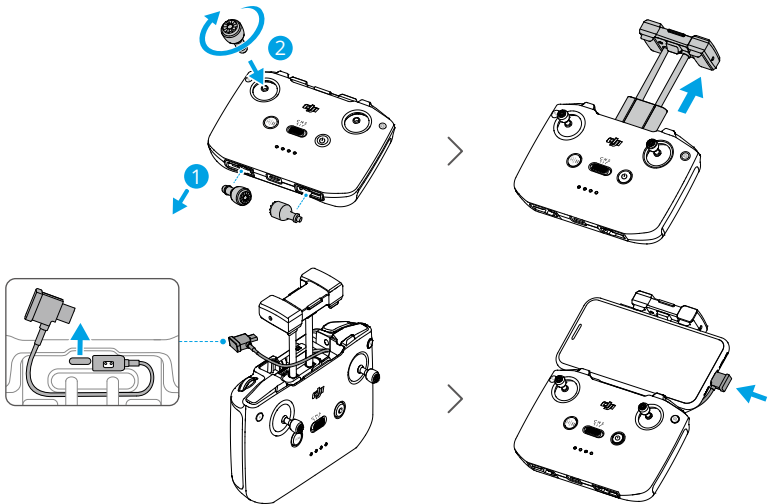

- If a USB connection prompt appears when an Android mobile device is used, select the option to charge only. Other options may cause the connection to fail.
- Adjust the mobile device holder to make sure your mobile device is firmly secure.

Activation

The aircraft requires activation before first use. Press, then press and hold the power button to power on the aircraft and remote controller respectively, and then follow the onscreen prompts to activate the aircraft using DJI Fly. An internet connection is required for activation.

Firmware Update

A prompt will appear in DJI Fly when a firmware update is available. Update the firmware whenever prompted to ensure the optimal user experience.

1.2 Overview

Aircraft

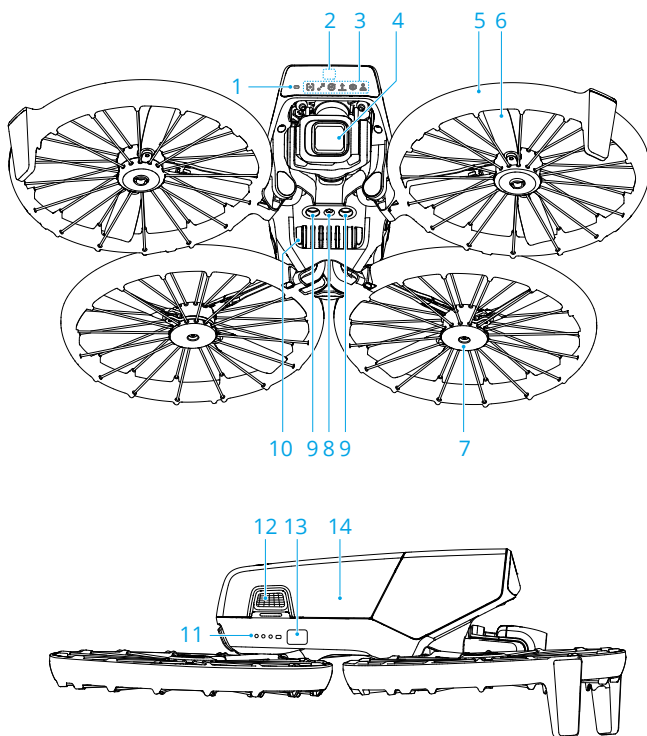

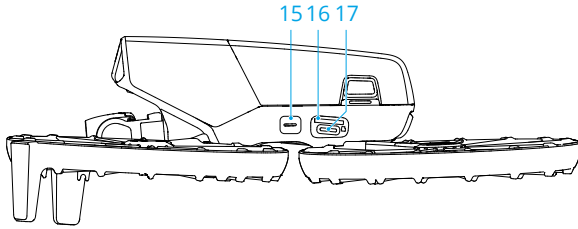

- | | |
|--|-------------------------------------|
| 1. Aircraft Status Indicator | 9. Downward Infrared Sensing System |
| 2. Forward Three-Dimensional Infrared Sensing System | 10. Speaker |
| 3. Mode Indicators | 11. Battery Level LEDs |
| 4. Gimbal Camera | 12. Battery Buckles |
| 5. Aircraft Arms | 13. Power Button |
| 6. Propellers | 14. Intelligent Flight Battery |
| 7. Motors | 15. Mode Button |
| 8. Downward Vision System | 16. microSD Card Slot |
| | 17. USB-C Port |

DJI RC 2 Remote Controller

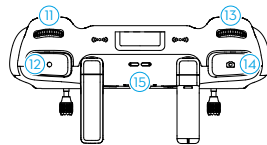
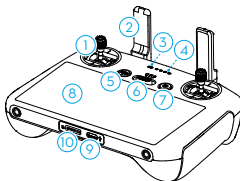

- | | |
|---|---------------------------------|
| 1. Control Sticks | 10. microSD Card Slot |
| 2. Antennas | 11. Gimbal Dial |
| 3. Status LED | 12. Record Button |
| 4. Battery Level LEDs | 13. Camera Control Dial |
| 5. Flight Pause/Return to Home (RTH) Button | 14. Focus/Shutter Button |
| 6. Flight Mode Switch | 15. Speaker |
| 7. Power Button | 16. Control Stick Storage Slots |
| 8. Touchscreen | 17. Customizable C2 Button |
| 9. USB-C Port | 18. Customizable C1 Button |

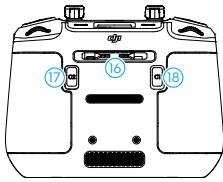

DJI RC-N3 Remote Controller

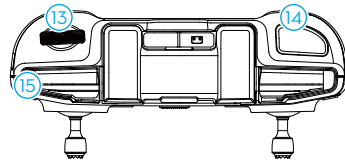
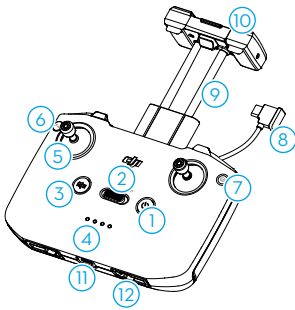

- | | |
|---|---------------------------------|
| 1. Power Button | 8. Remote Controller Cable |
| 2. Flight Mode Switch | 9. Mobile Device Holder |
| 3. Flight Pause/Return to Home (RTH) Button | 10. Antennas |
| 4. Battery Level LEDs | 11. USB-C Port |
| 5. Control Sticks | 12. Control Stick Storage Slots |
| 6. Customizable Button | 13. Gimbal Dial |
| 7. Photo/Video Button | 14. Shutter/Record Button |
| | 15. Mobile Device Slot |

Flight Safety

2 Flight Safety

After completing pre-flight preparations, it is recommended to train your flying skills and practice flying safely. Pick a suitable area to fly in according to the following flight requirements and restrictions. Strictly abide by local laws and regulations when flying. Read the *Safety Guidelines* before flight to ensure safe use of the product.

2.1 Flight Restrictions

GEO (Geospatial Environment Online) System

The DJI Geospatial Environment Online (GEO) System is a global information system that provides real-time information on flight safety and restriction updates and prevents UAVs from flying in restricted airspace. Under exceptional circumstances, restricted areas can be unlocked to allow flights. Prior to that, you must submit an unlocking request based on the current restriction level in the intended flight area. The GEO system may not fully align with local laws and regulations. You are responsible for your own flight safety and must consult with the local authorities on the relevant legal and regulatory requirements before requesting to unlock a restricted area. For more information about the GEO system, visit <https://fly-safe.dji.com>.

Flight Limits

For safety reasons, flight limits are enabled by default to help you operate the aircraft safely. You can set flight limits on height and distance. Altitude limits, distance limits, and GEO zones function concurrently to manage flight safety when Global Navigation Satellite System (GNSS) is available. Only altitude can be limited when GNSS is unavailable.

Flight Altitude and Distance Limits

Max altitude restricts the flight altitude of the aircraft, while max distance restricts the flight radius around the Home Point of the aircraft. These limits can be changed in the DJI Fly app for improved flight safety.

-
- When using Palm Control and Mobile App Control, the max flight altitude is 30 m and the max flight distance is 50 m. These limits can not be changed in the DJI Fly app. The following information is suitable for when using the aircraft with the remote control devices.
-

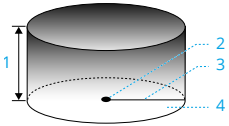

1. Max Altitude
2. Home Point (Horizontal Position)
3. Max Distance
4. Height of aircraft when taking off

Strong GNSS Signal

	Flight Restrictions	Prompt in DJI Fly App
Max Altitude	Altitude of the aircraft cannot exceed the value set in DJI Fly.	Max flight altitude reached.
Max Distance	The straight-line distance from the aircraft to the Home Point cannot exceed the max flight distance set in DJI Fly.	Max flight distance reached.

Weak GNSS Signal

	Flight Restrictions	Prompt in DJI Fly App
Max Altitude	<ul style="list-style-type: none"> • Altitude is restricted to 30 m from the takeoff point if lighting is sufficient. • Altitude is restricted to 2 m above the ground if lighting is not sufficient and the infrared sensing system is functioning. • Altitude is restricted to 30 m from the takeoff point if lighting is not sufficient and the infrared sensing system is not functioning. 	Max flight altitude reached.
Max Distance	No limit	

- ⚠ • Each time the aircraft is powered on, the altitude limit of 2 m or 30 m will be automatically removed as long as the GNSS signal becomes strong (GNSS signal strength ≥ 2), and the limit will not take effect even if the GNSS signal becomes weak afterwards.
- If the aircraft flies out of the set flight range due to inertia, you can still control the aircraft but cannot fly it any further away.

GEO Zones

The DJI GEO system designates safe flight locations, provides risk levels and safety notices for individual flights, and offers information on restricted airspace. All restricted flight areas are referred to as GEO Zones, which are further divided into Restricted Zones, Authorization Zones, Warning Zones, Enhanced Warning Zones, and Altitude Zones. You can view such information in real-time in DJI Fly. GEO Zones are specific flight areas, including but not limited to airports, large event venues, locations where public emergencies have occurred (such as forest fires), nuclear power plants, prisons, government properties, and military facilities. By default, the GEO system limits takeoffs and flights in zones that may cause safety or security concerns. A GEO Zone map that contains comprehensive information on GEO Zones around the globe is available on the official DJI website: <https://fly-safe.dji.com/nfz/nfz-query>.

Unlocking GEO Zones

To satisfy the needs of different users, DJI provides two unlocking modes: Self-Unlocking and Custom Unlocking. You can make a request on the DJI Fly Safe website.

Self-Unlocking is intended for unlocking Authorization Zones. To complete Self-Unlocking, you must submit an unlocking request via the DJI Fly Safe website at <https://fly-safe.dji.com>. Once the unlocking request is approved, you can synchronize the unlocking license through the DJI Fly app. To unlock the zone, alternatively, you can launch or fly the aircraft directly into the approved Authorization Zone and follow the prompts in DJI Fly to unlock the zone.

Custom Unlocking is tailored for users with special requirements. It designates user-defined custom flight areas and provides flight permission documents specific to the needs of different users. This unlocking option is available in all countries and regions and can be requested via the DJI Fly Safe website at <https://fly-safe.dji.com>.

-
-  • To ensure flight safety, the aircraft will not be able to fly out of the unlocked zone after entering it. If the Home Point is outside the unlocked zone, the aircraft will not be able to return home.
-

2.2 Flight Environment Requirements

1. DO NOT fly in severe weather conditions such as strong winds, snow, rain, and fog.
2. Only fly in open areas. Tall buildings and large metal structures may affect the accuracy of the onboard compass and GNSS system. Therefore, DO NOT take off from a balcony or anywhere within 15 m of buildings. Keep a distance of at least 15 m from buildings during flight. After takeoff, make sure you are notified with the

prompt “Home Point is updated” before continuing flight. If the aircraft has taken off near buildings, the accuracy of the Home Point cannot be guaranteed. In this case, pay close attention to the current position of the aircraft during auto RTH. When the aircraft is close to the Home Point, it is recommended to cancel auto RTH and manually control the aircraft to land at an appropriate location.

3. Fly the aircraft within visual line of sight (VLOS). Avoid mountains and trees blocking GNSS signals. Avoid obstacles, crowds, trees, and bodies of water (recommended height is at least 6 m above water). For safety reasons, DO NOT fly the aircraft near airports, highways, railway stations, railway lines, city centers, or other sensitive areas, unless any permit or approval is obtained under local regulations.
4. When the GNSS signal is weak, fly the aircraft in environments with good lighting and visibility. The vision system may not work properly in poor light conditions. Only fly the aircraft in the daytime.
5. Minimize interference by avoiding areas with high levels of electromagnetism, such as locations near power lines, base stations, electrical substations, and broadcasting towers.
6. The performance of the aircraft and its battery is limited when flying at high altitudes. Fly with caution. DO NOT fly above the specified altitude.
7. The braking distance of the aircraft is affected by the flight altitude. The higher the altitude, the greater the braking distance. When flying at high altitudes, you should reserve adequate braking distance to ensure flight safety.
8. GNSS cannot be used on the aircraft in polar regions. Use the vision system instead.
9. DO NOT take off from moving objects such as cars, ships, and airplanes.
10. DO NOT take off from solid-colored surfaces or surfaces with strong reflections such as a car roof.
11. DO NOT take off from or land on surfaces with sand such as deserts or beaches. DO NOT take off or land on grass or surfaces with fallen leaves or other small, lightweight matter. This is to prevent sand, grass, leaves and other foreign matter from entering aircraft parts and causing damage to the motors, gimbal, or propellers.
12. DO NOT operate the aircraft in an environment at risk of a fire or explosion.
13. Operate the aircraft, remote controller, battery, battery charger, and battery charging hub in a dry environment.
14. DO NOT use the aircraft, remote controller, battery, battery charger, and the battery charging hub near accidents, fire, explosions, floods, tsunamis, avalanches, landslides, earthquakes, dust, sandstorms, salt spray, or fungus.
15. DO NOT operate the aircraft near bird flocks.

2.3 Operating the Aircraft Responsibly

To avoid serious injury and property damage, observe the following rules:

1. Make sure you are NOT under the influence of anesthesia, alcohol, or drugs or suffering from dizziness, fatigue, nausea, or other conditions that could impair the ability to operate the aircraft safely.
2. After landing, power off the aircraft first, then switch off the remote controller.
3. DO NOT drop, launch, fire, or otherwise project any dangerous payloads on or at any buildings, persons, or animals, which could cause personal injury or property damage.
4. DO NOT use an aircraft that has been accidentally damaged, crashed, or is not in good condition.
5. Make sure to train sufficiently and have contingency plans for emergencies or if an incident occurs.
6. Make sure to have a flight plan. DO NOT fly the aircraft recklessly.
7. Respect the privacy of others when using the camera. Make sure to comply with local privacy laws, regulations, and moral standards.
8. DO NOT use this product for any reason other than general personal use.
9. DO NOT use it for illegal or inappropriate purposes such as spying, military operations, or unauthorized investigations.
10. DO NOT use this product to defame, abuse, harass, stalk, threaten, or otherwise violate legal rights such as the right to privacy and publicity of others.
11. DO NOT trespass onto the private property of others.

2.4 Pre-Flight Checklist

1. Remove any protective parts from the aircraft.
2. Make sure the Intelligent Flight Battery and the propellers are mounted securely.
3. Make sure the remote controller, mobile device, and Intelligent Flight Battery are fully charged.
4. Make sure the aircraft arms are unfolded.
5. Make sure the gimbal and camera are functioning normally.
6. Make sure that there is nothing obstructing the motors and that they are functioning normally.
7. Make sure that DJI Fly is successfully connected to the aircraft.
8. Make sure all camera lenses and sensors are clean.

9. Only use genuine DJI parts or DJI-authorized parts. Unauthorized parts may cause system malfunctions and compromise flight safety.
10. Make sure the **Obstacle Avoidance Action** is set in DJI Fly, and the **Max Altitude**, **Max Distance** and **Auto RTH Altitude** are all set properly according to local laws and regulations.

Flight Operation

3 Flight Operation

DJI Flip supports multiple control methods for various scenarios to meet your needs. Make sure you are familiar with the notice and usage for each control method before flight.

-
- ⚠ • DO NOT touch DJI Flip mid-flight. Otherwise, DJI Flip may drift and a collision may occur.
 - DO NOT fly DJI Flip immediately after it has been in a collision or severely knocked or shaken. DJI Flip may not be able to perform stable flight.
-

3.1 Palm Control



It is recommended to click the link below or scan the QR code to watch the tutorial video.



<https://www.dji.com/flip/video>

In Palm Control, palm takeoff and landing is supported. You can use the mode button on DJI Flip to achieve multiple Smart Snaps. DJI Flip will fly while recording automatically after subject confirmation. Connect to the DJI Fly app using the Wi-Fi function to adjust the parameters for each mode. The default settings are used as an example.

Notice

-
- 💡 • Power off the remote control devices connected to the aircraft before using Palm Control.
-
- ⚠ • Make sure that the flight environment meets the flight requirements and that you can control and retrieve DJI Flip immediately when an issue occurs or in an emergency. In situations where DJI may not be able to analyze the cause of the incident, it may not be possible for DJI to provide warranty and other aftersales services.
 - Before using Palm Control, make sure that DJI Flip has previously connected to DJI Fly on your smartphone via Wi-Fi. When using Palm Control without the app,

if DJI Flip malfunctions mid-flight, you can choose to connect it to DJI Fly via Wi-Fi and control it manually to avoid an accident.

- Make sure to fly in an open and unobstructed environment without signal interference.
- When using Palm Control, the max flight altitude of DJI Flip is 30 m and the max flight distance is 50 m.
- Return to Home (RTH) is not supported in Palm Control. Maintain visual line of sight (VLOS) within a controlled area.
- DO NOT fly over water.
- DJI Flip will land automatically in the following situations. Make sure to observe the operating environment to avoid DJI Flip being lost or damaged due to the landing.
 - Critical low battery.
 - Positioning fails and DJI Flip enters Attitude mode.
 - DJI Flip detects a collision but does not crash.
- Observe the following rules when taking off from or landing on the palm of your hand:
 - Operate DJI Flip in a windless environment whenever possible.
 - **Hold the sides of the aircraft body from below when taking off. DO NOT place your fingers within the rotation range of the propellers. If taking off from the open palm of your hand, make sure to fully extend your fingers to avoid touching the propellers.**
 - DO NOT perform takeoff or landing when moving. Otherwise, DJI Flip may drift and a collision may occur. During landing, DJI Flip may fail to stop the motors when your hand is moving.
 - DO NOT throw DJI Flip during takeoff.
 - DO NOT grab DJI Flip by hand.
 - To land on your palm, place your hand right under DJI Flip to prevent it from falling after landing.
 - **When landing, place you hand underneath the aircraft and wait for the aircraft to land. Make sure to fully extend your fingers to avoid touching the propellers. DO NOT attempt to grab the sides of the aircraft body during landing in the same manner as during takeoff.**
 - Take off in an environment with sufficient lighting and a richly textured surface. DO NOT fly to an environment that has a significant difference in lighting from the current location.

- If DJI Flip fails to perform palm takeoff or landing, follow the voice prompt of DJI Flip for troubleshooting or connect to the DJI Fly app for details. **Voice prompt supports English or Mandarin according to the app language setting for the latest connection. Other languages are not supported.**

Switching Modes





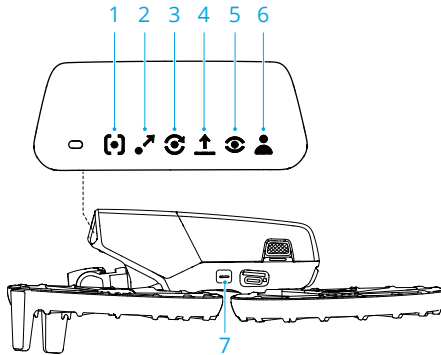

Press the mode button once to switch mode.

After switching the mode, DJI Flip will voice prompt the selected mode, and the corresponding mode indicator will light up.

Press and hold to perform palm takeoff.

Cancel palm takeoff by pressing the mode button once before the countdown voice prompt ends.



1.  Follow
2.  Dronie
3.  Circle
4.  Rocket
5.  Spotlight
6.  Custom
 - DirectionTrack
 - Helix
 - Boomerang
7. Mode Button

Palm Takeoff/Landing and Smart Snaps

- ⚠️ • Make sure to follow local privacy laws and regulations when using Smart Snaps.
- Smart Snaps only supports the tracking of people.
- Palm takeoff and landing are supported for palm control, mobile app control, and RC control. The difference is that when using RC control, Smart Snaps for palm control are not supported, and subject confirmation is not required before takeoff.

1. Power on DJI Flip. Keep it still and wait for the system self-diagnostics to complete.
2. Make sure to leave enough room for maneuvering according to the preset parameters such as distance and height. Press the mode button to select your desired mode.
3. Follow the steps below for palm takeoff.

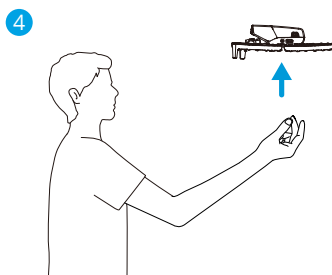
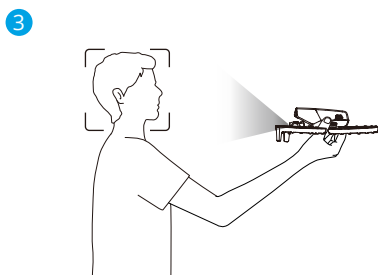
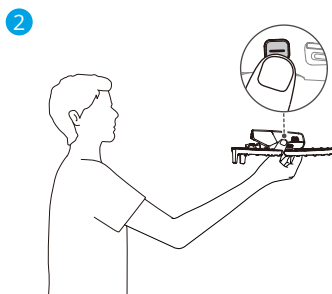
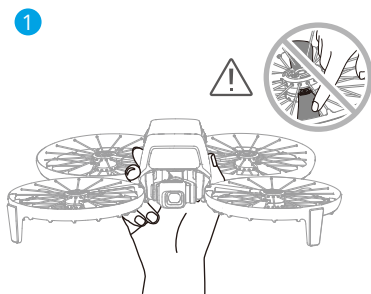

- a. Palm takeoff requires subject confirmation. Hold the sides of the aircraft body from below with the camera facing the subject. Make sure that your hand does not block the camera and there are no obstacles obstructing the takeoff.

- ⚠️ • DO NOT place your fingers within the rotation range of the propellers!

- b. Extend your arm, face the camera toward the subject, and keep it steady. Press and hold the mode button. DJI Flip will voice prompt the selected mode and the countdown, and then take off automatically.

- 💡 • When the subject is obstructed by an obstacle or the environment lighting is not suitable, takeoff may fail.
- To cancel palm takeoff, press the mode button once before the countdown voice prompt ends.
- When using palm takeoff, DJI Flip will fly backward for a short distance after takeoff. Pay attention to the rear of DJI Flip to ensure flight safety.

4. DJI Flip will start recording or take photos according to the selected mode and its preset parameters.

5. Palm landing:

In DirectionTrack mode, face DJI Flip and keep still. Wait for DJI Flip to fly forward before performing palm landing.

In other modes, make sure that DJI Flip is hovering in place, move toward it, and then perform palm landing.

Follow the instructions below for palm landing.

- a. Make sure that DJI Flip is hovering in place. Move toward DJI Flip, extend your arm, and then place your hand right under it.
- b. Keep your hand still. Make sure to fully extend your fingers to avoid touching the propellers. Wait for DJI Flip to land automatically.

- ⚠️ • When landing, place your hand underneath the aircraft and wait for the aircraft to land. Make sure to fully extend your fingers to avoid touching the propellers. **DO NOT** attempt to grab the sides of the aircraft body during landing in the same manner as during takeoff.

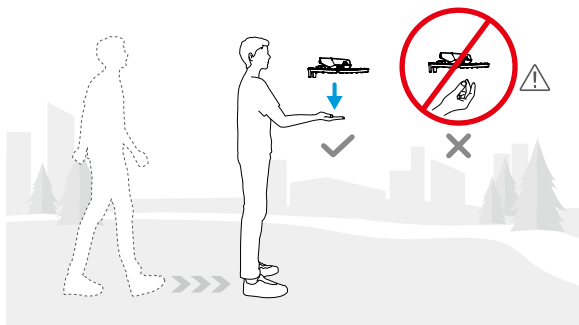

- During palm landing, DJI Flip may ascend slightly and then land on the palm. Keep your hand still and extend your fingers during the process.
-

6. Connect DJI Flip to DJI Fly to view the footage and create short videos.

- In Follow, Spotlight, and DirectionTrack modes, DJI Flip will hover in place if the camera loses the subject while recording. Run DJI Fly on your smartphone via Wi-Fi to connect to DJI Flip mid-flight. The smartphone must have been connected to DJI Fly previously in order to connect. In the Controls view, make sure that the task has already stopped, select **Manual Control** from the mode list, and then land DJI Flip using the virtual joysticks.
-

3.2 Mobile App Control



It is recommended to click the link below or scan the QR code to watch the tutorial video.



<https://www.dji.com/flip/video>

To use Mobile App Control, connect DJI Flip to the DJI Fly app on the smartphone via Wi-Fi and control DJI Flip in the app. In Mobile App Control, all the functions for Palm Control are available. You can set parameters and perform Smart Snaps in the app. More functions such as manual control, audio recording, and voice control are also supported.

Notice

- Power off the remote control devices that are connected to the aircraft before using Mobile App Control. If not powered off, the aircraft will disconnect from the other devices automatically when the smartphone is connected via Wi-Fi and the Controls view in the app is opened.
-

- Make sure to fly in an open and unobstructed environment without signal interference. Otherwise, the app may disconnect from DJI Flip which may affect flight safety.

- When using Mobile App Control, the max flight altitude of DJI Flip is 30 m and the max flight distance is 50 m.
- Return to Home (RTH) is not supported in Mobile App Control. Maintain visual line of sight within a controlled area.
- DO NOT fly over water.
- DJI Flip will land automatically in the following situations. Make sure to observe the operating environment to avoid DJI Flip to be lost or damaged when landing.
 - Critical low battery.
 - Positioning fails and DJI Flip enters Attitude mode.
 - DJI Flip detects a collision but does not crash.

Connecting DJI Flip

1. Power on DJI Flip and wait for the system self-diagnostics to complete.
2. Enable Bluetooth, Wi-Fi, and location services on the smartphone.
3. Tap **Connection Guide** on the bottom right corner of the home screen in the app, select the device model, and select **Connect via Mobile Device**.
4. Select the desired device in the search results. The Controls view is displayed after connected successfully. When connecting the smartphone to DJI Flip for the first time, press and hold the power button of DJI Flip to confirm.





- You can also tap the QuickTransfer or Wi-Fi Devices panel on the home screen in DJI Fly for Wi-Fi connection.
 - To change the smartphone connected to DJI Flip, disable Bluetooth and Wi-Fi on the currently connected smartphone before connecting DJI Flip to the new smartphone.
-

3.3 RC Control

Auto Takeoff

1. Launch DJI Fly and enter the camera view.
2. Complete all steps in the pre-flight checklist.
3. Tap . If conditions are safe for takeoff, press and hold the button to confirm.
4. The aircraft will take off and hover above the ground.

Auto Landing

1. If conditions are safe to land, tap , then tap and hold  to confirm.
2. Auto landing can be canceled by tapping .
3. If the Downward Vision System is working normally, Landing Protection will be enabled.
4. Motors will stop automatically after landing.

 • Choose an appropriate place for landing.

Starting/Stopping the Motors

Starting the Motors

Perform one of the Combination Stick Commands (CSC) as shown below to start the motors. Once the motors have started spinning, release both sticks simultaneously.



Stopping the Motors

The motors can be stopped in two ways:

Method 1: When the aircraft has landed, push the throttle stick down and hold until the motors stop.



Method 2: When the aircraft has landed, perform one of the CSC as shown below until the motors stop.



Stopping the Motors Mid-Flight

 • Stopping the motors mid-flight will cause the aircraft to crash.

The default setting for **Emergency Propeller Stop** in the DJI Fly app is **Emergency Only**, which means that the motors can only be stopped mid-flight when the aircraft detects that it is in an emergency situation such as the aircraft is involved in a collision, a motor has stalled, the aircraft is rolling in the air, or the aircraft is out of control and is ascending or descending very quickly. To stop the motors mid-flight, perform the same CSC that was used to start the motors. Note that you need to hold the control sticks for two seconds while performing the CSC to stop the motors. **Emergency Propeller Stop** can be changed to **Anytime** in the app. Use this option with caution.

Controlling the Aircraft

The control sticks of the remote controller can be used to control the aircraft movements. The control sticks can be operated in Mode 1, Mode 2, or Mode 3, as shown below.

The default control mode of the remote controller is Mode 2. In this manual, Mode 2 is used as an example to illustrate how to use the control sticks. The more the stick is pushed away from the center, the faster the aircraft moves.

Mode 1

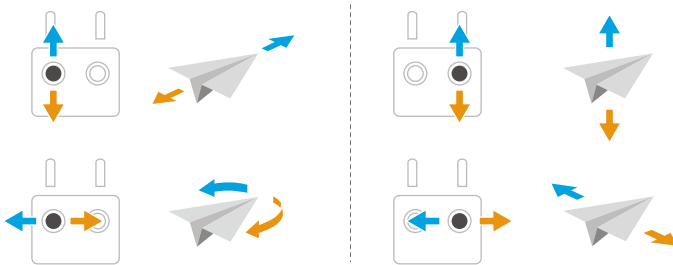

Mode 2

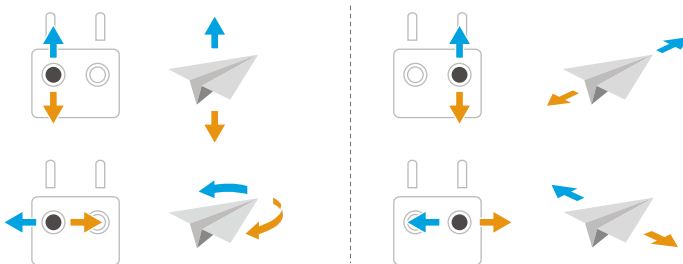

Mode 3

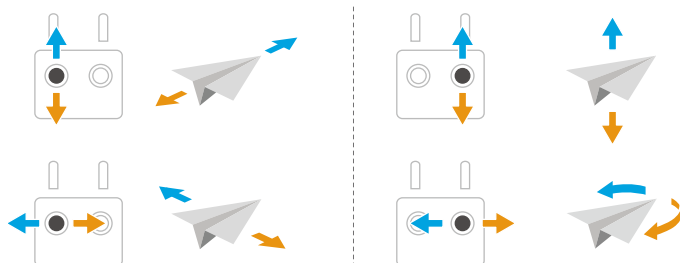

Takeoff/Landing Procedures

- ⚠ • DO NOT operate the aircraft when the lighting is too bright or too dark to use the remote controller to monitor flight. You are responsible for the correct adjustment of display brightness and amount of direct sunlight on the screen, as to avoid difficulty in viewing the screen clearly.
-

1. The pre-flight checklist is designed to help you fly safely. Go through the full pre-flight checklist before each flight.
2. Place the aircraft in an open, flat area with the rear of the aircraft facing towards you.
3. Power on the remote controller and the aircraft.
4. Launch DJI Fly and enter the camera view.
5. Wait for the aircraft self-diagnostics to complete. If DJI Fly does not show any irregular warning, you can start the motors.
6. Push the throttle stick up slowly to take off.
7. To land, hover over a level surface and push the throttle stick down to descend.
8. After landing, push the throttle down and hold until the motors stop.
9. Power off the aircraft before the remote controller.

Intelligent Flight Modes



It is recommended to click the link below or scan the QR code to watch the tutorial video.



<https://www.dji.com/flip/video>

FocusTrack

FocusTrack includes Spotlight, Point of Interest (POI), and ActiveTrack.

- The aircraft does not automatically take photos or record videos while using FocusTrack. Manually control the aircraft to take photos or record videos.

Spotlight: Enables the camera to face the subject at all times, while manually controlling the flight.

POI: Allows the aircraft to fly around the subject based on the set radius and flight speed.



ActiveTrack: The aircraft follows a moving subject at a certain distance and altitude. ActiveTrack can only track people.

- In ActiveTrack, you can use the remote controller to control the aircraft orientation, ascend or descend, or fly forward and backward.

In ActiveTrack, the supported follow ranges of the aircraft and subject are as follows:

Subject	People
Horizontal Distance	2-10 m (Optimal Distance: 2-7 m)
Altitude	0.5-10 m (Optimal Distance: 0.5-5 m)

Notice

-  The aircraft cannot avoid moving subjects such as people, animals, or vehicles. When using FocusTrack, pay attention to the surrounding environment to ensure flight safety.
- DO NOT use FocusTrack in areas with small or fine objects (e.g., tree branches or power lines), transparent objects (e.g., water or glass), or monochrome surfaces (e.g., white walls).
- Always be prepared to press the Flight Pause button on the remote controller or tap  in DJI Fly in order to operate the aircraft manually in case any emergency situation occurs.

- Be extra vigilant when using FocusTrack in any of the following situations:
 - The tracked subject is not moving on a level plane.
 - The tracked subject has large movements or changes pose.
 - The tracked subject is out of sight for an extended period.
 - The tracked subject is moving on a snowy surface.
 - The tracked subject has a similar color or pattern to its surrounding environment.
 - The lighting is extremely dark (<15 lux) or bright (>10,000 lux).
 - Make sure to follow local privacy laws and regulations when using FocusTrack.
 - It is recommended to only track people (but not children). Fly with caution when tracking other subjects.
 - The tracking subject may be inadvertently swapped to another subject if they pass nearby each other.
-

Using FocusTrack

Before enabling FocusTrack, make sure the flying environment is open and unobstructed with sufficient light.

Tap the FocusTrack icon [•] on the left of the camera view, or select the subject on the screen to enable FocusTrack. After enabling, tap the FocusTrack icon [•] again to exit.

MasterShots



The aircraft will select a preset flight route based on the subject type and distance, and automatically take a variety of classic aerial photography shots.

Notice

- ⚠ • Use MasterShots at locations that are clear of buildings and other obstacles. Make sure there are no people, animals, or other obstacles in the flight path.
- Always pay attention to obstacles around the aircraft and use the remote controller to avoid collisions or the aircraft being obstructed.
- DO NOT use MasterShots in any of the following situations:
 - When the subject is blocked for an extended period of time or outside the visual line of sight.
 - When the subject is similar in color or pattern with the surroundings.

- When the subject is in the air.
- When the subject is moving fast.
- The lighting is extremely dark (<15 lux) or bright (>10,000 lux).
- DO NOT use MasterShots in places close to buildings or where the GNSS signal is weak. Otherwise, the flight path may become unstable.
- Make sure to follow local privacy laws and regulations when using MasterShots.

Using MasterShots

1. Tap the Shooting Mode icon on the right side of the camera view and select MasterShots .
2. After drag-selecting the subject and adjusting the shooting area, tap  to begin recording and the aircraft will start flying and recording automatically. The aircraft will fly back to its original position once recording is finished.
3. Tap  or press the Flight Pause button on the remote controller once. The aircraft will exit MasterShots immediately and hover.

QuickShots



QuickShots include multiple shooting modes. The aircraft automatically records according to the selected shooting mode and generates a short video.

Notice

-  • Make sure there is sufficient space when using Boomerang. Allow a radius of at least 30 m (99 ft) around the aircraft and a space of at least 10 m (33 ft) above the aircraft.
- Make sure there is sufficient space when using Asteroid. Allow at least 40 m (131 ft) behind and 50 m (164 ft) above the aircraft.
- Use QuickShots at locations that are clear of buildings and other obstacles. Make sure there are no people, animals, or other obstacles in the flight path.
- Always pay attention to objects around the aircraft and use the remote controller to avoid collisions or the aircraft being obstructed.
- DO NOT use QuickShots in any of the following situations:
 - When the subject is blocked for an extended period of time or outside the visual line of sight.
 - When the subject is similar in color or pattern with the surroundings.

- When the subject is in the air.
 - When the subject is moving fast.
 - The lighting is extremely dark (<15 lux) or bright (>10,000 lux).
 - DO NOT use QuickShots in places close to buildings or where the GNSS signal is weak. Otherwise, the flight path will become unstable.
 - Make sure to follow local privacy laws and regulations when using QuickShots.
-



Using QuickShots

1. Tap the Shooting Mode icon on the right side of the camera view and select QuickShots .
2. After selecting one sub-mode, tap the plus icon or drag-select the subject on the screen. Then tap  to begin shooting. The aircraft will record footage while performing a preset flight movement according to the option selected, and generate a video afterwards. The aircraft will fly back to its original position once recording is finished.
3. Tap  or press the Flight Pause button on the remote controller once. The aircraft will exit QuickShots immediately and hover.

Hyperlapse

Hyperlapse takes a certain number of photos according to the time interval, and then compiles these photos into a video of a few seconds. It is especially suitable for recording scenes with moving elements, such as traffic flow, clouds drifting, and sunrises and sunsets.

Using Hyperlapse

1. Tap the Shooting Modes icon from the camera view and select Hyperlapse .
2. Select the Hyperlapse mode. After setting the related parameters, tap the shutter/record button  to begin the process.
3. Tap  or press the Stop button on the remote controller, the aircraft will exit Hyperlapse and hover.

Cruise Control

Cruise Control enables the aircraft to fly at a constant speed automatically, which makes long distance flights effortless, and helps to avoid image shaking which often happens during manual operation. More camera movements, such as spiraling up, can be achieved by increasing control stick input.

-
- ⚠ • The obstacle sensing in cruise control follows the current flight mode. Fly with caution.
-

Using Cruise Control

1. Set one customizable button of the remote controller to Cruise Control.
2. When pushing the control sticks, press the cruise control button, and the aircraft will automatically fly at the current speed.
3. Press Flight Pause button on the remote controller once, or tap  to exit cruise control.

Recording Audio via App

In the camera view of the app, tap ***** > Camera** to enable app recording and select the noise reduction effect. Audio will be recorded by the corresponding audio recording device while the aircraft is recording a video. The microphone icon will be displayed in liveview.

Supported audio recording devices include the built-in microphone of the smartphone, DJI Mic 2, and Bluetooth earphones. For a list of compatible Bluetooth devices, please refer to the Downloads page on the DJI Flip official webpage. Audio recording compatibility issues may occur when using some Bluetooth earphones. Make sure to test them before recording.

-
- ⚠ • DO NOT turn off the screen or switch to other apps during recording.
-

- 💡 • Audio recording can only be enabled or disabled before recording.
 - When viewing or downloading the videos in the Album view in DJI Fly, the audio recorded using the audio recording function will be automatically merged into the video file.
-

3.4 Video Suggestions and Tips

1. Select the desired gimbal operation mode in DJI Fly.
2. It is recommended to take photos or record videos when flying in Normal or Cine mode.
3. DO NOT fly in bad weather such as on rainy or windy days.
4. Choose the camera settings that best suit your needs.
5. Perform flight tests to establish flight routes and preview scenes.
6. Push the control sticks gently to ensure smooth and stable movement of the aircraft.

Aircraft

4 Aircraft

4.1 Flight Mode

The aircraft supports the following flight modes, which can be switched via the Flight Mode switch on the remote controller.

Normal Mode: Normal mode is suitable for most flight scenarios. The aircraft can hover precisely, fly stably, and use Intelligent Flight Modes.

Sport Mode: The maximum horizontal flight speed of the aircraft will be higher when compared with Normal mode. Note that obstacle sensing is disabled in Sport mode.

Cine Mode: Cine mode is based on Normal mode with a limited flight speed, making the aircraft more stable during recording.

The aircraft automatically changes to Attitude (ATTI) mode when the vision system is unavailable or disabled and the GNSS signal is weak or the compass experiences interference. In ATTI mode, the aircraft may be more easily affected by its surroundings. Environmental factors such as wind can result in horizontal drift of the aircraft, which may present hazards, especially when flying in confined spaces. The aircraft will not be able to hover or brake automatically, therefore the pilot should land the aircraft as soon as possible to avoid accidents.



- The flight modes are only effective for manual flight and cruise control.





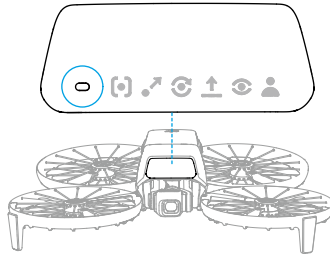

- The vision system is disabled in Sport mode, which means the aircraft cannot sense obstacles on its route automatically. You must stay alert to the surrounding environment and control the aircraft to avoid obstacles.
 - The maximum speed and braking distance of the aircraft significantly increase in Sport mode. A minimum braking distance of 30 m is required in windless conditions.
 - A minimum braking distance of 10 m is required in windless conditions while the aircraft is ascending and descending in Sport mode or Normal mode.
 - The responsiveness of the aircraft significantly increases in Sport mode, which means a small control stick movement on the remote controller translates into the aircraft moving a large distance. Make sure to maintain adequate maneuvering space during flight.
 - You may experience shaking in videos recorded in Sport mode.
-

4.2 Aircraft Status Indicators







Aircraft Status Indicators Descriptions

Normal States

	Blinks red, yellow, and green alternately	Powering on and performing self-diagnostic tests
	Blinks green slowly	GNSS enabled
	Blinks green twice repeatedly	Vision systems enabled
	Blinks yellow slowly	GNSS and vision system disabled (ATTI mode enabled)

Warning States

	Blinks red slowly	Takeoff is disabled (e.g., low battery) ^[1]
	Blinks red quickly	Critically low battery
	Solid red	Critical error
	Blinks red and yellow alternately	Compass calibration required



[1] If the aircraft cannot take off while the status indicators are blinking red slowly, view the warning prompt in DJI Fly.

4.3 Return to Home

Carefully read the contents of this section to ensure you are familiar with the behavior of the aircraft in Return-to-Home (RTH).

The Return to Home (RTH) function will automatically fly the aircraft back to the last recorded Home Point. RTH can be triggered in three ways: the user actively triggers RTH, the aircraft has low battery, or the remote controller signal has been lost (Failsafe RTH is

triggered). If the aircraft has recorded the Home Point successfully and the positioning system is functioning normally, when the RTH function is triggered, the aircraft will automatically fly back and land at the Home Point.

-
-  • **Home Point:** The Home Point will be recorded at takeoff as long as the aircraft has a strong GNSS signal  26 . After the Home Point is recorded, DJI Fly will issue a voice prompt. If it is necessary to update the Home Point during a flight (such as if you have changed your position), the Home Point can be manually updated in *** > **Safety** page in DJI Fly.
-

During RTH, the AR RTH route will be displayed on the camera view, helping you to view the return path and ensure flight safety. The camera view also displays the AR Home Point. When the aircraft reaches the area above the Home Point, the gimbal camera will automatically flip downwards. The AR aircraft shadow will appear in the camera view when the aircraft is approaching the ground, enabling you to control the aircraft to land more accurately in your preferred location.

The AR Home Point, AR RTH route, and AR aircraft shadow will be displayed in the camera view by default. The display can be changed in *** > **Safety** > **AR Settings**.

-
-  • The AR RTH route is only used for reference, and may deviate from the actual flight route in different scenarios. Always pay attention to the liveview on the screen during RTH. Fly with caution.
 - During RTH, the aircraft will automatically adjust the gimbal tilt to point the camera toward the RTH route by default. Using the gimbal dial to adjust the camera orientation or pressing the customizable buttons on the remote controller to recenter the camera will stop the aircraft from automatically adjusting the gimbal tilt, which may prevent the AR RTH route from being viewed.
-

Notice

-
-  • The aircraft may not be able to return to the Home Point as normal if the positioning system is functioning abnormally. During Failsafe RTH, the aircraft may enter ATTI mode and land automatically if the positioning system is functioning abnormally.
 - When there is no GNSS, do not fly over water surfaces, buildings with glass surface, or in scenarios where the altitude above the ground is greater than 30 meters. If the positioning system is functioning abnormally, the aircraft will enter ATTI mode.

- It is important to set a suitable RTH altitude before each flight. Launch DJI Fly and set the RTH altitude.
 - The aircraft cannot sense obstacles during RTH if the environment conditions are not suitable for the sensing system.
 - GEO zones may affect the RTH. Avoid flying near GEO zones.
 - The aircraft may not be able to return to a Home Point if the wind speed is too high. Fly with caution.
 - Pay extra attention to small or fine objects (such as tree branches or power lines) or transparent objects (such as water or glass) during RTH. Exit RTH and control the aircraft manually in an emergency.
 - If the max altitude is adjusted below the current altitude during RTH, the aircraft will descend to the max altitude first and then continue returning to home.
 - The RTH Altitude cannot be changed during RTH.
 - If there is a large difference between the current altitude and the RTH altitude, the amount of battery power used cannot be calculated accurately due to wind speed differences at different altitudes. Pay extra attention to the battery power prompts and warning prompts in DJI Fly.
 - When the remote controller signal is normal during RTH, the pitch stick can be used to control the flight speed, but the orientation and altitude cannot be controlled and the aircraft cannot be controlled to fly to the left or right. Constantly pushing the pitch stick to accelerate will increase the battery power consumption speed. The aircraft will brake and hover in place and exit RTH if the pitch stick is pushed all the way down. The aircraft can be controlled after the pitch stick is released.
 - If the Home Point is within the Altitude Zone but the aircraft is not in the Altitude Zone, when the aircraft reaches the Altitude Zone it will descend below the altitude limit, which may be lower than the set RTH altitude. Fly with caution.
 - The aircraft will exit RTH if the surrounding environment is too complex to complete RTH, even if the sensing system is working properly.
 - RTH cannot be triggered during auto landing.
-

Trigger Method

The user actively triggers RTH

During flight, you can trigger RTH by pressing and holding the RTH button on the remote controller, or tapping  from the left side of the camera view and then pressing and holding the RTH icon.

Aircraft low battery

During flight, if the battery level is low and only sufficient to fly to the Home Point, a warning prompt will appear in DJI Fly. If you tap to confirm RTH or do not take action before the countdown ends, the aircraft will automatically initiate low battery RTH.

If you cancel the low battery RTH prompt and continue flying the aircraft, the aircraft will land automatically when the current battery level can only support the aircraft long enough to descend from its current altitude.

Auto landing cannot be cancelled but you can still fly the aircraft horizontally by moving the pitch stick and roll stick, and change the descent speed of the aircraft by moving the throttle stick. Fly the aircraft to a suitable place for landing as soon as possible.



- When the Intelligent Flight Battery level is too low and there is not enough power to return home, land the aircraft as soon as possible. Otherwise, the aircraft will crash after the battery power is completely depleted.
 - DO NOT keep pushing the throttle stick upward during auto landing. Otherwise, the aircraft will crash after the battery power is completely depleted.
-

Loss of remote controller signal

When the remote controller signal is lost, the aircraft will automatically initiate Failsafe RTH if the Signal Lost Action is set to RTH.

The aircraft will fly backwards 50 m along its original flight route and then perform the RTH procedure. The aircraft will directly perform the RTH procedure if the signal is restored when flying backward along the original flight route.

RTH Procedure

After RTH is triggered, the aircraft brakes and hovers in place.

- If the RTH distance is farther than 50 m, it ascends to the RTH altitude and flies back to the Home Point. The aircraft flies to the Home Point at the current altitude if the current altitude is higher than the RTH altitude. ^[1]
- If the RTH distance is farther than 5 m but less than 50 m, the aircraft adjusts its orientation and flies straight at the current altitude back to the Home Point. ^[2]
- The aircraft lands immediately if the RTH distance is less than 5 m.

[1] If the forward 3D infrared sensing system detects an obstacle ahead, the aircraft will ascend to avoid the obstacle. It will stop climbing once the path ahead is clear and then continue to RTH. If the obstacle height exceeds the altitude limit, the aircraft will brake and hover, and you will need to take control. If the distance to the obstacle ahead is less than 3 meters, the aircraft will fly backward to a safe distance and then ascend to avoid the obstacle. The aircraft cannot sense obstacles when flying backward.

- [2] If the forward 3D infrared sensing system detects an obstacle ahead, the aircraft will brake and hover, and you will need to take control.

4.4 Auto Landing

In some situations, DJI Flip will land automatically with the landing protection function supported.

-
-  • DO NOT prevent DJI Flip from landing continuously due to a critical low battery. Otherwise, the battery will be damaged or DJI Flip will crash.
-

Trigger Method

In the following situations, DJI Flip will land automatically:

- DJI Flip reaches above the Home Point after RTH is triggered.
- DJI Flip has a critical low battery level.
- In Palm Control and Mobile App Control, positioning fails or DJI Flip detects a collision but does not crash.

Landing Protection

Landing Protection activates during auto landing

The specific actions of DJI Flip are as follows:

- If the ground is determined suitable for landing, DJI Flip will land directly.
- If the ground is determined unsuitable for landing, DJI Flip will hover and wait for pilot confirmation. You can perform palm landing or land DJI Flip manually.
- If DJI Flip fails to determine whether the ground environment is suitable for landing, DJI Fly will display a landing prompt when DJI Flip descends to a certain distance from the ground. Confirm the landing prompt and DJI Flip will land. You can also perform palm landing or land DJI Flip manually.

-
-  • Landing Protection only assists in determining the landing environment. Pay attention to the surrounding environment during landing to ensure safety.
- In the following situations, Landing Protection may be unavailable and DJI Flip may land directly on unsuitable ground:
 - Flying over monochrome, reflective, or low-light surfaces, a large area of surfaces without clear texture, or surfaces with dynamic texture, such as

smooth ceramic tiles, garage floors with insufficient light, and grass blowing in the wind.

- Flying over obstacles without clear texture, such as large rocks, or reflective or monochrome surfaces, such as raised tiles.
 - Flying over small or fine obstacles, such as power lines and tree branches.
 - Flying over surfaces that resemble flat ground, such as trimmed and flat shrubs, flat tree tops, and hemispherical ground.
 - In the following situations, Landing Protection may be triggered by mistake and DJI Flip is unable to land. You can perform palm landing or land DJI Flip manually.
 - Flying over surfaces that the vision system may confuse for water, such as wet ground and areas with puddles.
 - Flying over flat surfaces, but there are surfaces with clear texture (oblique surfaces or stairs) nearby.
-

4.5 Sensing System

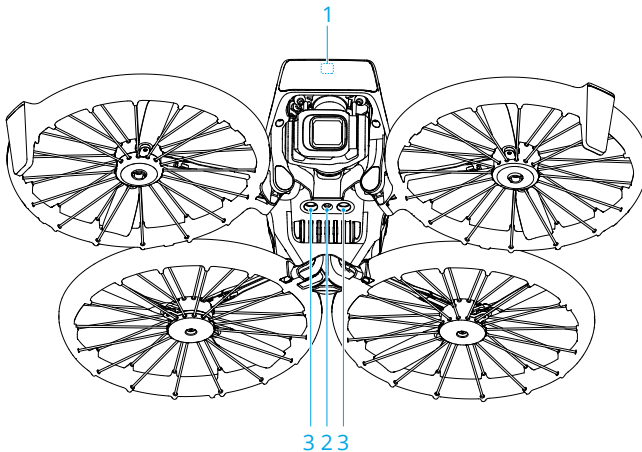

1. Forward 3D Infrared Sensing System*
2. Downward Vision System
3. Downward Infrared Sensing System

* The 3D infrared sensing system meets the human eye safety requirements for Class 1 laser products.

The forward 3D infrared sensing system can sense the obstacles in the front. It will activate automatically when the aircraft is in Normal or Cine mode and **Obstacle Avoidance Action** is set to **Brake** in DJI Fly. The positioning function of the downward vision system is applicable when GNSS signals are unavailable or weak.

Obstacle sensing is only available when manually controlling the aircraft to fly forward or during auto RTH. There is no obstacle sensing when using Intelligent Flight Modes or Smart Snaps.



Notice

- ⚠ • Pay attention to the flight environment. The sensing system only works in certain scenarios and cannot replace human control and judgment. During a flight, always pay attention to the surrounding environment and the warnings in DJI Fly, and be responsible for and maintain control of the aircraft at all times.
- If there is no GNSS available, the downward vision system will assist with aircraft positioning, and works best when the aircraft is at an altitude from 0.5 m to 10 m. Extra caution is required if the altitude of the aircraft is above 10 m as the vision positioning performance may be affected.
- The downward vision system may not work properly when the aircraft is flying near water. Therefore, the aircraft may not be able to actively avoid water below it when landing. It is recommended to maintain flight control at all times, make reasonable judgments based on the surrounding environment, and avoid over-relying on the downward vision system.
- The vision system cannot accurately identify large structures with frames and cables, such as tower cranes, high-voltage transmission towers, high-voltage transmission lines, cable-stayed bridges, and suspension bridges.
- The vision system cannot work properly near surfaces without clear pattern variations or where the lighting is too weak or too strong. The vision system cannot work properly in the following situations:
 - Flying near monochrome surfaces (e.g., pure black, white, red, or green).
 - Flying near highly reflective surfaces.
 - Flying near water or transparent surfaces.
 - Flying near moving surfaces or objects.
 - Flying in an area with frequent and drastic lighting changes.
 - Flying near extremely dark (<15 lux) or bright (>10,000 lux) surfaces.
 - Flying near surfaces that strongly reflect or absorb infrared waves (e.g., mirrors).

- Flying near surfaces without clear patterns or textures.
 - Flying near surfaces with repeating identical patterns or textures (e.g., tiles with the same design).
 - Flying near obstacles with small surface areas (e.g., tree branches, and power lines).
 - Keep the sensors clean at all times. DO NOT scratch or tamper with the sensors. DO NOT use the aircraft in dusty or humid environments.
 - The vision system cameras may need to be calibrated after being stored for an extended period. A prompt will appear in DJI Fly and calibration will be performed automatically.
 - DO NOT fly when it is rainy, smoggy, or the visibility is lower than 100 m.
 - DO NOT obstruct the sensing system.
 - Check the following each time before takeoff:
 - Make sure there are no stickers or any other obstructions over the glass of the sensing system.
 - Use a soft cloth if there is any dirt, dust, or water on the glass of the sensing system. DO NOT use any cleaning product that contains alcohol.
 - Contact DJI Support if there is any damage to the lenses of the sensing system.
 - When the aircraft accelerates forward, it will tilt forward. If the aircraft is manually controlled to fly close to the ground, the forward 3D infrared sensing system may detect obstacles near the ground ahead, causing the aircraft to automatically decelerate and hover. The aircraft automatically returns to a level attitude when hovering, and thus the obstacles close to the ground are no longer detected, allowing the aircraft to continue responding to forward control stick input. The above phenomenon is normal behavior for the aircraft.
 - The performance of the aircraft's infrared sensing system may be affected if there is interference from infrared light sources in the environment.
-

4.6 Propellers

There are two types of propellers, which are designed to spin in different directions. Marks are used to indicate which propellers should be attached to which motors. Make sure to match the propellers and motors by following the instructions.

Propellers	Marked	Unmarked
Illustration		
Mounting Position	Attach to the motors of the marked arm	Attach to the motors of the unmarked arm

Notice

- ⚠ • Make sure to only use the screwdriver from the aircraft package for mounting propellers. Using other screwdrivers may damage the screws.
- Make sure to keep the screws vertical while tightening them. The screws should not be at a tilted angle to the mounting surface. After installation is complete, check whether the screws are flush and rotate the propellers to check for any abnormal resistance.
- The propeller blades are sharp. Handle with care to avoid personal injury or propeller deformation.
- Make sure that the propellers and motors are installed securely before each flight. Check to make sure the screws on the propellers are tightened after every 30 hours of flying time (approx. 60 flights).
- The screwdriver is only for mounting the propellers. DO NOT use the screwdriver to disassemble the aircraft.
- If a propeller is broken, remove the two propellers and screws on the corresponding motor and discard them. Use two propellers from the same package. DO NOT mix with propellers from other packages.
- Only use official DJI propellers. DO NOT mix propeller types.
- Propellers are consumable components. Purchase additional propellers if necessary.
- Make sure that all propellers are in good condition before each flight. DO NOT use aged, chipped, or broken propellers. Clean the propellers with a soft, dry cloth if there is any foreign matter attached.
- To avoid injury, stay away from rotating propellers or motors.
- To avoid damaging the propellers, place the aircraft correctly during transportation or storage. DO NOT squeeze or bend the propellers. If propellers are damaged, the flight performance may be affected.
- Make sure the motors are mounted securely and rotating smoothly. Land the aircraft immediately if a motor is stuck and unable to rotate freely.
- DO NOT attempt to modify the structure of the motors.

- DO NOT touch or let hands or body parts come in contact with the motors after flight, as they may be hot.
 - DO NOT block any of the ventilation holes on the motors or the body of the aircraft.
 - Make sure the ESCs sound normal when powered on.
-

Replacing the Propellers



It is recommended to click the link below or scan the QR code to watch the tutorial video.



<https://www.dji.com/flip/video>

Make sure DJI Flip is powered off.

1. Remove the old propellers and screws using the screwdriver from the aircraft package.

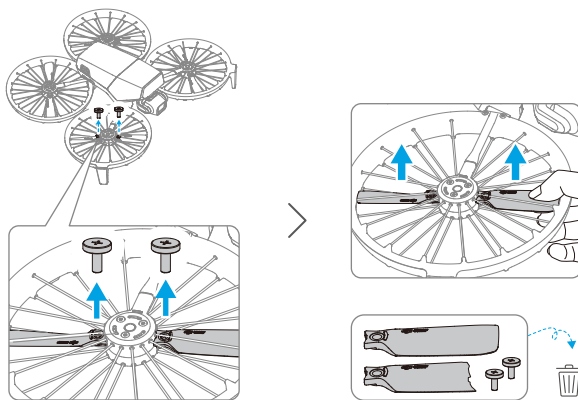

2. The packaging of the propellers are labelled A and B with their corresponding installation positions. There is a raised mark on Propeller A while Propeller B does not have any mark. Refer to the diagram for the corresponding propellers and the motors.

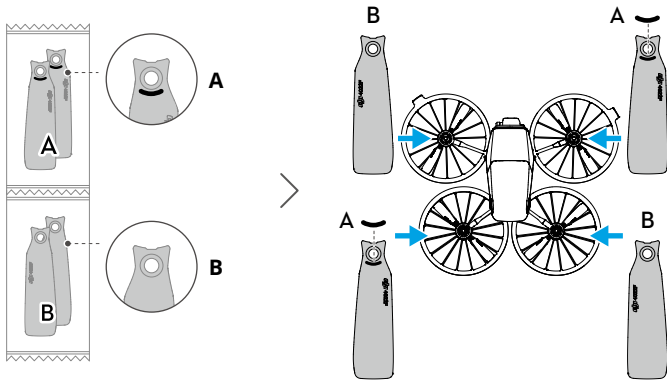

3. When installing, hold the end of the propeller with one hand, ensuring the DJI logo is facing up. Gently lift the propeller guard and insert the propeller through the gap from below. Meanwhile, use the screwdriver with the other hand to assist in aligning the screw hole of the propeller with the protrusion on the motor. After aligning the hole, press down on the propeller a few times with the screwdriver to ensure it is properly seated. Place the screw on the screwdriver, and then tighten the screw. After installation, gently lift the propellers upwards to ensure they are securely fastened!

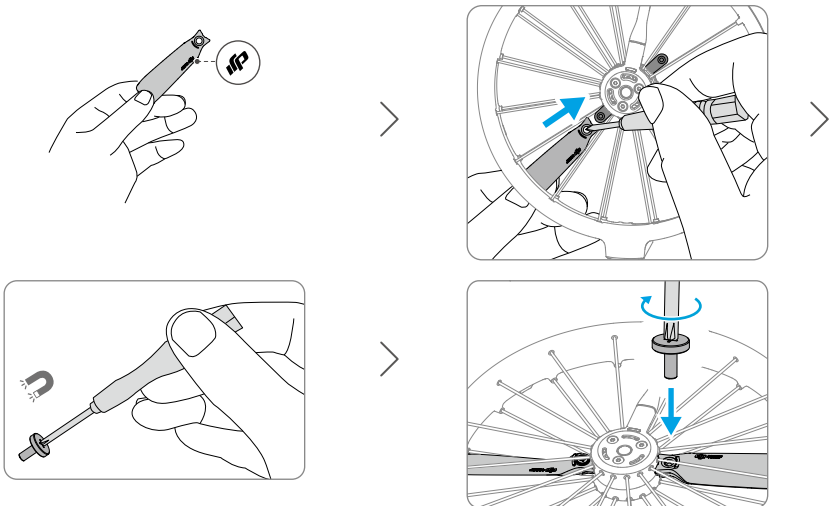

4.7 Intelligent Flight Battery

Notice

-  • Read and strictly follow the instructions in this manual, in the *Safety Guidelines* and on the battery stickers before using the battery. You shall take full responsibility for all operations and usage.
-
1. DO NOT charge an Intelligent Flight Battery immediately after flight as it may be too hot. Wait for the battery to cool down to the allowable charging temperature before charging again.
 2. To prevent damage, the battery only charges when the battery temperature is between 5° and 40° C (41° and 104° F). The ideal charging temperature is from 22° to 28° C (71.6° to 82.4° F). Charging at the ideal temperature range can prolong battery life. Charging stops automatically if the temperature of the battery cells exceeds 55° C (131° F) during charging.
 3. Low-Temperature Notice:
 - Batteries cannot be used in extremely low-temperature environments of lower than -10° C (14° F).
 - Battery capacity is significantly reduced when flying at low temperatures from -10° to 5° C (14° to 41° F). Make sure to fully charge the battery before takeoff. Hover the aircraft in place for a while to warm up the battery after takeoff.
 - It is recommended to warm up the battery to at least 10° C (50° F) before takeoff when flying in low-temperature environments. The ideal temperature to warm up the battery is above 20° C (68° F).
 - The reduced battery capacity in low-temperature environments reduces the wind speed resistance performance of the aircraft. Fly with caution.
 - Take extra caution when flying at a high elevation with a low temperature.
 4. A fully charged battery will automatically discharge when it is idle for a period of time. Note that it is normal for the battery to emit heat during the discharging process.
 5. Fully charge the battery at least once every three months to maintain battery health. If the battery is not used for an extended period, battery performance may be affected or may even cause permanent battery damage. If a battery has not been charged or discharged for three months or more, the battery will no longer be covered by the warranty.
 6. For safety purposes, keep the batteries at a low power level in transit. Before transportation, it is recommended to discharge the batteries to 30% or lower.

Installing/Removing the Battery

Installation

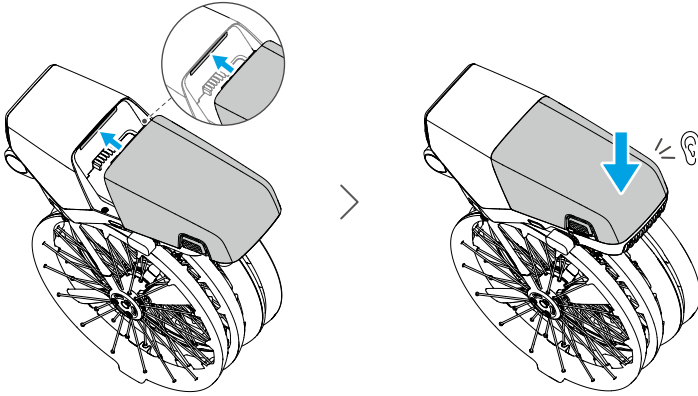

Removal

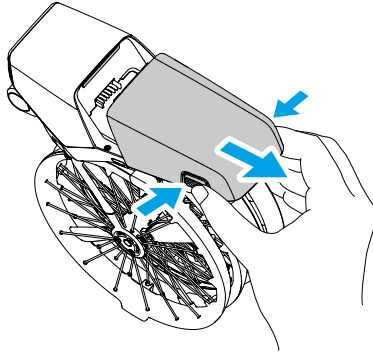

-
-  • DO NOT insert or remove the battery while the aircraft is powered on.
- Make sure the battery is mounted securely with a clicking sound. DO NOT launch the aircraft when the battery is not securely mounted, as this may cause poor contact between the battery and the aircraft and present hazards.
-

Using the Battery

Checking the Battery Level

Press the power button once to check the current battery level.

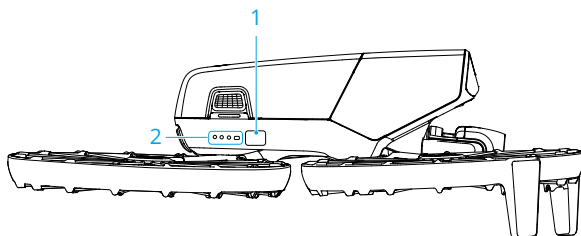

1. Power Button

2. Battery Level LEDs

The battery level LEDs display the power level of the battery during charging and discharging. The statuses of the LEDs are defined below:

- LED is on
- ◉ LED is flashing
- LED is off

Blinking Pattern	Battery Level
◉ ◉ ◉ ◉	88-100%
◉ ◉ ◉ ◉ ◉	76-87%
◉ ◉ ◉ ○	63-75%
◉ ◉ ◉ ◉ ○	51-62%
◉ ◉ ○ ○	38-50%
◉ ◉ ◉ ○ ○	26-37%
◉ ○ ○ ○	13-25%
◉ ◉ ○ ○ ○	0-12%

If the two LEDs shown in below picture blink simultaneously, it indicates the battery is malfunctioning. Remove the battery from the aircraft, insert the battery again and make sure that it is securely mounted.

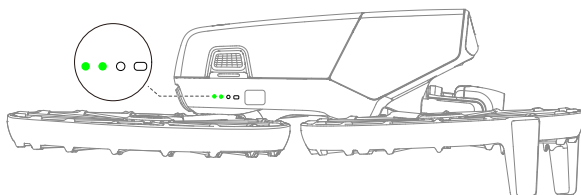

Charging the Battery



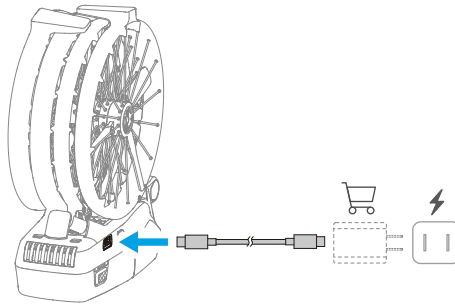

Fully charge the battery before each use. It is recommended to use the charging devices provided by DJI or other chargers that support the USB PD fast charging protocol.

Using a Charger



-
-  • The battery cannot be charged if the aircraft is powered on.
-

The table below shows the battery level during charging.

Blinking Pattern	Battery Level
	0-50%
	51-75%
	76-99%
	100%

-
-  • The blinking frequency of the battery level LEDs differs depending on the USB charger used. If the charging speed is fast, the battery level LEDs will blink quickly.
- Four LEDs blinking simultaneously indicates the battery is damaged.
-

Using the Charging Hub



It is recommended to click the link below or scan the QR code to watch the tutorial video.



<https://www.dji.com/flip/video>

-
- ⚠ • The environmental temperature affects the charging speed. Charging is faster in a well-ventilated environment at 25° C (77° F).
 - The charging hub is only compatible with specific model of the Intelligent Flight Battery. DO NOT use the charging hub with other battery models.
 - Place the charging hub on a flat and stable surface when in use. Make sure the device is properly insulated to prevent fire hazards.
 - DO NOT touch the metal terminals on the battery ports.
 - Clean the metal terminals with a clean, dry cloth if there is any noticeable buildup.
-

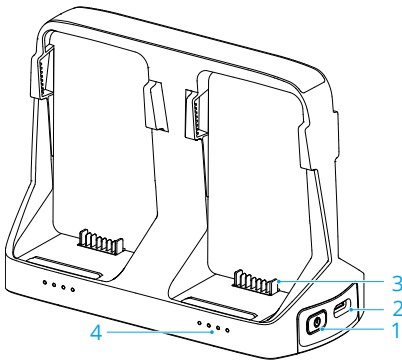

1. Function Button
2. USB-C Connector
3. Battery Port
4. Status LEDs

How to Charge

Installation

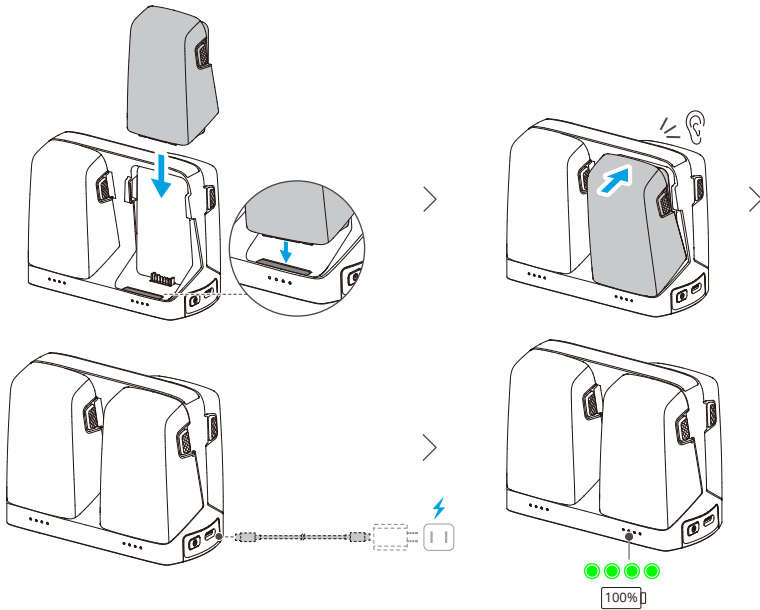

When using chargers with different power ratings to charge multiple batteries, the charging sequence will vary. Refer to the table below for details.

Charger Power <65 W	Charges in sequence from highest to lowest battery level.
Charger Power ≥65 W	Charges two batteries simultaneously: First charges the battery with the second highest battery level until it matches the battery level with the highest charge, then fully charges both batteries together.

Removal

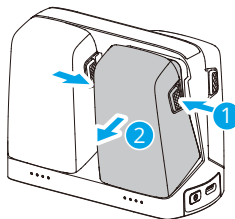

Using Charging Hub as a Power Bank

1. Insert one or more batteries into the charging hub. Connect an external device, such as a smartphone or remote controller to the USB-C port of the charging hub, and then press and hold the function button for three seconds.
2. Batteries will be discharged based on the battery level, from the lowest to the highest, and supply power to the external device. To stop charging the external device, disconnect the external device from the charging hub.

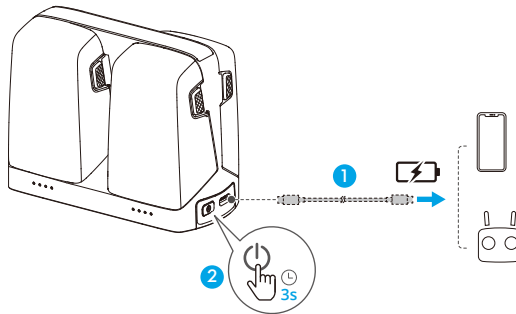

-
-  • If the remaining charge of a battery is lower than 7%, the battery cannot charge the external device.
-

Accumulating Power

1. Insert the Intelligent Flight Batteries into the charging hub, press and hold the function button to transfer the power from the batteries with a lower power level to the battery with the highest power level. The status LEDs for the batteries with a lower power level will display the current power level, while the status LEDs for the battery with a high power level will blink in sequence.
2. To stop accumulating power, press and hold the function button again. After stopping power accumulation, press the function button to check the power level of the batteries.

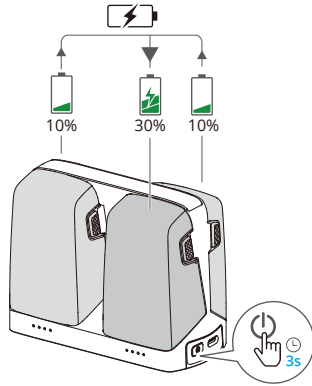

- ⚠** • Power accumulation stops automatically in the following situations:
- The receiving battery is fully charged, or the power of the output battery is lower than 10%.
 - A charger or external device is connected to the charging hub or any battery is inserted or withdrawn from the charging hub during power accumulation.
 - Power accumulation is interrupted for more than 15 minutes due to abnormal battery temperature.
 - After accumulating power, charge the battery with the lowest power level as soon as possible to avoid discharge.

Status LEDs Descriptions

Each battery port of the charging hub has its corresponding status LED array, which can indicate charging status, battery level and abnormal status. The LED status for battery level and battery abnormality is the same as that on the aircraft.

Charging Status

Blinking Pattern	Descriptions
Status LEDs in an array blink quickly successively	The battery in the corresponding battery port is being charged using a USB PD charger.
Status LEDs in an array blink slowly successively	The battery in the corresponding battery port is being charged using a normal charger.
Status LEDs in an array are solid	The battery in the corresponding battery port is fully charged.
All status LEDs blink in sequence	No battery is inserted.

Battery Protection Mechanisms

The battery level LEDs can display battery protection notifications triggered by abnormal charging conditions.

LEDs	Blinking Pattern	Status
	LED2 blinks twice per second	Overcurrent detected
	LED2 blinks three times per second	Short circuit detected
	LED3 blinks twice per second	Overcharge detected
	LED3 blinks three times per second	Over-voltage charger detected
	LED4 blinks twice per second	Charging temperature is too low
	LED4 blinks three times per second	Charging temperature is too high

If any of the battery protection mechanisms are activated, unplug the charger, and plug it in again to resume charging. If the charging temperature is abnormal, wait for it to return to normal. The battery will automatically resume charging without the need to unplug and plug in the charger again.

4.8 Gimbal and Camera

Gimbal Notice

- Make sure there are no stickers or objects on the gimbal before taking off. DO NOT tap or knock the gimbal after the aircraft is powered on. Launch the aircraft from open and flat ground to protect the gimbal.
- Remove the gimbal protector before powering on the aircraft. Attach the gimbal protector when the aircraft is not in use.
- Precision elements in the gimbal may be damaged by a collision or impact, which may cause the gimbal to function abnormally.
- Avoid getting dust or sand on the gimbal, especially in the gimbal motors.
- A gimbal motor may enter protection mode if the gimbal is obstructed by other objects when the aircraft is put on uneven ground or on grass, or if the gimbal experiences an excessive external force, such as during a collision. Wait for the gimbal to return to normal or restart the device.
- DO NOT apply external force to the gimbal after the aircraft is powered on.
- DO NOT add any extra payload other than an official accessory to the gimbal, as this may cause the gimbal to function abnormally or even lead to permanent motor damage.

- Flying in heavy fog or clouds may make the gimbal wet, leading to temporary failure. The gimbal will recover full functionality once it is dry.
- If there are strong winds, the gimbal may vibrate while recording.
- If the gimbal tilt angle is large during flight, and the aircraft tilts forward due to acceleration or deceleration, the gimbal will enter limit protection mode and automatically adjust the angle downward.
- After powering on, if the aircraft is not placed flat for an extended period or if the it is significantly shaken, the gimbal may stop working and enter protection mode. In this case, place the aircraft flat and wait for it to recover.
- If encountering strong winds during flight with the gimbal facing downwards, the body of the aircraft may appear at the edge of the liveview.

Gimbal Operation Modes

Two gimbal operation modes are available. Switch between the different operation modes in *** > **Control**.

Follow Mode: The angle of the gimbal remains stable relative to the horizontal plane. This mode is suitable for capturing stable images.

FPV Mode: When the aircraft is flying forward, the gimbal rolls in sync with the rolling aircraft to provide a first-person flying experience.

Gimbal Angle

Use the gimbal dial on the remote controller to control the tilt of the gimbal. Alternatively, do so through the camera view in DJI Fly. Press and hold the screen until the gimbal adjustment bar appears. Drag the bar to control the gimbal's angle.

Camera Notice



- DO NOT expose the camera lens to an environment with laser beams, such as a laser show, or point the camera at intense light sources for an extended period of time, such as the sun on a clear day, in order to avoid damaging the sensor.
- Make sure the temperature and humidity are suitable for the camera during use and storage.
- Use a lens cleanser to clean the lens to avoid damage or poor image quality.
- DO NOT block any ventilation holes on the camera, as the heat generated may damage the device or cause injury.

- The cameras may not focus correctly in the following situations:
 - Capturing photos and videos of dark objects far away.
 - Capturing photos and videos of objects with repeating identical patterns and textures or objects without clear patterns or textures.
 - Capturing photos and videos of shiny or reflective objects (such as street lighting and glass).
 - Capturing photos and videos of flashing objects.
 - Capturing photos and videos of fast-moving objects.
 - When the aircraft/gimbal is moving fast.
 - Capturing photos and videos of objects with varying distances in the focus range.
 - Capturing photos and videos of nearby objects that are not in the center of the frame.
-

4.9 Storing and Exporting Photos and Videos

Storing

The aircraft supports the use of a microSD card to store your photos and videos. Refer to the Specifications for more information about recommended microSD cards.

Photos and videos can also be saved in the internal storage of the aircraft when no microSD card is available.

Exporting

- Use QuickTransfer to export the footage to a mobile device.
- Connect the aircraft to a computer using a data cable, export the footage in the internal storage of the aircraft or in the microSD card mounted on the aircraft. The aircraft does not need to be powered on during the exporting process.
- Remove the microSD card from the aircraft and insert it into a card reader, and export the footage in the microSD card through the card reader.



- Ensure that the SD card slot and the microSD card are clean and free of foreign objects during use.
- DO NOT remove the microSD card from the aircraft when taking photos or videos. Otherwise, the microSD card may be damaged.

- Check camera settings before use to ensure they are configured correctly.
- Before capturing important photos or videos, take a few images to test whether the camera is operating correctly.
- Make sure to power off the aircraft correctly. Otherwise, the camera parameters will not be saved, and any recorded images or videos may be affected. DJI is not responsible for any loss caused by an image or video recorded in a way that is not machine-readable.

4.10 QuickTransfer

DJI Flip can connect directly to a smartphone via Wi-Fi, enabling you to download photos and videos from DJI Flip to the smartphone.

In Mobile App Control, after the smartphone is connected to DJI Flip, enter QuickTransfer mode by going to the Album view.

When DJI Flip is not connected to the smartphone, you can tap the QuickTransfer or Wi-Fi Devices card on the home screen in DJI Fly to enter QuickTransfer mode. You can also go to Album in DJI Fly on your smartphone, and tap  in the upper right corner to enter QuickTransfer mode.

When connecting the smartphone to DJI Flip for the first time, press and hold the power button of DJI Flip to confirm.



- The maximum download rate can only be achieved in countries and regions where the 5.8 GHz frequency is permitted by laws and regulations, when using devices that support 5.8 GHz frequency band and Wi-Fi connection, and in an environment without interference or obstruction. If 5.8 GHz is not allowed by local regulations (such as in Japan), or your mobile device does not support the 5.8 GHz frequency band, or the environment has severe interference, then QuickTransfer will use the 2.4 GHz frequency band and its maximum download rate will reduce to 6 MB/s.
- When using QuickTransfer, it is not necessary to enter the Wi-Fi password on the settings page of the mobile device in order to connect. Launch DJI Fly and a prompt will appear to connect the device.
- Use QuickTransfer in an unobstructed environment with no interference and stay away from sources of interference such as wireless routers, Bluetooth speakers, or headphones.

Remote Controller

5 Remote Controller

5.1 DJI RC 2

Operations

Powering On/Off

Press the power button once to check the current battery level.

Press, then press and hold to power the remote controller on or off.

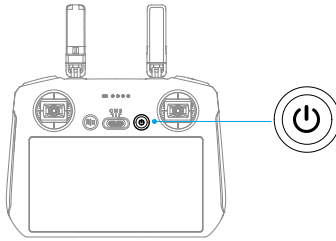

Charging the Battery

Connect the charger to the USB-C port on the remote controller.

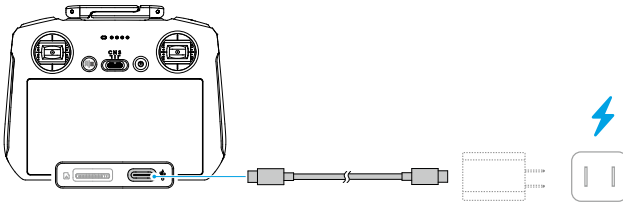

- ⚠️ Fully charge the remote controller before each flight. The remote controller sounds an alert when the battery level is low.
- Fully charge the battery at least once every three months to maintain the battery's health.

Controlling the Gimbal and Camera

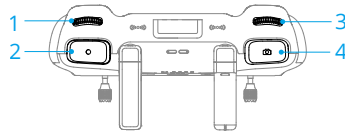

1. **Gimbal Dial:** Control the tilt of the gimbal.
2. **Record Button:** Press once to start or stop recording.
3. **Camera Control Dial:** Use to adjust the zoom by default. The dial function can be set to adjust the focal length, EV, shutter speed, and ISO.
4. **Focus/Shutter Button:** Press halfway down to auto-focus and press all the way down to take a photo.

Flight Mode Switch

Toggle the switch to select the desired flight mode.

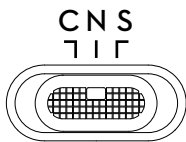

Position	Flight Mode
S	Sport Mode
N	Normal Mode
C	Cine Mode

Flight Pause/RTH Button

Press once to make the aircraft brake and hover in place.

Press and hold the button until the remote controller beeps and starts RTH. The aircraft will return to the last recorded Home Point. Press the button again to cancel RTH and regain control of the aircraft.

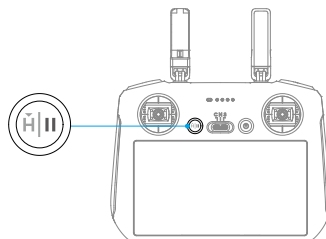

Customizable Buttons

To view and set the button function, go to camera view in DJI Fly, and tap *** > **Control** > **Button Customization**.

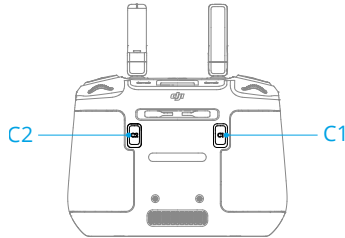



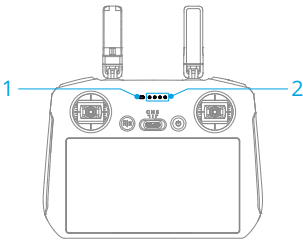





Remote Controller LEDs



1. Status LED
2. Battery Level LEDs

Status LED

Blinking Pattern	Descriptions
 — Solid red	Disconnected from the aircraft.
 Blinking red	The battery level of the aircraft is low.
 Solid green	Connected with the aircraft.
 Blinking blue	The remote controller is linking to an aircraft.
 — Solid yellow	Firmware update failed.
 — Solid blue	Firmware update successful.
 Blinking yellow	The battery level of the remote controller is low.
 Blinking cyan	Control sticks not centered.

Battery Level LEDs

Blinking Pattern	Battery Level
	76-100%
	51-75%
	26-50%
	0-25%

Remote Controller Alert

The remote controller beeps to indicate an error or warning. Pay attention when prompts appear on the touchscreen or in DJI Fly.

Slide down from the top of the screen and select Mute to disable all alerts, or slide the volume bar to 0 to disable some alerts.

The remote controller sounds an alert during RTH, which cannot be cancelled. The remote controller sounds an alert when the battery level of the remote controller is low. A low battery level alert can be cancelled by pressing the power button. When the battery level is critically low, the alert cannot be cancelled.

There will be an alert if the remote controller is not used for a period of time while it is powered on but is not connected to the aircraft. It will automatically power off after the alert stops. Move the control sticks or press any button to cancel the alert.

Optimal Transmission Zone

The signal between the aircraft and the remote controller is most reliable when the antennas are positioned in relation to the aircraft as illustrated below. If the signal is weak, adjust the remote controller orientation, or fly the aircraft closer to the remote controller.

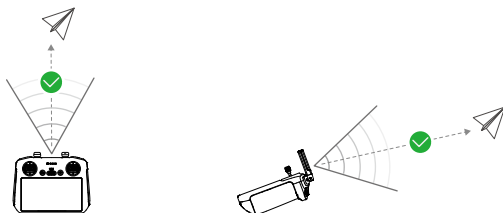

- DO NOT use other wireless devices operating at the same frequency as the remote controller. Otherwise, the remote controller will experience interference.

- A prompt will be displayed in DJI Fly if the transmission signal is weak during flight. Adjust the remote controller orientation according to the attitude indicator display to make sure that the aircraft is in the optimal transmission range.

Linking the Remote Controller

The remote controller is already linked to the aircraft when purchased together as a combo. Otherwise, follow the steps below to link the remote controller and the aircraft after activation.

1. Power on the aircraft and the remote controller.
2. Launch DJI Fly.
3. In camera view, tap *** > **Control** > **Re-pair to Aircraft**. During linking, the status LED of the remote controller blinks blue and the remote controller beeps.
4. Press and hold the power button of the aircraft for more than four seconds. The aircraft beeps, and its battery level LEDs blink in sequence to indicate it is ready to link. The remote controller will beep twice, and its status LED will turn solid green to indicate linking is successful.



- Make sure the remote controller is within 0.5 m of the aircraft during linking.
- The remote controller will automatically unlink from an aircraft if a new remote controller is linked to the same aircraft.

Operating the Touchscreen



- Note that the touchscreen is not waterproof. Operate with caution.

Screen Gestures

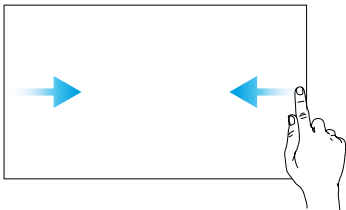

Back: Slide from the left or right to the center of the screen to return to the previous screen.

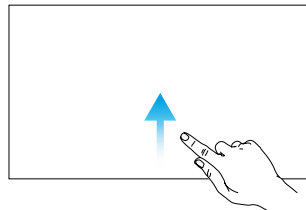

Return to DJI Fly: Slide up from the bottom of the screen to return to DJI Fly.

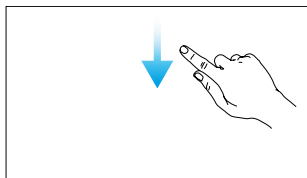

Open the status bar: Slide down from the top of the screen to open the status bar when in DJI Fly.

The status bar displays the time, Wi-Fi signal, battery level of the remote controller, etc.

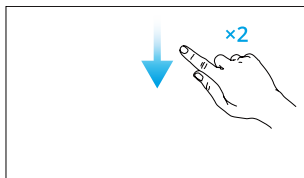

Open Quick Settings: Slide down twice from the top of the screen to open Quick Settings when in DJI Fly.

5.2 DJI RC-N3

Operations

Powering On/Off

Press the power button once to check the current battery level.

Press, then press and hold to power the remote controller on or off.

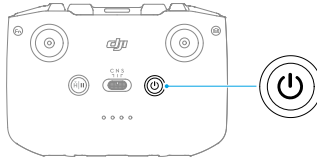

Charging the Battery

Connect the charger to the USB-C port on the remote controller.

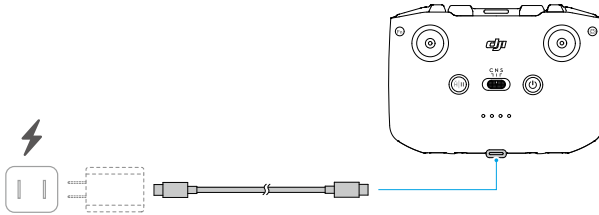

-
- ⚠ • Fully charge the remote controller before each flight. The remote controller sounds an alert when the battery level is low.
 - Fully charge the battery at least once every three months to maintain the battery's health.
-

Controlling the Gimbal and Camera

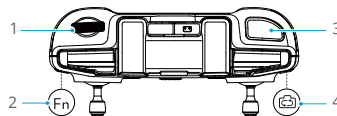

1. **Gimbal Dial:** Control the tilt of the gimbal.
2. **Customizable Button:** Press and hold the customizable button and then use the gimbal dial to zoom in or out.

- 3. **Shutter/Record Button:** Press once to take a photo or to start or stop recording.
- 4. **Photo/Video Button:** Press once to switch between photo and video mode.

Flight Mode Switch

Toggle the switch to select the desired flight mode.

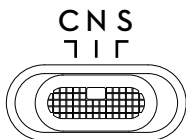

Position	Flight Mode
S	Sport Mode
N	Normal Mode
C	Cine Mode

Flight Pause/RTH Button

Press once to make the aircraft brake and hover in place.

Press and hold the button until the remote controller beeps and starts RTH. The aircraft will return to the last recorded Home Point. Press the button again to cancel RTH and regain control of the aircraft.

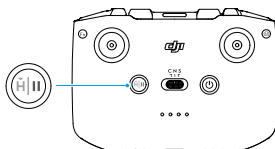

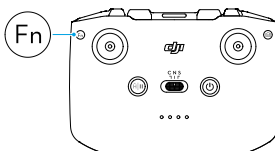

Customizable Button

To view and set the button function, go to camera view in DJI Fly, and tap *** > Control > Button Customization.



Battery Level LEDs

Blinking Pattern	Battery Level
	76-100%

Blinking Pattern	Battery Level
	51-75%
	26-50%
	0-25%

Remote Controller Alert

The remote controller sounds an alert during RTH, which cannot be cancelled. The remote controller sounds an alert when the battery level of the remote controller is low. A low battery level alert can be cancelled by pressing the power button. When the battery level is critically low, the alert cannot be cancelled.

There will be an alert if the remote controller is not used for a period while it is powered on but is not connected to the aircraft or the DJI Fly app on the mobile device. The remote controller will automatically power off after the alert stops. Move the control sticks or press any button to cancel the alert.

Optimal Transmission Zone

The signal between the aircraft and the remote controller is most reliable when the antennas are positioned in relation to the aircraft as illustrated below. If the signal is weak, adjust the remote controller orientation, or fly the aircraft closer to the remote controller.

Optimal Transmission Zone

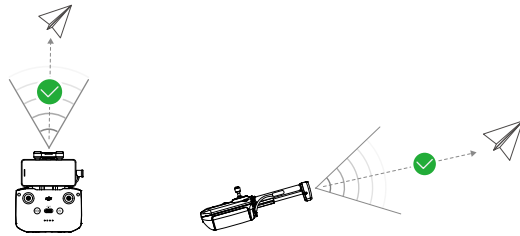

Weak Signal

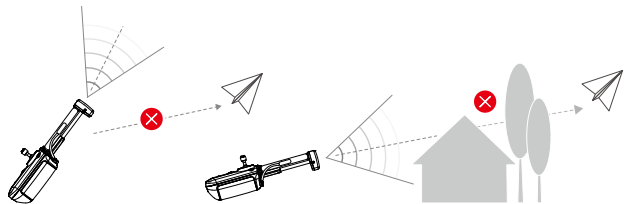

- ⚠ • DO NOT use other wireless devices operating at the same frequency as the remote controller. Otherwise, the remote controller will experience interference.
 - A prompt will be displayed in DJI Fly if the transmission signal is weak during flight. Adjust the remote controller orientation according to the attitude indicator display to make sure that the aircraft is in the optimal transmission range.
-

Linking the Remote Controller

The remote controller is already linked to the aircraft when purchased together as a combo. Otherwise, follow the steps below to link the devices.

1. Power on the aircraft and the remote controller.
2. Launch DJI Fly.
3. In camera view, tap *** > **Control** > **Re-pair to Aircraft**. During linking, the remote controller beeps.
4. Press and hold the power button of the aircraft for more than four seconds. The aircraft beeps, and its battery level LEDs blink in sequence to indicate it is ready to link. The remote controller will beep twice to indicate linking is successful.

-
- 💡 • Make sure the remote controller is within 0.5 m of the aircraft during linking.
 - The remote controller will automatically unlink from an aircraft if a new remote controller is linked to the same aircraft.
-

Appendix

6 Appendix

6.1 Specifications

Visit the following website for specifications.

<https://www.dji.com/flip/specs>

6.2 Compatibility

Visit the following website to get the information on compatible products.

<https://www.dji.com/flip/faq>

6.3 Firmware Update

Use DJI Fly or DJI Assistant 2 (Consumer Drones Series) to update the aircraft and the remote controller firmware.

Using DJI Fly

When connecting the aircraft or remote controller to DJI Fly, you will be notified if a new firmware update is available. To start updating, connect your remote controller or mobile device to the internet and follow the on-screen instructions. Note that you cannot update the firmware if the remote controller is not linked to the aircraft. An internet connection is required.

Using DJI Assistant 2 (Consumer Drones Series)

Use DJI Assistant 2 (Consumer Drones Series) to update the aircraft and the remote controller separately.

1. Power on the device. Connect the device to a computer with a USB-C cable.
2. Launch DJI Assistant 2 (Consumer Drones Series) and log in with your DJI account.
3. Select the device and click **Firmware Update** on the left side of the screen.
4. Select the firmware version.
5. Wait for the firmware to download. The firmware update will start automatically. Wait for the firmware update to complete.

 • The battery firmware is included in the aircraft firmware. Be sure to update all batteries.

- Make sure to follow all the steps to update the firmware, otherwise the update may fail.
- Make sure the computer is connected to the internet during the update.
- DO NOT unplug the USB-C cable during an update.
- The firmware update will take approximately 10 minutes. During the update process, it is normal for the gimbal to go limp, the aircraft status indicators to blink, and the aircraft to reboot. Wait patiently for the update to complete.

Visit the following link and refer to the *Release Notes* for firmware update information:

<https://www.dji.com/flip/downloads>

6.4 Flight Recorder

Flight data including flight telemetry, aircraft status information, and other parameters are automatically saved to the internal data recorder of the aircraft. The data can be accessed using DJI Assistant 2 (Consumer Drones Series).

6.5 Post-Flight Checklist

- Make sure to perform a visual inspection so that the aircraft, remote controller, gimbal camera, Intelligent Flight Batteries, and propellers are in good condition. Contact DJI support if any damage is noticed.
- Make sure that the camera lens and vision system sensors are clean.
- Make sure to store aircraft correctly before transporting it.

6.6 Maintenance Instructions

To avoid serious injury to children and animals, observe the following rules:

1. Small parts, such as cables and straps, are dangerous if swallowed. Keep all parts out of reach of children and animals.
2. Store the Intelligent Flight Battery and remote controller in a cool, dry place away from direct sunlight to ensure the built-in LiPo battery does NOT overheat. Recommended storage temperature: between 22° and 28° C (71° and 82° F) for storage periods of more than three months. Never store in environments outside the temperature range of -10° to 45° C (14° to 113° F).

3. DO NOT allow the camera to come into contact with or become immersed in water or other liquids. If it gets wet, wipe dry with a soft, absorbent cloth. Turning on an aircraft that has fallen in water may cause permanent component damage. DO NOT use substances containing alcohol, benzene, thinners, or other flammable substances to clean or maintain the camera. DO NOT store the camera in humid or dusty areas.
4. Check every aircraft part after any crash or serious impact. If there are any problems or questions, contact a DJI authorized dealer.
5. Regularly check the Battery Level Indicators to see the current battery level and overall battery life. The battery is rated for 200 cycles. It is not recommended to continue use afterward.
6. Make sure to transport the aircraft with the arms folded when powered off.
7. Make sure to transport the remote controller with antennas folded when powered off.
8. The battery will enter sleep mode during long-term storage. Charge the battery to exit from sleep mode.
9. Store the aircraft, remote controller, battery, and charger in a dry environment.
10. Remove the battery before servicing the aircraft (e.g., cleaning or attaching and detaching the propellers). Make sure that the aircraft and the propellers are clean by removing any dirt or dust with a soft cloth. Do not clean the aircraft with a wet cloth or use a cleanser that contains alcohol. Liquids can penetrate the aircraft housing, which can cause a short circuit and destroy the electronics.

6.7 Troubleshooting Procedures

1. How to solve the gimbal drift issue during flight?

Calibrate IMU and compass in DJI Fly. If the problem persists, contact DJI Support.

2. No function

Check if the Intelligent Flight battery and the remote controller are activated by charging. If the problems persist, contact DJI Support.

3. Power-on and start-up problems

Check if the battery has power. If yes, contact DJI Support if it cannot be started normally.

4. Firmware update issues

Follow the instructions in the user manual to update the firmware. If the firmware update fails, restart all the devices and try again. If the problem persists, contact DJI Support.

5. Procedures to reset to factory default

Use the DJI Fly app to reset to factory default settings.

6. Shutdown and power-off problems

Contact DJI Support.

7. How to detect careless handling or storage in unsafe conditions

Contact DJI Support.

6.8 Risks and Warnings

When the aircraft detects a risk after powering on, there will be a warning prompt on DJI Fly. Pay attention to the list of situations below.

- If the location is not suitable for takeoff.
- If an obstacle is detected during flight.
- If the location is not suitable for landing.
- If the compass and IMU experience interference and need to be calibrated.
- Follow the on-screen instructions when prompted.

6.9 Disposal



Observe the local regulations related to electronic devices when disposing of the aircraft and remote controller.

Battery Disposal

Dispose of the batteries in specific recycling containers only after a complete discharge. DO NOT dispose of the batteries in regular trash containers. Strictly follow the local regulations regarding the disposal and recycling of batteries.

Dispose of a battery immediately if it cannot be powered on after over-discharging.

If the power button is disabled and the battery cannot be fully discharged, contact a professional battery disposal/recycling agency for further assistance.

6.10 C0 Certification

DJI Flip is compliant with C0 certification requirements. There are some requirements and restrictions when using DJI Flip in EU member states, EFTA member states (EFTA, i.e. Norway, Iceland, Liechtenstein, Switzerland) and Georgia.

Model	DF1A0424
UAS Class	C0
Maximum Take-Off Mass (MTOM)	249 g
Maximum Propeller Speed	20500 RPM

MTOM Statement

The MTOM of DJI Flip (Model DF1A0424) is 249 g to comply with C0 requirements.

You must follow the instructions below to comply with the MTOM requirements.

- DO NOT add any payload to the aircraft except the items listed in the List of Items including qualified accessories section.
- DO NOT use any non-qualified replacement parts, such as intelligent flight batteries or propellers, etc.
- DO NOT retrofit the aircraft.

List of Items, including qualified accessories

Item	Model Number	Dimensions	Weight
Propellers	4022F	101.6×55.8 mm (diameter×thread pitch)	0.45 g (each piece)
Intelligent Flight Battery	BWX141-3110-7.16	79.7×57.8×27.4 mm	Approx. 83.5 g
ND Filters Set* (ND 16/64/256)	N/A	19.6×14.2×4.6 mm	0.34 g (individual)
microSD Card*	N/A	15×11×1.0 mm	Approx. 0.3 g

* Not included in the original packaging. For how to install and use the ND Filters Set, refer to the Product Information for the ND Filters Set.

List of Spare and Replacement Parts

- DJI Flip Propellers
- DJI Flip Intelligent Flight Battery

Remote Controller Warnings

DJI RC 2

The remote controller indicator will glow red after disconnecting with the aircraft. DJI Fly will issue a warning prompt after disconnecting from the aircraft. The remote controller will beep and power off automatically after disconnecting from aircraft and with no operation for a long time.

DJI RC-N3

The battery level LEDs will start blinking slowly after disconnecting from the aircraft. DJI Fly will issue a warning prompt after disconnecting from the aircraft. The remote controller will beep and power off automatically after disconnecting from the aircraft and with no operation for a long time.

-
- ⚠ • Avoid interference between the remote controller and other wireless equipment. Make sure to turn off the Wi-Fi on nearby mobile devices. Land the aircraft as soon as possible if there is interference.
 - Release the control sticks or press the flight pause button if an unexpected operation occurs.
 - When using Mobile App Control, DJI Fly will issue a warning prompt after disconnecting from the aircraft.
-

EASA Notice

Make sure to read the Drone Information Notices document included in the package before use.

Visit the link below for more EASA notice information on traceability.

<https://www.easa.europa.eu/en/document-library/general-publications/drones-information-notices>

Original Instructions

This manual is provided by SZ DJI Technology, Inc., and the content is subject to change.

Address: Lobby of T2, DJI Sky City, No. 53 Xianyuan Road, Xili Community, Xili Street, Nanshan District, Shenzhen, China, 518055.

6.11 Aftersales Information

Visit <https://www.dji.com/support> to learn more about aftersales service policies, repair services, and support.



Contact
DJI SUPPORT

This content is subject to change without notice.
Download the latest version from



<https://www.dji.com/flip/downloads>

If you have any questions about this document, please contact DJI by sending a message to **DocSupport@dji.com**.

DJI is a trademark of DJI.
Copyright © 2025 DJI All Rights Reserved.