

# MAVIC 2 PRO

## Quick Start Guide

V1.0

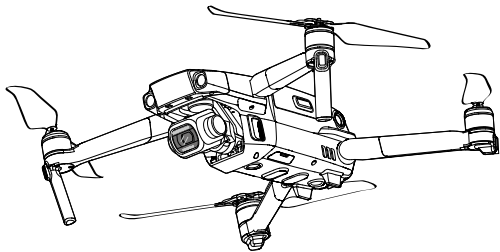

## Aircraft

The DJI™ MAVIC™ 2 Pro features omnidirectional Vision Systems and Infrared Sensing Systems\*, and a fully stabilized 3-axis gimbal with a 1" CMOS sensor camera (jointly developed by DJI and Hasselblad) that shoots 4K video and 20-megapixel photos. DJI signature technologies such as Obstacle Sensing and Intelligent Flight Modes like HyperLapse, ActiveTrack™ 2.0, QuickShot, Panorama, and Advanced Pilot Assistance Systems, help you capture complex shots effortlessly. The Mavic 2 Pro boasts a maximum flight speed of 44.7 mph (72 kph) and a maximum flight time\*\* of 31 minutes.

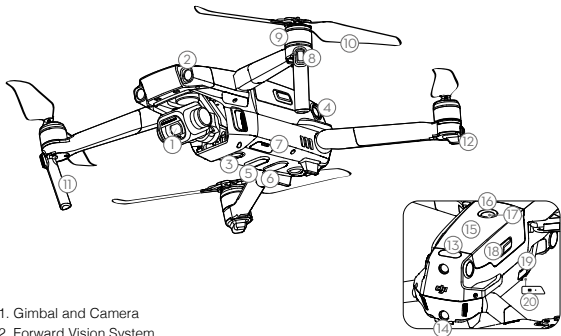

- |                                     |                                    |  |
|-------------------------------------|------------------------------------|--|
| 1. Gimbal and Camera                | 9. Motors                          | 16. Battery Level LEDs                   |
| 2. Forward Vision System            | 10. Propellers                     | 17. Power Button                         |
| 3. Downward Vision System           | 11. Antennas                       | 18. Battery Buckles                      |
| 4. Lateral Vision System            | 12. Aircraft Status Indicator      | 19. USB-C Port                           |
| 5. Downward Infrared Sensing System | 13. Upward Infrared Sensing System | 20. Link Button/Linking Status Indicator |
| 6. Auxiliary Bottom Light           | 14. Backward Vision System         |  |
| 7. microSD Card Slot                | 15. Intelligent Flight Battery     |  |
| 8. Front LEDs                       |                                    |  |

\* The Vision Systems and Infrared Sensing Systems are affected by surrounding conditions. Read the Disclaimer and Safety Guidelines, User Manual, and watch the tutorial videos in the DJI GO™ 4 app or on the official DJI website to learn more. <http://www.dji.com/mavic-2>

\*\* Maximum flight time was tested in an environment with no wind while flying at a consistent 15.5 mph (25 kph). This value is for reference only.

## Remote Controller

Built into the remote controller is the DJI's long-range transmission technology OCUSYNC™ 2.0, offering a maximum transmission range of 5 mi (8 km) and displaying video from the aircraft to the DJI GO 4 app on your mobile device at up to 1080p. An on-board LCD screen gives real-time aircraft data information and the detachable control sticks make the remote controller easier to store.

Maximum run time: 2 hours and 15 minutes\*



Folded

1. LCD Screen
2. Flight Pause Button
3. 5D Button
4. Removable Control Sticks
5. Power Button
6. Antennas
7. RTH Button
8. Control Sticks Storage Slot
9. Reserve Video-Downlink Port (USB)
10. Mobile Device Clamp
11. Flight Mode Switch

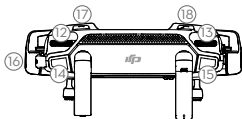
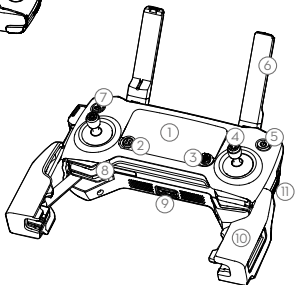

12. Gimbal Dial
13. Aperture/Shutter Adjustment Dial
14. Record Button
15. Focus/Shutter Button
16. Video-Downlink/Power Port (micro USB)
17. C1 Button (Customizable)
18. C2 Button (Customizable)

\* The remote controller is able to reach its maximum transmission distance (FCC) in a wide-open area with no electromagnetic interference at an altitude of about 400 ft (120 m). The maximum runtime is tested in a laboratory environment. This value is for reference only.

## 1. Download the DJI GO 4 App and Watching Tutorial Videos

Search "DJI GO 4" in the App Store or Google Play or scan the QR code below to download the app on your mobile device.



DJI GO 4

Watch the tutorial videos at [www.dji.com/mavic-2](http://www.dji.com/mavic-2) or in DJI GO 4 by tapping the icon in the top right corner of your screen.



Tutorial videos



DJI GO 4 is compatible with iOS 9.0 (or later) or Android 4.4 (or later).

---

## 2. Preparing the Aircraft

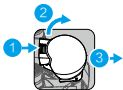

Remove the gimbal cover from the camera.



Unfold the front arms.



Unfold the rear arms.



Marked      Unmarked

Match the propellers to motors.



Press the propellers down firmly and rotate in the lock direction.



Unfolded



Unfold the front arms and the propellers before the rear ones. All arms and propellers must be unfolded before takeoff.

### 3. Charging the Batteries

Use the provided charger to fully charge the Intelligent Flight Battery before first use.

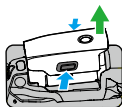

Remove the Intelligent Flight Battery

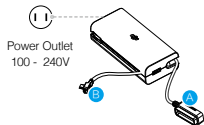

Power Outlet  
100 - 240V



Charging Time:  
~1 hour 30 minutes

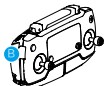

Charging Time:  
~2 hour 15 minutes



Remove the remote controller cable before charging.

---

#### • Checking the Battery Levels and Powering On/Off

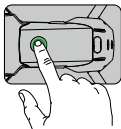

Press once to check the battery level.  
Press, then press and hold to turn on/off.

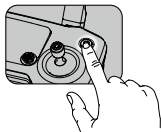

BAT 100 PCT

Press once to check the battery level on  
the LCD screen.

Press once, then press and hold to turn on/  
off the remote controller.

## 4. Preparing the Remote Controller

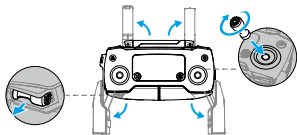

Unfold the antennas and mobile device clamps, then attach the control sticks.



Place one end of the RC cable to the end of the slot.

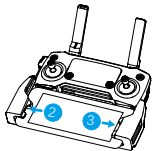

Attach your mobile device within the clamps.



Set the antennas parallel to each other

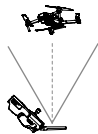
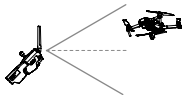

Optimal Transmission Range

- Ensure the control sticks are firmly mounted.
- The remote controller cable with the Lightning connector is mounted by default. Use the appropriate cable for your mobile device to connect to the remote controller. When using an iPad or tablet, use the USB port on the remote controller.
- Do not use the Micro USB and the USB ports simultaneously for linking video.

## 5. Preparing for Takeoff



Power on the remote controller



Power on the aircraft



Launch DJI GO 4



Use your DJI account to activate the aircraft. Activation requires an internet connection.

---

## 6. Flight

Before taking off, make sure the Aircraft Status Bar in DJI GO 4 displays "Ready to Go".

Ready to Go (GPS)

• Auto Takeoff / Landing



Auto Takeoff



Auto Landing

• Manual Takeoff / Landing

Combination stick command to start/stop the motors



OR



Left stick up (slowly)  
to take off



Left stick down (slowly) until you touch the ground  
Hold a few seconds to stop the motors



The motors can only be stopped mid-flight when the flight controller detects critical error.

## • Remote Controller Operation

The default flight control is known as Mode 2. The left stick controls the aircraft's altitude and heading, while the right stick controls its forward, backward, left and right movements. The gimbal dial controls the camera's tilt.

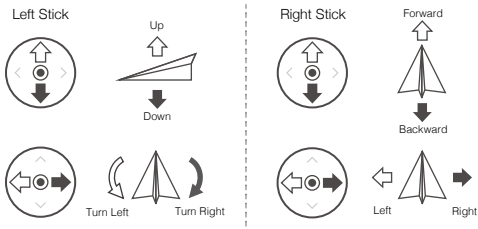

 Press the Flight Pause button for emergency braking during flight.

---

## • In DJI GO 4

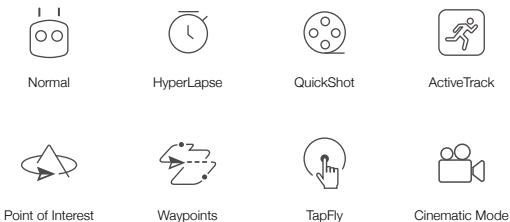

 • Watch the tutorials in DJI GO 4 or at the official DJI website to learn more.  
• Always set an appropriate RTH altitude before takeoff. When the aircraft is returning to the Home Point, you should guide it with the control sticks.



## 7. Fly Safe



Fly in Open  
Areas



Strong GPS  
Signal



Maintain Line of  
Sight



Fly Below 400 Feet  
(120 m)



Avoid flying over or near obstacles, crowds, high voltage power lines, trees or bodies of water.

DO NOT fly near strong electromagnetic sources such as power lines and base stations as it may affect the onboard compass.



DO NOT use the aircraft in adverse weather conditions such as rain, snow, fog and wind speeds exceeding 10 m/s or 22 mph.



Stay away from the rotating propellers  
and motors.



No Fly Zone

Learn more at:  
<http://flysafe.dji.com/no-fly>



It's important to understand basic flight guidelines, for the safety of both you and those around you. Don't forget to read the *Disclaimer and Safety Guidelines*.

## Specifications

### • Aircraft

Weight	907 g
Max Speed	44.7 mph (72 kph) in Sport mode without wind
Max Service Ceiling Above Sea Level	19685 ft (6000 m)
Operating Temperature	14° to 104° F (-10° to 40° C)
GNSS	GPS + GLONASS
Operating Frequency	2.4-2.4835 GHz; 5.725-5.850 GHz
Transmitter Power (EIRP)	2.4 GHz FCC: ≤26 dBm; CE/MIC: ≤20 dBm; SRRC: ≤20 dBm 5.8 GHz FCC: ≤26 dBm; CE: ≤14 dBm; SRRC: ≤26 dBm

### • Gimbal

Controllable Range	Pitch: -90° to +30°
--------------------	---------------------

### • Camera

Sensor	1" CMOS; Effective pixels: 20M
Lens	FOV: approx. 77° 35 mm format equivalent: 28 mm Aperture: f/2.8-f/11 Focus: 1 m to ∞
ISO Range	Video: 100-6400 Photo: 100-3200 (auto); 100-12800 (manual)
Electronic Shutter Speed	8-1/8000 s
Max Image Size	5472×3648
Still Photography Modes	Single shot Burst shooting: 3/5 frames Auto Exposure Bracketing (AEB): 3/5 bracketed frames at 0.7 EV Bias Interval
Video Recording Modes	4K Ultra HD: 3840×2160 24/25/30p 2.7K: 2688×1512 24/25/30/48/50/60p FHD: 1920×1080 24/25/30/48/50/60/120p
Video Storage Bitrate	100 Mbps
Photo	JPEG, DNG (RAW)
Video	MP4, MOV (MPEG-4 AVC/H.264, HEVC)
Supported SD Cards	microSD Max Capacity: 128 GB (UHS-I Speed Grade 3 rating required)

### • Remote Controller

Operating Frequency	2.4-2.4835 GHz; 5.725-5.850 GHz
Max Transmission Distance (Unobstructed and free of interference)	FCC: 5 mi (8 km); CE/MIC: 3.1 mi (5 km); SRRC: 3.1 mi (5 km)
Operating Temperature	32° to 104° F (0° to 40° C)
Battery	3950mAh @ 3.83V

Transmitter Power (EIRP)	2.4 GHz FCC: ≤26 dBm; CE/MIC: ≤20 dBm; SRRC: ≤20 dBm 5.8 GHz FCC: ≤26 dBm; CE: ≤14 dBm; SRRC: ≤26 dBm
Operating Voltage	1800mA @ 3.83V (when charging the mobile device)
Supported Mobile Device Size	Thickness supported: 6.5 - 8.5 mm, Max length: 160 mm Supported USB port types: Lightning, Micro USB (Type-B) USB-C
<b>• Charger</b>	
Voltage	17.6±0.1 V
Rated Power	60 W
<b>• Intelligent Flight Battery</b>	
Capacity	3850 mAh
Voltage	17.6 V (max) 15.4 V (typical)
Battery Type	LiPo 4S
Energy	59.29 Wh
Net Weight	Approx. 297 g
Charging Temperature Range	41° to 104° F (5° to 40° C)
Max Charging Power	80 W

---

For more information, read the User Manual:  
<http://www.dji.com/mavic-2>

※ This content is subject to change without prior notice.

# MAVIC 2 PRO



For online support, please scan this code  
with Facebook Messenger



0M6DPARM01UK