

dji NEO 2

User Manual

v1.0 2025.10

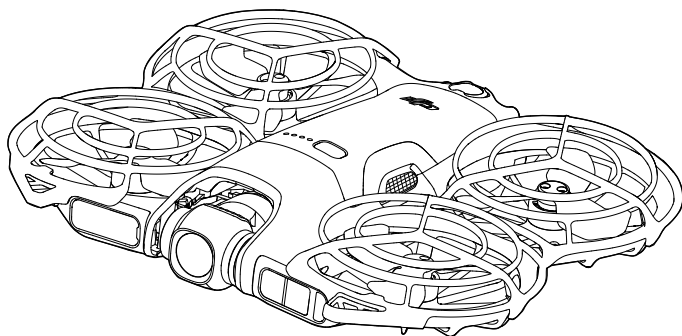



This document is copyrighted by DJI with all rights reserved. Unless otherwise authorized by DJI, you are not eligible to use or allow others to use the document or any part of the document by reproducing, transferring or selling the document. Only refer to this document and the content thereof as instructions to operate DJI products. The document should not be used for other purposes.

In the event of divergence among different versions, the English version shall prevail.

Searching for Keywords

Search for keywords such as “battery” and “install” to find a topic. If you are using Adobe Acrobat Reader to read this document, press Ctrl+F on Windows or Command+F on Mac to begin a search.

Navigating to a Topic

View a complete list of topics in the table of contents. Click on a topic to navigate to that section.

Printing this Document

This document supports high resolution printing.

Using this Manual

Legend

⚠ Important

💡 Hints and Tips

📖 Reference

Read Before Use

DJI™ provides you with tutorial videos and the following documents:

1. *Safety Guidelines*
2. *Quick Start Guide*
3. *User Manual*

It is recommended to watch all the tutorial videos and read the *Safety Guidelines* before using for the first time. Make sure to review the *Quick Start Guide* before using for the first time and refer to this *User Manual* for more information.

Video Tutorials

Go to the address below or scan the QR code to watch the tutorial videos, which demonstrate how to use the product safely:



<https://www.dji.com/neo-2/video>

Download the DJI Fly App

Make sure to use DJI Fly during flight. Scan the QR code to download the latest version.





- The remote controller with screen has the DJI Fly app already installed. You are required to download DJI Fly to your mobile device when using the remote controller without screen.
 - To check the Android and iOS operating system versions supported by DJI Fly, visit <https://www.dji.com/downloads/djiapp/dji-fly>.
 - The interface and functions of DJI Fly may vary as the software version is updated. Actual user experience is based on the software version used.
 - For increased safety, flight is restricted to a height of 98.4 ft (30 m) and a range of 164 ft (50 m) when not connected or logged into the app during flight.
 - App login is valid for 90 days. Connect to the internet and log in again when expired.
-

Download DJI Assistant 2

Download DJI ASSISTANT™ 2 (Consumer Drones Series) at:

<https://www.dji.com/downloads/softwares/dji-assistant-2-consumer-drones-series>



- The operating temperature of this product is -10° to 40° C. It does not meet the standard operating temperature for military-grade application (-55° to 125° C), which is required to endure greater environmental variability. Operate the product appropriately and only for applications that meet the operating temperature range requirements of that grade.
-

Contents

| | |
|--|-----------|
| Using this Manual | 3 |
| Legend | 3 |
| Read Before Use | 3 |
| Video Tutorials | 3 |
| Download the DJI Fly App | 3 |
| Download DJI Assistant 2 | 4 |
| 1 Product Profile | 10 |
| 1.1 Using for the First Time | 10 |
| Preparing the Aircraft | 10 |
| Preparing DJI RC-N3 | 11 |
| Preparing DJI Goggles N3 and DJI RC Motion 3 | 12 |
| Powering on the Goggles | 12 |
| Wearing the Goggles | 13 |
| Preparing DJI RC Motion 3 | 14 |
| Activation | 14 |
| Firmware Update | 15 |
| Preparing DJI Neo 2 Digital Transceiver | 15 |
| 1.2 Overview | 17 |
| Aircraft | 17 |
| DJI RC-N3 Remote Controller | 17 |
| DJI Goggles N3 | 18 |
| DJI RC Motion 3 | 19 |
| 2 Flight Safety | 21 |
| 2.1 Flight Restrictions | 21 |
| GEO (Geospatial Environment Online) System | 21 |
| Flight Limits | 21 |
| Flight Altitude and Distance Limits | 21 |
| GEO Zones | 23 |
| Unlocking GEO Zones | 23 |
| 2.2 Flight Environment Requirements | 23 |
| 2.3 Operating the Aircraft Responsibly | 25 |
| 2.4 Pre-Flight Checklist | 25 |
| 3 Flight Operation | 28 |
| 3.1 Palm Control | 28 |
| Notice | 28 |
| Switch Modes and Adjust Settings | 30 |
| Palm Takeoff and Smart Snaps | 30 |

| | | |
|----------|---|-----------|
| | Gesture Control | 32 |
| | Returning to Palm | 34 |
| 3.2 | Mobile App Control | 35 |
| | Notice | 36 |
| | Connecting DJI Neo 2 | 36 |
| | Voice Control | 37 |
| 3.3 | RC Control | 37 |
| | Auto Takeoff | 37 |
| | Auto Landing | 37 |
| | Starting/Stopping the Motors | 38 |
| | Starting the Motors | 38 |
| | Stopping the Motors | 38 |
| | Stopping the Motors Mid-Flight | 39 |
| | Controlling the Aircraft | 39 |
| | Takeoff/Landing Procedures | 40 |
| | Intelligent Flight Modes | 41 |
| | FocusTrack | 41 |
| | QuickShots | 44 |
| | Cruise Control | 45 |
| | Recording Audio via App | 45 |
| 3.4 | Immersive Motion Control | 46 |
| | Basic Flight | 46 |
| | Taking Off, Braking, and Landing | 48 |
| | Flying Forward and Backward | 48 |
| | Adjusting Aircraft Orientation | 49 |
| | Making the Aircraft Ascend or Descend at an Angle | 50 |
| | Controlling the Gimbal and Camera | 51 |
| | Head Tracking | 51 |
| | Easy ACRO | 52 |
| | Slide | 54 |
| | 180° Drift | 54 |
| | Flip | 54 |
| 3.5 | Video Recording Suggestions and Tips | 55 |
| 4 | Aircraft | 57 |
| 4.1 | Flight Modes | 57 |
| 4.2 | Aircraft Status Indicator | 58 |
| 4.3 | Return to Home | 58 |
| | Notice | 59 |
| | Advanced RTH | 61 |
| | Trigger Method | 61 |
| | RTH Procedure | 62 |

| | |
|---|-----------|
| RTH Settings | 63 |
| Landing Protection | 65 |
| 4.4 Sensing System | 66 |
| Notice | 67 |
| 4.5 Advanced Pilot Assistance Systems | 68 |
| Notice | 69 |
| Landing Protection | 69 |
| 4.6 Propellers and Propeller Guards | 70 |
| Removing and Installing | 70 |
| Notice | 74 |
| 4.7 Intelligent Flight Battery | 75 |
| Notice | 75 |
| Installing/Removing the Battery | 77 |
| Using the Battery | 77 |
| Charging the Battery | 78 |
| Using a Charger | 79 |
| Using the Charging Hub | 79 |
| Battery Protection Mechanisms | 82 |
| 4.8 Gimbal and Camera | 82 |
| Gimbal Notice | 82 |
| Gimbal Angle | 83 |
| Gimbal Operation Modes | 83 |
| Camera Notice | 84 |
| 4.9 Storing and Exporting Photos and Videos | 84 |
| Storing | 84 |
| Exporting | 84 |
| 4.10 QuickTransfer | 85 |
| 5 DJI RC-N3 | 87 |
| 5.1 Operations | 87 |
| Powering On/Off | 87 |
| Charging the Battery | 87 |
| Controlling the Gimbal and Camera | 87 |
| Flight Mode Switch | 88 |
| Flight Pause/RTH Button | 88 |
| Customizable Button | 88 |
| 5.2 Battery Level LEDs | 89 |
| 5.3 Remote Controller Alert | 89 |
| 5.4 Optimal Transmission Zone | 89 |
| 5.5 Linking the Remote Controller | 90 |
| 6 Appendix | 92 |

| | | |
|------|----------------------------|----|
| 6.1 | Specifications | 92 |
| 6.2 | Compatibility | 92 |
| 6.3 | Firmware Update | 92 |
| 6.4 | Flight Recorder | 93 |
| 6.5 | Post-Flight Checklist | 93 |
| 6.6 | Maintenance Instructions | 93 |
| 6.7 | Troubleshooting Procedures | 94 |
| 6.8 | Risks and Warnings | 95 |
| 6.9 | Disposal | 95 |
| 6.10 | C0 Certification | 96 |
| | Remote Controller Warnings | 97 |
| | EASA Notice | 97 |
| | Original Instructions | 97 |
| 6.11 | Aftersales Information | 97 |

Product Profile

1 Product Profile

1.1 Using for the First Time

Click the link or scan the QR code to watch the tutorial videos.



<https://www.dji.com/neo-2/video>

Preparing the Aircraft

Remove the gimbal protector from the camera.

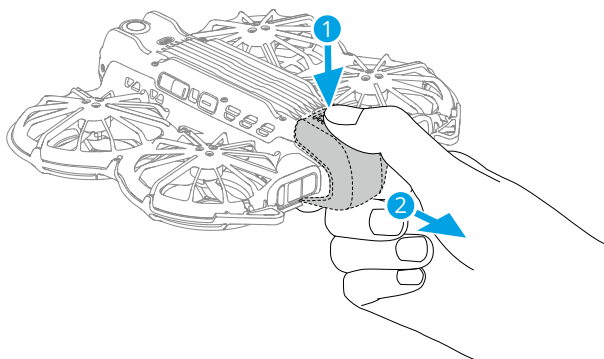

Press, then press and hold the power button to power on DJI Neo 2.

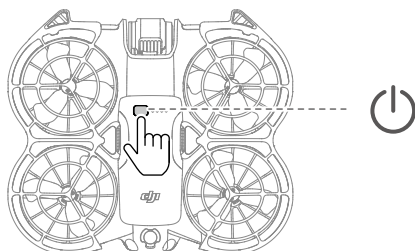

- ⚠ • It is recommended to use the DJI charger to charge the Intelligent Flight Battery. Visit the official DJI website for details.
- Make sure the gimbal protector is removed before powering on the aircraft. Otherwise, it may affect the aircraft self-diagnostics.
- It is recommended to attach the gimbal protector when the aircraft is not in use.

Preparing DJI RC-N3

1. Remove the control sticks from the storage slots and mount them on the remote controller.
2. Pull out the mobile device holder. Choose the appropriate remote controller cable based on the port type of your mobile device (the cable with a USB-C connector is connected by default). Place your mobile device in the holder, then connect the end of the cable without the remote controller logo to your mobile device. Make sure your mobile device is securely in place.

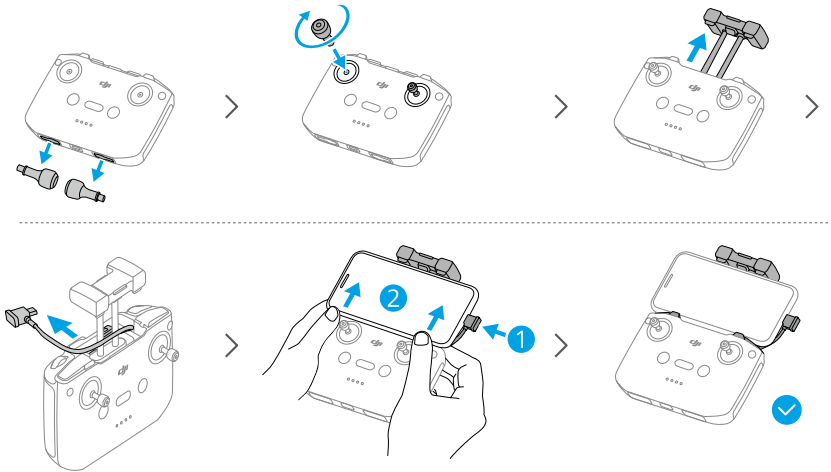

- ⚠ • If a USB connection prompt appears when an Android mobile device is used, select the option to charge only. Other options may cause the connection to fail.
- Adjust the mobile device holder to make sure your mobile device is firmly secure.

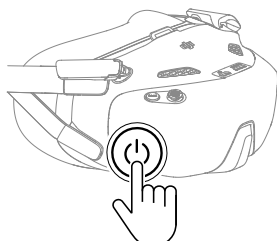

Preparing DJI Goggles N3 and DJI RC Motion 3

Powering on the Goggles



Press the power button once to check the current battery level.



Press once, then press and hold for two seconds to power the goggles on or off.

| Blinking Pattern | Battery Level |
|--|---------------|
|  — Solid Green | 40-100% |
|  — Solid Yellow | 11-39% |
|  — Solid Red | 1-10% |

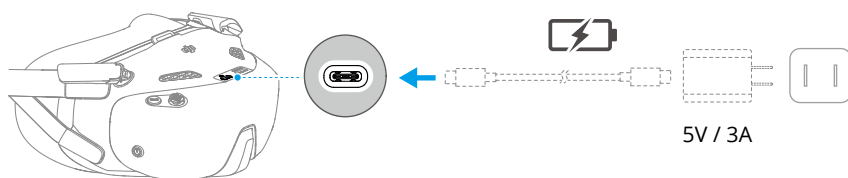
If the battery level is low, it is recommended to use a USB charger to charge the device.



The table below shows the battery level during charging:

| Blinking Pattern | Battery Level |
|---|---------------|
|  — Pulsed Yellow | 1-39% |
|  — Pulsed Green | 40-99% |
|  — Solid Green | 100% |

-  • Using the goggles does not satisfy the requirement of visual line of sight (VLOS). Some countries or regions require a visual observer to assist during flight. Make sure to comply with local laws and regulations when using the goggles.

Wearing the Goggles

- ⚠ • Fold the antennas to avoid damage when the goggles are not in use.
- DO NOT tear or scratch the foam padding, and the soft side of the battery compartment, or other components with sharp objects.
- The power cable is non-detachable. DO NOT pull the power cable with force to avoid damage.

1. Unfold the antennas.

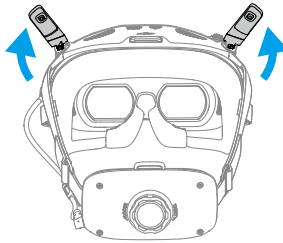

2. Put on the goggles after the devices are powered on.

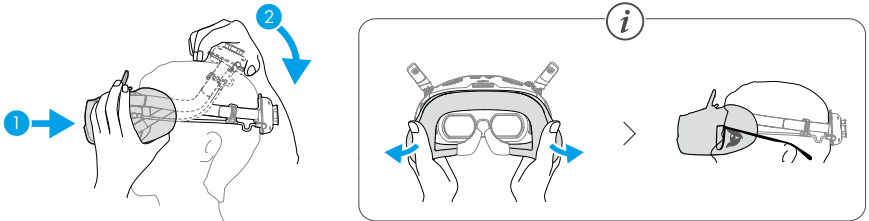

3. Rotate the headband adjustment knob on the battery compartment to adjust the length of the headband.

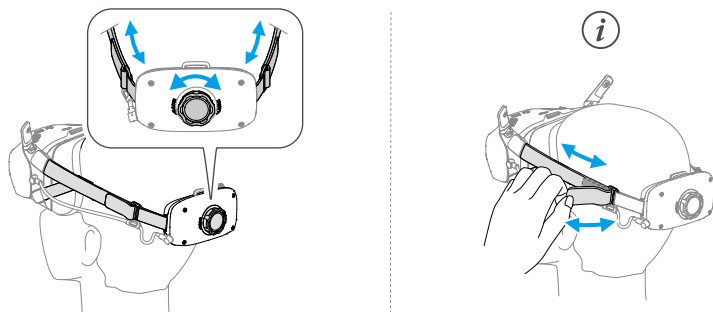

Preparing DJI RC Motion 3

Press the power button once to check the current battery level. Charge before using if the battery level is too low.

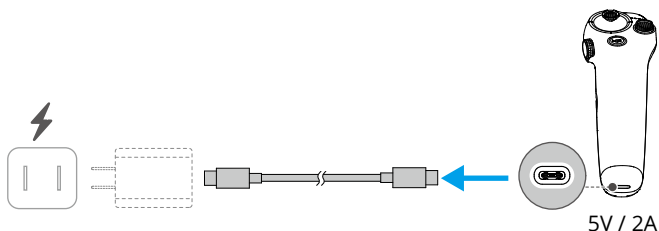

Activation

The product must be activated using the DJI Fly app before being used for the first time. An internet connection is required for activation. The activation method varies depending on the product combo purchased. Follow the corresponding instructions to activate your product.

DJI Neo 2

Press, then press and hold the power button to power on DJI Neo 2. Tap **Connection Guide** on the bottom right corner of the home screen in DJI Fly, select the device model, and then follow the on-screen instructions to complete connection and activation.

Fly More Combo

Press, then press and hold the power button to power on the aircraft and remote controller respectively. Make sure the smartphone is connected to the remote controller, and then follow the on-screen prompts to activate the aircraft using DJI Fly.

You can also follow the method for activating DJI Neo 2 in the previous section to connect the aircraft to the app and activate the aircraft. Once completed, the aircraft can be used with the remote controller.

Motion Fly More Combo

Press the power button once, then press and hold for two seconds to power on the aircraft, goggles, and motion controller. Connect the goggles to the mobile device using a suitable data cable. Run DJI Fly on the mobile device and follow the prompts to activate the DJI devices. Follow the prompts in the goggles if unable to connect the mobile device.

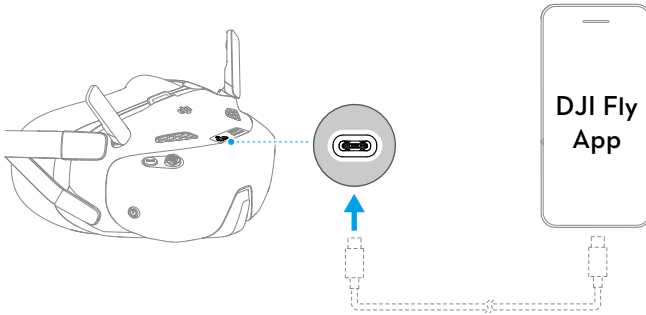

Firmware Update

A prompt will appear in DJI Fly when a firmware update is available. Update the firmware whenever prompted. Otherwise, some features may not be available.

Preparing DJI Neo 2 Digital Transceiver



- Make sure that DJI Neo 2 Digital Transceiver is securely installed on the aircraft before using the remote controller or motion controller.
- Devices purchased as a combo are pre-linked and ready for use upon powering on. Otherwise, follow the steps below to install and link the devices.



Click the link or scan the QR code to watch the tutorial videos.



<https://www.dji.com/neo-2/video>

Installation

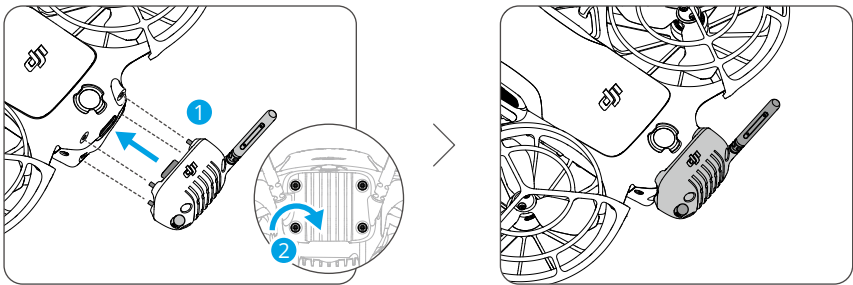

-
- ⚠ • Use the screwdriver provided in the aircraft package to remove and install the screws. Unsuitable screwdrivers may damage the screws.
 - This product does not support hot-swapping. Make sure the transceiver is securely installed before powering on the aircraft.
 - Avoid applying external force to the antenna to prevent deformation.
 - Check to make sure the transceiver screws are tightened after every 30 hours of flight time (approx. 60 flights).
-
- 💡 • After installation, the aircraft can be charged or connected to a computer directly via the transceiver's USB-C port without disassembly.
-

Linking

1. Power on the aircraft and wait for the system self-diagnostics to complete.
2. Enable Bluetooth, Wi-Fi, and location services on the smartphone.
3. Tap **Connection Guide** on the bottom right corner of the home screen in DJI Fly, select the aircraft model, choose connection method and, then follow the on-screen instructions to complete linking with the aircraft.

-
- 💡 If the aircraft fails to establish a linking status, make sure the screws are securely fastened, then restart the aircraft.
-

1.2 Overview

Aircraft

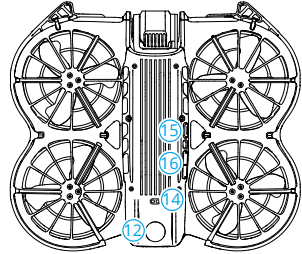
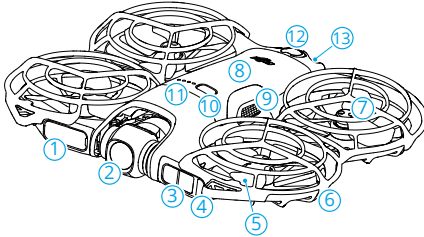

1. Screen
2. Gimbal and Camera
3. Forward-Facing LiDAR^[1]
4. Status Indicator
5. Propellers
6. Propeller Guard
7. Motors
8. Intelligent Flight Battery
9. Battery Buckle
10. Power Button
11. Battery Level LEDs
12. Omnidirectional Monocular Vision System^[2]
13. USB-C Port
14. Downward Infrared Sensing System
15. Takeoff button
16. Select Button

[1] The forward-facing LiDAR meet the human eye safety requirements for Class 1 laser products.

[2] The omnidirectional monocular vision system can sense obstacles in horizontal directions and above.

DJI RC-N3 Remote Controller

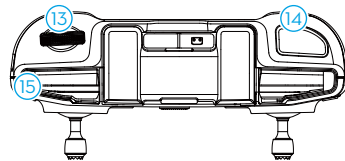
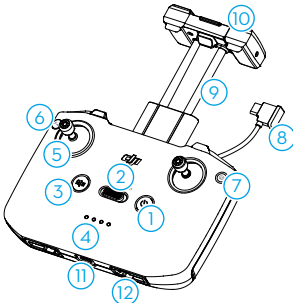

1. Power Button
2. Flight Mode Switch

- | | |
|---|---------------------------------|
| 3. Flight Pause/Return to Home (RTH) Button | 9. Mobile Device Holder |
| 4. Battery Level LEDs | 10. Antennas |
| 5. Control Sticks | 11. USB-C Port |
| 6. Customizable Button ^[1] | 12. Control Stick Storage Slots |
| 7. Photo/Video Button | 13. Gimbal Dial |
| 8. Remote Controller Cable | 14. Shutter/Record Button |
| | 15. Mobile Device Slot |

[1] To view and set the button function, go to camera view in DJI Fly, and tap *** > Control > Button Customization.

DJI Goggles N3

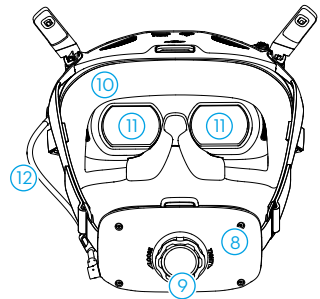
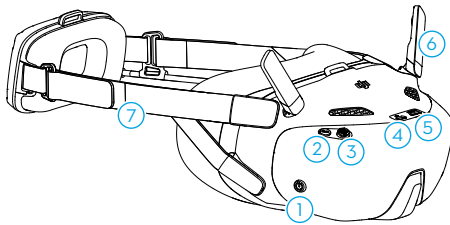

- | | |
|----------------------|-----------------------------|
| 1. Power Button | 7. Headband |
| 2. Back Button | 8. Battery Compartment |
| 3. 5D Button | 9. Headband Adjustment Knob |
| 4. USB-C Port | 10. Foam Padding |
| 5. microSD Card Slot | 11. Lens |
| 6. Antennas | 12. Power Cable |



- When the goggles are connected to a smartphone or a PC, if the devices do not respond after connecting, go to the goggles menu and select **Settings > About**, and enter the OTG Wired Connection mode. If the devices still do not respond after connecting, use a different data cable and try again.
-

DJI RC Motion 3

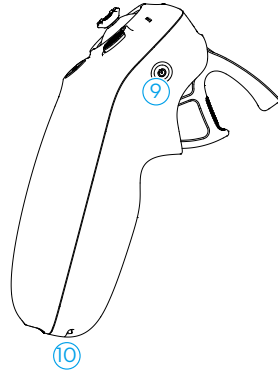
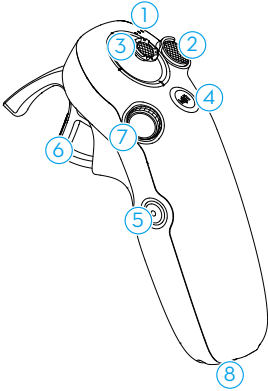

1. Battery Level LEDs
2. Lock Button
3. Joystick
4. Mode Button
5. Shutter/Record Button
6. Accelerator
7. Dial
8. USB-C Port
9. Power Button
10. Lanyard Hole

Flight Safety

2 Flight Safety

After completing pre-flight preparations, it is recommended to train your flying skills and practice flying safely. Pick a suitable area to fly in according to the following flight requirements and restrictions. Strictly abide by local laws and regulations when flying. Read the *Safety Guidelines* before flight to ensure safe use of the product.

2.1 Flight Restrictions

GEO (Geospatial Environment Online) System

The DJI Geospatial Environment Online (GEO) System is a global information system that provides real-time information on flight safety and restriction updates and prevents UAVs from flying in restricted airspace. Under exceptional circumstances, restricted areas can be unlocked to allow flights. Prior to that, you must submit an unlocking request based on the current restriction level in the intended flight area. The GEO system may not fully align with local laws and regulations. You are responsible for your own flight safety and must consult with the local authorities on the relevant legal and regulatory requirements before requesting to unlock a restricted area. For more information about the GEO system, visit <https://fly-safe.dji.com>.

Flight Limits

For safety reasons, flight limits are enabled by default to help you operate the aircraft safely. You can set flight limits on height and distance. Altitude limits, distance limits, and GEO zones function concurrently to manage flight safety when Global Navigation Satellite System (GNSS) is available. Only altitude can be limited when GNSS is unavailable.

Flight Altitude and Distance Limits

Max altitude restricts the flight altitude of the aircraft, while max distance restricts the flight radius around the Home Point of the aircraft. These limits can be changed in the DJI Fly app for improved flight safety.



- When using Palm Control and Mobile App Control, the max flight altitude is 60 m and the max flight distance is not limited. These limits can not be changed in the DJI Fly app. The following information is suitable for when using the aircraft with the remote control devices.

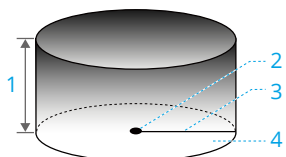

1. Max Altitude
2. Home Point (Horizontal Position)
3. Max Distance
4. Height of aircraft when taking off

Strong GNSS Signal

| | Flight Restrictions | Prompt in DJI Fly App |
|--------------|--|------------------------------|
| Max Altitude | Altitude of the aircraft cannot exceed the value set in DJI Fly. | Max flight altitude reached. |
| Max Distance | The straight-line distance from the aircraft to the Home Point cannot exceed the max flight distance set in DJI Fly. | Max flight distance reached. |

Weak GNSS Signal

| | Flight Restrictions | Prompt in DJI Fly App |
|--------------|---|------------------------------|
| Max Altitude | <ul style="list-style-type: none"> • Altitude is restricted to 30 m from the takeoff point if lighting is sufficient. • Altitude is restricted to 2 m above the ground if lighting is not sufficient and the downward infrared sensing system is functioning. • Altitude is restricted to 30 m from the takeoff point if lighting is not sufficient and the downward infrared sensing system is not functioning. | Max flight altitude reached. |
| Max Distance | No limit | |

- ⚠
- Each time the aircraft is powered on, the altitude limit will be automatically removed as long as the GNSS signal becomes strong (GNSS signal strength ≥ 2), and the limit will not take effect even if the GNSS signal becomes weak afterwards.
 - If the aircraft flies out of the set flight range due to inertia, you can still control the aircraft but cannot fly it any further away.

GEO Zones

The DJI GEO system designates safe flight locations, provides risk levels and safety notices for individual flights, and offers information on restricted airspace. All restricted flight areas are referred to as GEO Zones, which are further divided into Restricted Zones, Authorization Zones, Warning Zones, Enhanced Warning Zones, and Altitude Zones. You can view such information in real-time in DJI Fly. GEO Zones are specific flight areas, including but not limited to airports, large event venues, locations where public emergencies have occurred (such as forest fires), nuclear power plants, prisons, government properties, and military facilities. By default, the GEO system limits takeoffs and flights in zones that may cause safety or security concerns. A GEO Zone map that contains comprehensive information on GEO Zones around the globe is available on the official DJI website: <https://fly-safe.dji.com/nfz/nfz-query>.

Unlocking GEO Zones

Self-Unlocking is intended for unlocking Authorization Zones. To complete Self-Unlocking, you must submit an unlocking request via the DJI FlySafe website at <https://fly-safe.dji.com>. Once the unlocking request is approved, you can synchronize the unlocking license through the DJI Fly app. To unlock the zone, alternatively, you can launch or fly the aircraft directly into the approved Authorization Zone and follow the prompts in DJI Fly to unlock the zone.

Custom Unlocking is tailored for users with special requirements. It designates user-defined custom flight areas and provides flight permission documents specific to the needs of different users. This unlocking option is available in all countries and regions and can be requested via the DJI FlySafe website at <https://fly-safe.dji.com>.

-
-  • To ensure flight safety, the aircraft will not be able to fly out of the unlocked zone after entering it. If the Home Point is outside the unlocked zone, the aircraft will not be able to return home.
-

2.2 Flight Environment Requirements

1. DO NOT fly in severe weather conditions such as strong winds, snow, rain, and fog.
2. Fly in open areas. Tall buildings and large metal structures may affect the accuracy of the onboard compass and GNSS system. When using the aircraft with the remote control device, after takeoff, make sure you are notified with the prompt Home Point is updated before continuing flight. If the aircraft has taken off near buildings, the accuracy of the Home Point cannot be guaranteed. In this case, pay close attention to the current position of the aircraft during auto RTH. When the aircraft is close to the

Home Point, it is recommended to cancel auto RTH and manually control the aircraft to land at an appropriate location.

3. Fly the aircraft within visual line of sight (VLOS). Avoid mountains and trees blocking GNSS signals. Any flight beyond visual line of sight (BVLOS) can be conducted only when the aircraft performance, the knowledge and skills of the pilot, and the operational safety management are compliant with local regulations for BVLOS. Avoid obstacles, crowds, trees, and bodies of water (it is recommended to keep at least 1 m away from water). For safety reasons, DO NOT fly the aircraft near airports, highways, railway stations, railway lines, city centers, or other sensitive areas, unless any permit or approval is obtained under local regulations.
4. When the GNSS signal is weak, fly the aircraft in environments with good lighting and visibility. The vision system may not work properly in poor light conditions. Only fly the aircraft in the daytime.
5. Minimize interference by avoiding areas with high levels of electromagnetism, such as locations near power lines, base stations, electrical substations, and broadcasting towers.
6. Be careful when flying 2 km (6,560 ft) or more above sea level as battery and aircraft performance may be reduced. DO NOT fly above the specified altitude.
7. The braking distance of the aircraft is affected by the flight altitude. The higher the altitude, the greater the braking distance. When flying at high altitudes, you should reserve adequate braking distance to ensure flight safety.
8. GNSS cannot be used on the aircraft in polar regions. Use the vision system instead.
9. DO NOT take off from moving objects such as cars, ships, and airplanes.
10. DO NOT take off from solid-colored surfaces or surfaces with strong reflection such as a car roof.
11. Be careful when taking off in the desert or from a beach to avoid sand entering the aircraft.
12. DO NOT operate the aircraft in an environment at risk of a fire or explosion.
13. Use the aircraft and related devices in dry environments.
14. DO NOT use the aircraft and related devices in the following environments: accident scenes, fires, explosions, floods, tsunamis, avalanches, landslides, earthquakes, areas with dust or sandstorms. During operation, be sure to avoid exposure to salt spray and mold.
15. DO NOT operate the aircraft near bird flocks.

2.3 Operating the Aircraft Responsibly

To avoid serious injury and property damage, observe the following rules:

1. Make sure you are NOT under the influence of anesthesia, alcohol, or drugs or suffering from dizziness, fatigue, nausea, or other conditions that could impair the ability to operate the aircraft safely.
2. After landing, power off the aircraft first, then switch off the remote controller.
3. DO NOT drop, launch, fire, or otherwise project any dangerous payloads on or at any buildings, persons, or animals, which could cause personal injury or property damage.
4. DO NOT use an aircraft that has been accidentally damaged, crashed, or is not in good condition.
5. Make sure to train sufficiently and have contingency plans for emergencies or if an incident occurs.
6. Make sure to have a flight plan. DO NOT fly the aircraft recklessly.
7. Respect the privacy of others when using the camera. Make sure to comply with local privacy laws, regulations, and moral standards.
8. DO NOT use this product for any reason other than general personal use.
9. DO NOT use it for illegal or inappropriate purposes such as spying, military operations, or unauthorized investigations.
10. DO NOT use this product to defame, abuse, harass, stalk, threaten, or otherwise violate legal rights such as the right to privacy and publicity of others.
11. DO NOT trespass onto the private property of others.

2.4 Pre-Flight Checklist

1. Remove the gimbal cover from the camera.
2. Make sure the Intelligent Flight Battery, propellers, and propeller guards are mounted correctly and are firmly secure.
3. Make sure the remote controller, mobile device, and Intelligent Flight Battery are fully charged.
4. Make sure the gimbal and camera are functioning normally.
5. Make sure that there is nothing obstructing the motors and that they are functioning normally.
6. Make sure all camera lenses and sensors are clean.

7. Make sure that DJI Neo 2 Digital Transceiver is securely installed on the aircraft before using the remote controller or motion control.
8. When using Palm Control, make sure that DJI Neo 2 has previously connected to DJI Fly on your smartphone via Wi-Fi and the app works properly.
When using the remote controller, make sure that the remote controller and DJI Fly are successfully connected to the aircraft.
9. Make sure the obstacle avoidance action is set in DJI Fly or the goggles (if in use), and the **Max Altitude**, **Max Distance** and **Auto RTH Altitude** are all set properly according to local laws and regulations.
10. DO NOT install uncertified accessories or external devices, as this may result in product damage or safety hazards.

Flight Operations

3 Flight Operation

DJI Neo 2 supports multiple control methods for various scenarios to meet your needs. Make sure you are familiar with the notice and usage for each control method before flight.

-
- ⚠️ • DO NOT touch DJI Neo 2 mid-flight. Otherwise, DJI Neo 2 may drift and a collision may occur.
 - DO NOT fly DJI Neo 2 immediately after it has been in a collision or severely knocked or shaken. DJI Neo 2 may not be able to perform stable flight.
-

3.1 Palm Control



Click the link or scan the QR code to watch the tutorial video.



<https://www.dji.com/neo-2/video>

In Palm Control, palm takeoff and landing is supported. You can use the buttons on DJI Neo 2 to achieve multiple Smart Snaps. DJI Neo 2 will fly while recording automatically after subject confirmation. You can connect to the DJI Fly app via Wi-Fi to adjust parameters for each mode. The default settings are used as an example.

Notice

-
- 💡 • Power off the remote control devices and goggles that are connected to the aircraft before using Palm Control.
-
- ⚠️ • Make sure that the flight environment meets the flight requirements and that you can control and retrieve DJI Neo 2 immediately when an issue occurs or in an emergency. In situations where DJI may not be able to analyze the cause of the incident, it may not be possible for DJI to provide warranty and other aftersales services.
 - Before using Palm Control, make sure that the aircraft has previously connected to DJI Fly on your smartphone via Wi-Fi. When using Palm Control without the

app, if the aircraft malfunctions mid-flight, you can choose to connect it to DJI Fly via Wi-Fi and control it manually to avoid an accident. If your smartphone cannot connect to the aircraft (e.g., due to Wi-Fi disconnection), power on the remote controller that has been linked with the aircraft to take control.

- Make sure to fly in an open and unobstructed environment without Wi-Fi signal interference.
- When using Palm Control, the maximum flight altitude is 60 m. For safety, maintain visual line of sight (VLOS) within a controlled area.
- DJI Neo 2 will land automatically in the following situations. Make sure to observe the operating environment to avoid being lost or damaged due to the landing.
 - ◆ Critical low battery.
 - ◆ Positioning fails and enters Attitude mode.
 - ◆ detects a collision but does not crash.
- Observe the following rules when taking off from or landing on the palm of your hand:
 - ◆ Operate the aircraft in a windless environment whenever possible.
 - ◆ Hold the the sides of the aircraft body from below when taking off. DO NOT place your fingers in the propeller guards or the propeller rotation range to avoid injury or damage.
 - ◆ DO NOT perform takeoff or landing when moving. Otherwise, may drift and a collision may occur. During landing, may fail to stop the motors when your hand is moving.
 - ◆ DO NOT throw the aircraft during takeoff.
 - ◆ DO NOT attempt to grab the aircraft while it is in flight.
 - ◆ To land on your palm, place your hand under the aircraft to prevent it from falling after landing.
 - ◆ Take off in an environment with sufficient lighting and a richly textured surface. DO NOT fly to an environment that has a significant difference in lighting from the current location.
 - ◆ If the aircraft fails to perform palm takeoff or landing, follow the voice prompt of the aircraft for troubleshooting or connect to the DJI Fly app for details. Voice prompt supports English or Mandarin according to the app language setting for the latest connection. Other languages are not supported.

Switch Modes and Adjust Settings

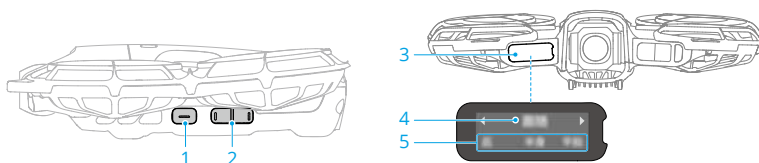

1. Takeoff button
2. Select Button
3. Screen
4. Shooting Mode
5. Shooting Parameters

Switch Shooting Modes

The default mode is Follow after powering on the aircraft for the first time. Press the select button to switch to other modes, such as Dronie, Circle*, and more.

After switching modes, the aircraft will announce the currently selected mode via voice prompt, while the screen will show the current mode and parameters.

* More intelligent shooting modes are available when using Mobile App Control. Update the aircraft firmware to the latest version; otherwise, some shooting modes may not be available.

Set Shooting Parameters

1. Press and hold the select button for 2 seconds to enter parameter settings. The item currently flashing on the screen is the one available for adjustment.
2. Press the Select Button to adjust the value.

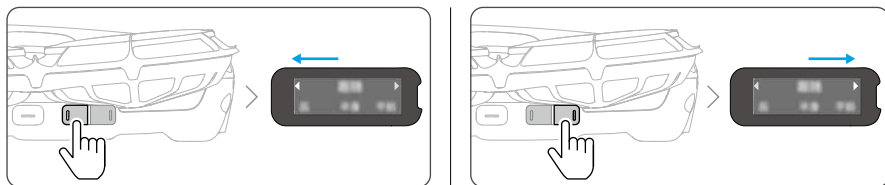

3. Press and hold the select button again to switch to the next setting item.
4. Press the takeoff button to save the current settings and exit.

Palm Takeoff and Smart Snaps

⚠ • Make sure to follow local privacy laws and regulations when using Smart Snaps.

- Smart Snaps only supports the tracking of people.
- Palm takeoff and landing are supported for palm control, mobile app control, and RC control. The difference is that when using RC control, Smart Snaps for palm control are not supported, and subject confirmation is not required before takeoff.

1. Power on DJI Neo 2. Keep it still and wait for the system self-diagnostics to complete.
2. Make sure to leave enough room for maneuvering according to the preset parameters such as distance and height. Press the select button to select the desired mode.
3. Follow the steps below for palm takeoff.

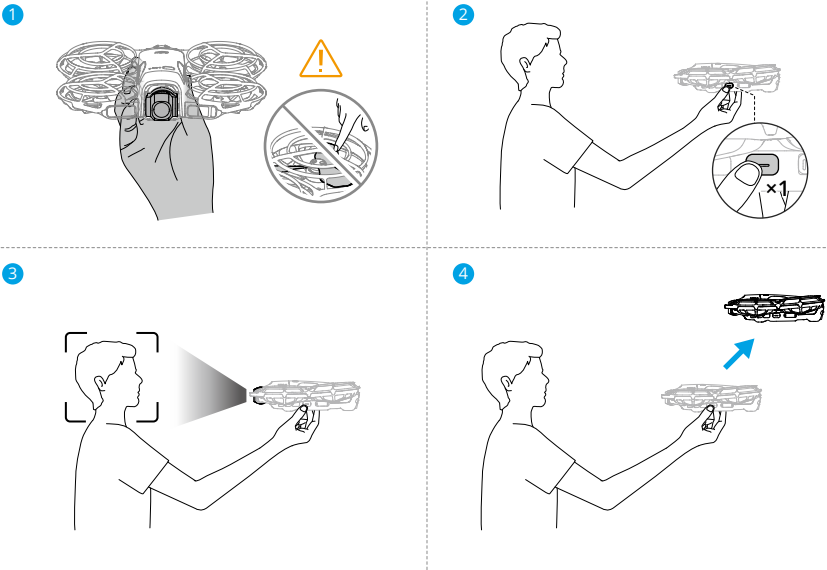

- a. Palm takeoff requires subject confirmation. Hold the sides of the aircraft body from below with the camera facing the subject. Make sure that your hand does not block the camera and there are no obstacles obstructing the takeoff.

 • DO NOT place your fingers within the rotation range of the propellers.

- b. Extend your arm, face the camera toward the subject, and keep it steady. Press and hold the takeoff button. The aircraft will voice prompt the selected mode and the countdown, and then take off automatically. To cancel takeoff, press the takeoff button again before the countdown ends.

- When the subject is obstructed by an obstacle or the environment lighting is not suitable, subject confirmation may fail.
 - When using palm takeoff, the aircraft will fly backward for a short distance after takeoff. Pay attention to the rear of the aircraft to ensure flight safety.
-

4. DJI Neo 2 will start recording or take photos according to the selected mode and its preset parameters.
5. Connect DJI Neo 2 to DJI Fly to view the footage and create short videos.

Gesture Control

Use gestures to adjust aircraft position during Spotlight and ActiveTrack.

- Gesture Control is disabled by default. To enable Gesture Control, connect to DJI Fly app and follow the tutorial to unlock this feature.
 - Make sure that all of the following conditions are met before using Gesture Control.
 - ◆ Only the currently followed or focused subject can control the aircraft.
 - ◆ Keep a horizontal distance of 2-5 m between the aircraft and your palm.
 - ◆ The subject must be fully and clearly visible in the camera view, without any obstructions.
 - ◆ Keep your fingers straight and avoid wearing thick or mitten gloves.
-

Raise your palm towards the camera. Once the status indicator turns blue, you can control the aircraft with gestures.

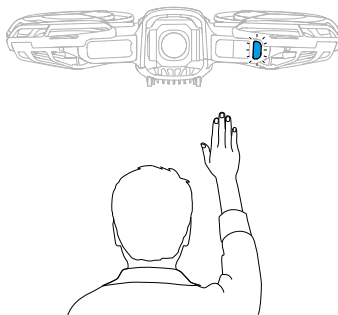

- Move your palm up, down, left, or right to control the aircraft's direction.

- Hold both your palms facing the aircraft. Once the status indicator flashes blue twice, move your hands closer or farther apart and hold to make the aircraft fly forward or backward.

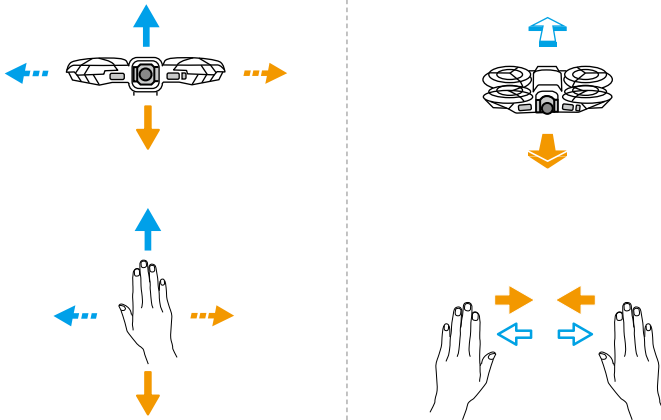

- To exit Gesture Control, make a fist or lower your arm. The status indicator will turn off, and the aircraft will remain hovering. Subsequent following will be at the adjusted direction and distance.
- To switch the follow subject, the original subject should remain stationary and exit Gesture control. The new subject should stand next to the original subject (within half body length), extend one hand, palm facing the aircraft, and hold for over 2s. After switching successfully, the status indicator will remain solid blue, and the aircraft will follow the new subject.

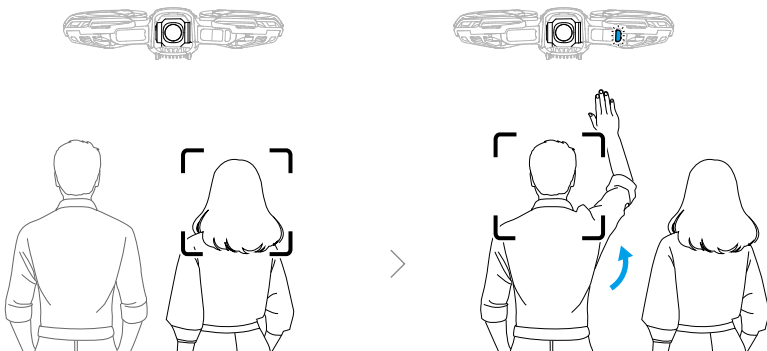

- ⚠️ • The aircraft cannot avoid moving subjects such as people, animals, or vehicles. When using Gesture Control, pay attention to the surrounding environment to ensure flight safety.
 - DO NOT use Gesture Control in areas with small or fine objects (e.g., tree branches or power lines), transparent objects (e.g., water or glass), or monochrome surfaces (e.g., white walls).
 - Gesture Control may fail in lighting conditions that are too dark or too bright. Use gesture-related features within an appropriate lighting range (5-100,000 lux).
-

Returning to Palm

Make sure that the aircraft is hovering in place. Face the aircraft with your palm extended. Ensure your hand is positioned below the aircraft's altitude. Maintain a flat, steady palm with all fingers fully extended. Wait for the aircraft to return and land on your hand.

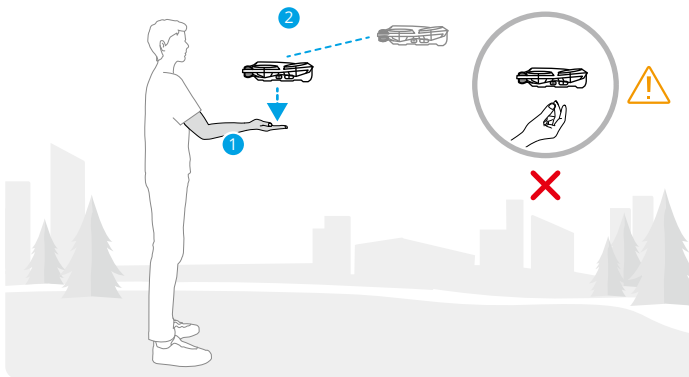

If the aircraft is at a distance, first face the aircraft and extend one arm sideways to signal it to return. After the aircraft flies closer, extend your palm and wait for it to land on your hand.

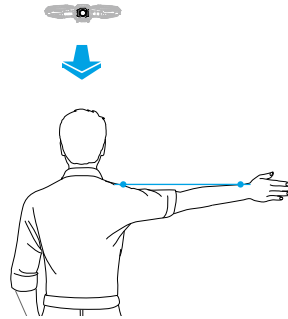

-
- ⚠ • When landing, make sure to fully extend your fingers to avoid touching the propellers. DO NOT attempt to grab the sides of the aircraft body during landing in the same manner as during takeoff.
 - When performing Returning to Palm, keep a horizontal distance of 2-5 m between the aircraft and your palm, and a vertical distance within 2 m.
 - If the aircraft cannot return to palm at a close distance, adjust your location or the aircraft's position using gestures to avoid the aircraft's blind spots, then try again.
 - To recall the aircraft with a single arm extended sideways, keep the aircraft within 10 m horizontally of your arm. Ensure your arm is fully extended when raising. DO NOT raise both arms simultaneously.
-
- 💡 • During palm landing, the aircraft may ascend slightly and then land on the palm. Keep your hand still and extended your fingers during the process.
 - In Follow and Spotlight modes, the aircraft will hover in place if the camera loses the subject while recording. Run DJI Fly on your smartphone via Wi-Fi to connect to mid-flight. The smartphone must have been connected to DJI Fly previously in order to connect. In the Controls view, make sure that the task has already stopped, select **Manual Control** from the mode list, and then land the aircraft using the virtual joysticks.
-

3.2 Mobile App Control



It is recommended to click the link below or scan the QR code to watch the tutorial video.



<https://www.dji.com/neo-2/video>

To use Mobile App Control, connect DJI Neo 2 to the DJI Fly app on the smartphone via Wi-Fi and control DJI Neo 2 in the app. In Mobile App Control, all the functions for Palm Control are available. You can set parameters and perform Smart Snaps in the app. More functions such as manual control, audio recording, and voice control are also supported.

Notice

- 💡 • Before using Mobile App Control, ensure the following:
 - ◆ Power off the remote control devices that are connected to the aircraft so that the liveview can be switched to the mobile app.
 - ◆ Turn off Bluetooth and Wi-Fi on any other smartphones that have previously connected to the aircraft, to prevent the connection interference or takeover.
 - RTH is supported in Mobile App Control. Refer to [Return to Home](#) for details.
-
- ⚠️ • Make sure to fly in an open and unobstructed environment without Wi-Fi signal interference. Otherwise, the app may disconnect from DJI Neo 2 which may affect flight safety.
 - When using Mobile App Control, the max flight altitude of DJI Neo 2 is 60 m. For safety, maintain visual line of sight (VLOS) within a controlled area.
 - DJI Neo 2 will land automatically in the following situations. Make sure to observe the operating environment to avoid DJI Neo 2 to be lost or damaged when landing.
 - ◆ Critical low battery.
 - ◆ Positioning fails and enters Attitude mode.
 - ◆ detects a collision but does not crash.
-

Connecting DJI Neo 2

1. Power on DJI Neo 2 and wait for the system self-diagnostics to complete.
2. Enable Bluetooth, Wi-Fi, and location services on the smartphone.

3. Tap **Connection Guide** on the bottom right corner of the home screen in the app, select the device model, and select **Connect via Mobile Device**.
4. Select the desired device in the search results. The Controls view is displayed after connected successfully. When connecting the smartphone to DJI Neo 2 for the first time, press and hold the power button of DJI Neo 2 to confirm.

-
- You can also tap the QuickTransfer or Wi-Fi Devices panel on the home screen in DJI Fly for Wi-Fi connection.
 - To change the smartphone connected to DJI Neo 2, disable Bluetooth and Wi-Fi on the currently connected smartphone before connecting DJI Neo 2 to the new smartphone.
-

Voice Control

In the Controls view, tap  on the right of the screen under the liveview to enable voice control. Use a voice command to control DJI Neo 2. Tap the corresponding button in the pop-up window to view the common commands. Voice commands support natural language input.



-
- Voice control supports English or Mandarin according to the app language.
 - Turn up the volume on the phone for the optimal experience when using voice control.
-

3.3 RC Control

Auto Takeoff

1. Launch DJI Fly and enter the camera view.
2. Complete all steps in the pre-flight checklist.
3. Tap . If conditions are safe for takeoff, press and hold the button to confirm.
4. The aircraft will take off and hover above the ground.

Auto Landing

1. If conditions are safe to land, tap , then tap and hold  to confirm.
2. Auto landing can be canceled by tapping .

3. If the Downward Vision System is working normally, Landing Protection will be enabled.
4. Motors will stop automatically after landing.

 • Choose an appropriate place for landing.

Starting/Stopping the Motors

Starting the Motors

Perform one of the Combination Stick Commands (CSC) as shown below to start the motors. Once the motors have started spinning, release both sticks simultaneously.

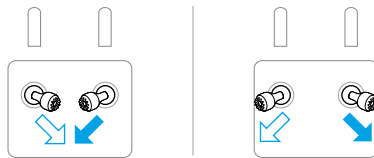

Stopping the Motors

The motors can be stopped in two ways:

Method 1: When the aircraft has landed, push the throttle stick down and hold until the motors stop.

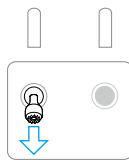

Method 2: When the aircraft has landed, perform one of the CSC as shown below until the motors stop.



Stopping the Motors Mid-Flight

 • Stopping the motors mid-flight will cause the aircraft to crash.

The default setting for **Emergency Propeller Stop** in the DJI Fly app is **Emergency Only**, which means that the motors can only be stopped mid-flight when the aircraft detects that it is in an emergency situation such as the aircraft is involved in a collision, a motor has stalled, the aircraft is rolling in the air, or the aircraft is out of control and is ascending or descending very quickly. To stop the motors mid-flight, perform the same CSC that was used to start the motors. Note that you need to hold the control sticks for two seconds while performing the CSC to stop the motors. **Emergency Propeller Stop** can be changed to **Anytime** in the app. Use this option with caution.

Controlling the Aircraft

The control sticks of the remote controller can be used to control the aircraft movements. The control sticks can be operated in Mode 1, Mode 2, or Mode 3, as shown below.

The default control mode of the remote controller is Mode 2. In this manual, Mode 2 is used as an example to illustrate how to use the control sticks. The more the stick is pushed away from the center, the faster the aircraft moves.

Mode 1

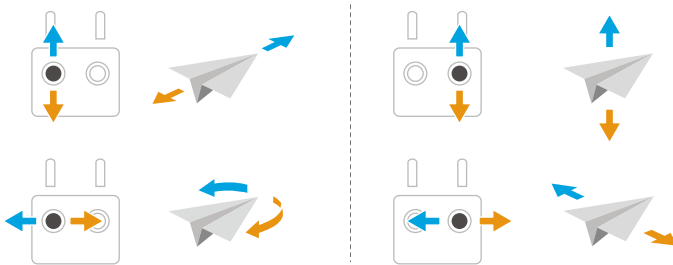

Mode 2

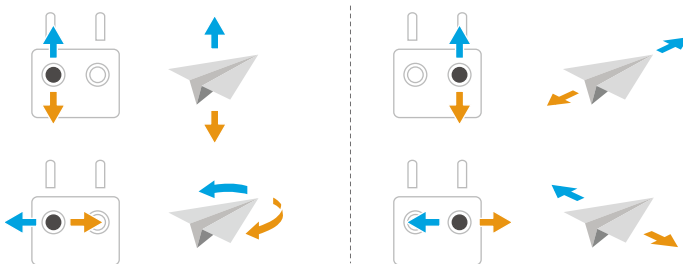

Mode 3

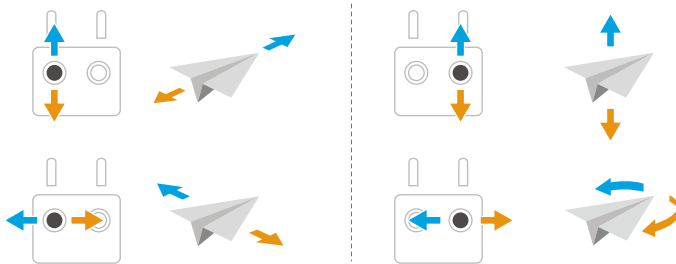

Takeoff/Landing Procedures

- ⚠️ • DO NOT launch the aircraft from your palm or while holding it with your hand.
- DO NOT operate the aircraft when the lighting is too bright or too dark to use the remote controller to monitor flight. You are responsible for the correct adjustment of display brightness and amount of direct sunlight on the screen, as to avoid difficulty in viewing the screen clearly.

1. The pre-flight checklist is designed to help you fly safely. Go through the full pre-flight checklist before each flight.
2. Place the aircraft in an open, flat area with the rear of the aircraft facing towards you.
3. Power on the remote controller and the aircraft.
4. Launch DJI Fly and enter the camera view.
5. Wait for the aircraft self-diagnostics to complete. If DJI Fly does not show any irregular warning, you can start the motors.
6. Push the throttle stick up slowly to take off.
7. To land, hover over a level surface and push the throttle stick down to descend.
8. After landing, push the throttle down and hold until the motors stop.
9. Power off the aircraft before the remote controller.

- 💡 • When using the remote controller, palm takeoff is still supported by pressing and holding the takeoff button on DJI Neo 2. You can also perform palm landing to land the aircraft. Smart Snaps for Palm Control is not supported. The related notice and instructions are similar to those for Palm Control. The difference is that subject confirmation is not required before takeoff. Refer to the [Palm Control](#) section for more information.
-

Intelligent Flight Modes

FocusTrack



- The aircraft does not automatically take photos or record videos while using FocusTrack. Manually control the aircraft to take photos or record videos.
-

Spotlight

Enables the gimbal camera to face toward the subject all the time while you manually control the flight.

When the vision system is working normally, the aircraft will bypass or brake if an obstacle is detected, according to the obstacle avoidance action is set to **Bypass** or **Brake** in DJI Fly.



Obstacle avoidance is disabled in Sport mode.

Supported Subjects:

- Stationary subjects
- Moving subjects (only vehicles and people)

Point of Interest (POI)



Allows the aircraft to fly around the subject.

The aircraft will bypass obstacles regardless of the flight modes or obstacle avoidance action settings in DJI Fly when the vision systems are working normally.

Supported Subjects:

- Stationary subjects
- Moving subjects (only vehicles and people)

ActiveTrack

Tap or slide the track wheel to change tracking direction, and the aircraft will automatically fly from its current position  along the generated trajectory to the selected tracking direction  and keep tracking. Users can also manually adjust the tracking direction, height, and distance using the control sticks. Tap the FocusTrack Settings icon  to set tracking parameters in the app.

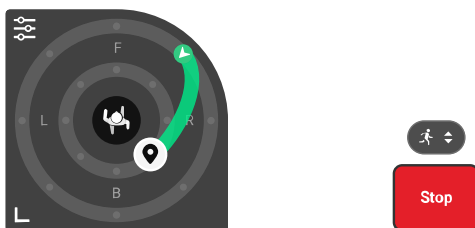

The aircraft will bypass obstacles regardless of the flight modes or obstacle avoidance action settings in DJI Fly when the vision systems are working normally.

Supported Subjects:

Moving subjects (only vehicles and people). Auto mode only supports vehicles and people.

When the subject is a person, the aircraft can automatically match different shooting scenes. Users can also tap the shooting scene icon  to manually switch shooting scene. Based on the selected scene, the aircraft applies corresponding tracking parameters.

-
-  • DO NOT manually set the shooting scene to Standard or Cycling when skiing. Otherwise, the tracking effect and flight safety cannot be guaranteed.
-

In ActiveTrack, the supported distance and height ranges between the aircraft and subject are specified below.

| Subject | People | Vehicles/Boats |
|---------------------|----------|----------------|
| Horizontal Distance | 4-20 m | 4-50 m |
| Height | 0.5-15 m | 0.5-50 m |

-
-  • The aircraft will fly to the supported distance and height range if the distance and height is out of range when ActiveTrack begins.
 - It is recommended that the speed of the dynamic subject should not exceed 12 m/s; otherwise, the aircraft will not be able to track properly.
-



Notice

-
-  • The aircraft cannot avoid moving subjects such as people, animals, or vehicles. When using FocusTrack, pay attention to the surrounding environment to ensure flight safety.

- DO NOT use FocusTrack in areas with small or fine objects (e.g., tree branches or power lines), transparent objects (e.g., water or glass), or monochrome surfaces (e.g., white walls).
 - When the aircraft is following a subject, avoid sudden, high-speed stops by the subject. The aircraft may not be able to brake in time due to inertia, potentially leading to a collision.
 - Always be prepared to press the Flight Pause button on the remote controller or tap  in DJI Fly in order to operate the aircraft manually in case any emergency situation occurs.
 - Be extra vigilant when using FocusTrack in any of the following situations:
 - ◆ The tracked subject is not moving on a level plane.
 - ◆ The tracked subject changes shape drastically while moving.
 - ◆ The tracked subject is out of sight for an extended period.
 - ◆ The tracked subject is in large monochrome areas such as deserts.
 - ◆ The tracked subject has a similar color or pattern to its surrounding environment.
 - ◆ The lighting is extremely dark (<5 lux) or bright (>100,000lux).
 - Make sure to follow local privacy laws and regulations when using FocusTrack.
 - It is recommended to only track vehicles and people (but not children). Fly with caution when tracking other subjects.
 - For the supported moving subjects, vehicles refer to cars. DO NOT track a remote controlled car.
 - The tracking subject may be inadvertently swapped to another subject if they pass nearby each other.
-

Using FocusTrack

Before enabling FocusTrack, make sure the flying environment is open and unobstructed with sufficient light.

Tap the FocusTrack icon  on the left of the camera view, or select the subject on the screen to enable FocusTrack. After enabling, tap the FocusTrack icon  again to exit.



During use, press the Flight Pause button on the remote controller to cancel the subject selection.



QuickShots

QuickShots include multiple shooting modes. The aircraft automatically records according to the selected shooting mode and generates a short video.

Notice

- ⚠ • Make sure there is sufficient space when using Boomerang.
 - Use QuickShots at locations that are clear of buildings and other obstacles. Make sure there are no people, animals, or other obstacles in the flight path.
 - Always pay attention to objects around the aircraft and use the remote controller to avoid collisions or the aircraft being obstructed.
 - DO NOT use QuickShots in any of the following situations:
 - ◆ When the subject is blocked for an extended period of time or outside the visual line of sight.
 - ◆ When the subject is in large monochrome areas such as snow-covered areas or deserts.
 - ◆ When the subject is similar in color or pattern with the surroundings.
 - ◆ When the subject is in the air.
 - ◆ When the subject is moving fast.
 - ◆ The lighting is extremely dark (<5 lux) or bright (>10,000 lux).
 - DO NOT use QuickShots in places close to buildings or where the GNSS signal is weak. Otherwise, the flight path will become unstable.
 - Make sure to follow local privacy laws and regulations when using QuickShots.
-

Using QuickShots

1. Tap the Shooting Mode icon on the right side of the camera view and select QuickShots .
2. After selecting one sub-mode, tap the plus icon or drag-select the subject on the screen. Then tap  to begin shooting. The aircraft will record footage while performing a preset flight movement according to the option selected, and generate a video afterwards. The aircraft will fly back to its original position once recording is finished.
3. Tap  or press the Flight Pause button on the remote controller once. The aircraft will exit QuickShots immediately and hover.

Cruise Control

Cruise Control enables the flight speed and gimbal rotation speed to be locked, making control easier and camera movements smoother. More camera movements, such as spiraling up and gimbal rotation, can be achieved by increasing control stick input and dial input.

-
-  • The obstacle avoidance in cruise control follows the current flight mode. Fly with caution.
-

Using Cruise Control

1. Set one customizable button of the remote controller to Cruise Control.
2. When pushing the control sticks, press the cruise control button, and the aircraft will automatically fly at the current speed.
3. When turning the dial of the remote controller to adjust the gimbal angle, press the cruise control button, and the gimbal will automatically rotate at the current rotation speed in the corresponding direction.



 -  • The gimbal rotation will stop when the gimbal reaches its movement limit.
 - During gimbal rotation, if you adjust the gimbal angle, the gimbal will perform the corresponding adjustment and then continue rotating.

4. Press Flight Pause button on the remote controller once, or tap  to exit cruise control.

Recording Audio via App

In the camera view of the app, tap ***** > Camera** to enable app recording and select the noise reduction effect. Audio will be recorded by the corresponding audio recording device while the aircraft is recording a video. The microphone icon will be displayed in liveview.

Supported audio recording devices include the built-in microphone of the smartphone, DJI Mic 2, and Bluetooth earphones. For a list of compatible Bluetooth devices, please refer to the Downloads page on the DJI Neo 2 official webpage. Audio recording compatibility issues may occur when using some Bluetooth earphones. Make sure to test them before recording.

-
-  • DO NOT turn off the screen or switch to other apps during recording.
 -  • Audio recording can only be enabled or disabled before recording.
-

- When viewing or downloading the videos in the Album view in DJI Fly, the audio recorded using the audio recording function will be automatically merged into the video file.
-

3.4 Immersive Motion Control

- 💡 • This section introduces the flight operation when using DJI Neo 2 with DJI Goggles N3 (hereinafter referred to as goggles) and DJI RC Motion 3 (hereinafter referred to as motion controller). Refer to the corresponding user manuals of the goggles and motion controller for detailed usage.
-

The steps below will help you operate the aircraft properly.

1. Place the aircraft in an open, flat area with the rear of the aircraft facing the user.
2. Power on the goggles, remote control device, and the aircraft.
3. Wait for the aircraft screen to light up before wearing the goggles.
4. Start the motors.
5. Check the flight liveview in the goggles to make sure that there are no warning prompts and that the GNSS signal is strong.
6. Press the lock button twice to start the aircraft motors, then press and hold to make the aircraft take off. The aircraft will ascend to approximately 1.2 m and hover.
7. Press and hold the lock button while the aircraft is hovering to land it automatically and stop the motors.
8. Power off the aircraft, goggles, and remote control device.

Basic Flight

- 💡 • It is recommended to watch the tutorial guide in the goggles before the first flight. Go to **Settings > Control > Motion Controller Flight Tutorial**.
-

Operate the aircraft by using the lock button, joystick, and accelerator of the DJI RC Motion 3.

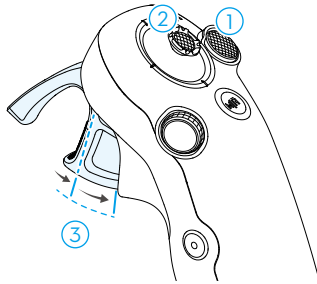

1. Use the lock button to control the takeoff, landing, and braking of the aircraft.
2. Move the joystick to make the aircraft ascend, descend, or move left or right horizontally*.
3. There are two levels of pressure when pressing the accelerator. When gently pressing to the position in the middle of the first and second stop, you can feel a noticeable pause. Press the accelerator to different stops to control different actions of the aircraft.

* When Easy ACRO is not enabled or the Easy ACRO action is selected as Slide.

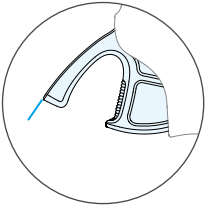

When the accelerator is not pressed, the aircraft will hover.

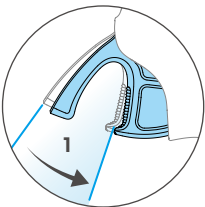

When gently pressing the accelerator to the first stop, you can adjust the aircraft orientation by tilting the motion controller vertically to the left or right. Note that the aircraft will not fly forward at this time.

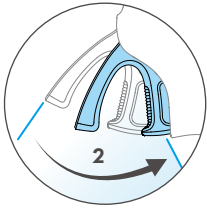

Press the accelerator to the second stop to make the aircraft to fly in the direction of the circle in the goggles.

Taking Off, Braking, and Landing

Takeoff: Press the lock button twice to start the aircraft motors, then press and hold the button again to make the aircraft take off. The aircraft will ascend to approximately 1.2 m and hover.

Braking: Press the lock button during flight to make the aircraft brake and hover in place. Press again to resume flight control.

Landing: Press and hold the lock button while the aircraft is hovering to land it automatically and stop the motors.

- After the aircraft motors have been started by double-pressing the lock button, slowly push the joystick up to make the aircraft take off.
 - When Easy ACRO is disabled, once the aircraft flies to the landing position, gently push the joystick downwards to land the aircraft. After landing, push the joystick down and hold in position until the motors stop.
-

- ⚠️ • If an emergency occurs (such as a collision or the aircraft is out of control) during flight, pressing the lock button four times will trigger Stop Motors Mid-flight, which will stop the aircraft motors immediately. **The Stop Motors Mid-flight function will cause the aircraft to crash. Operate with caution.**
 - To ensure flight safety when using the motion controller, press the lock button once to brake and hover before operating the goggles. Failure to do so is a safety risk and may lead to the aircraft losing control or injury.
-

Flying Forward and Backward

Press or push the accelerator of the motion controller to fly forward or backward. Apply more pressure when pressing or pushing to accelerate. Release to stop and hover.

Press the accelerator to the second stop to make the aircraft fly in the direction of the circle in the goggles.

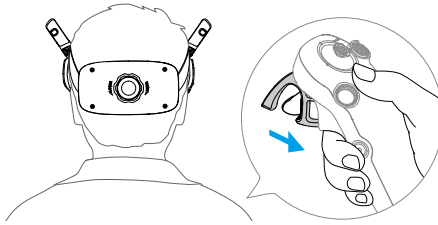
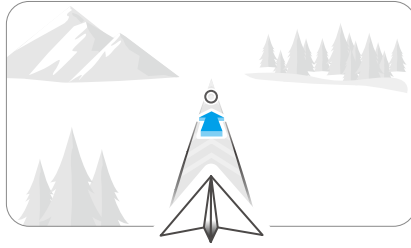

Push the accelerator forward to fly the aircraft in reverse.

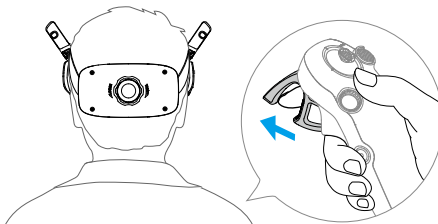
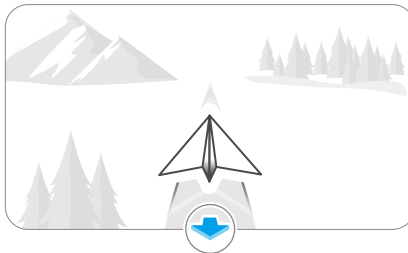

Adjusting Aircraft Orientation

Gently press the accelerator to the first stop and simultaneously tilt the top of the motion controller in either direction to make the aircraft rotate. The greater the tilt angle of the

motion controller, the faster the aircraft will rotate. The circle in the goggles will move left and right and the flight liveview will change accordingly.



Making the Aircraft Ascend or Descend at an Angle

When the aircraft needs to fly at an upward angle, press the accelerator to the second stop while simultaneously tilting the motion controller up.

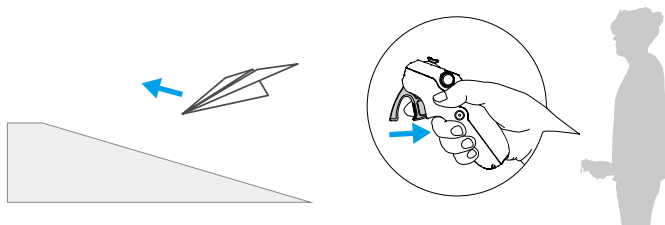

When the aircraft needs to fly at a downward angle, press the accelerator to the second stop while simultaneously tilting the motion controller down.

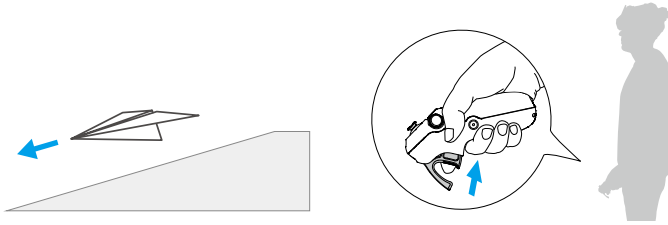

Controlling the Gimbal and Camera

During flight, or when the accelerator is not being pressed and the aircraft is hovering, tilt the motion controller up and down to control the tilt of the gimbal. The tilt of the gimbal changes with the tilt of the motion controller accordingly and is always consistent with the orientation of the motion controller. The circle in the goggles will move up and down and the flight liveview will change accordingly.

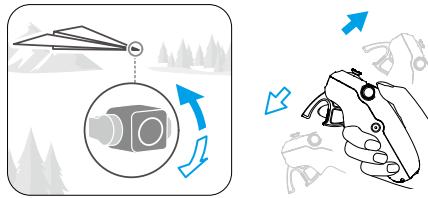

- ⚠ • Before takeoff or when using the lock button to trigger the aircraft to hover, the tilt of the gimbal cannot be controlled.
- Using the dial on the motion controller, scroll up or down to tilt the camera before takeoff or during RTH and landing.

Head Tracking

After enabling head tracking, the horizontal orientation of the aircraft and the gimbal tilt can be controlled using head movements during flight. Open the shortcut menu from the flight liveview, access the quick control menu, and click  to enable Head Tracking.

Once in Head Tracking mode, the motion controller will not be able to control the gimbal tilt, and only control via the aircraft is available. Users can still control the aircraft's heading by tilting the motion controller without pressing the accelerator.

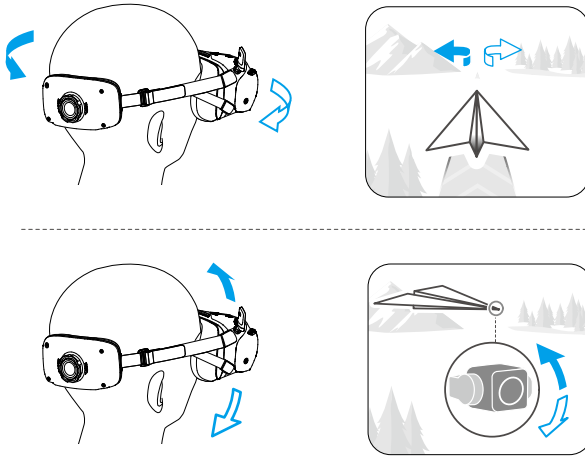

Easy ACRO

Use the motion controller to perform Easy ACRO actions including front flip, backflip, roll, and 180° drift.

- ⚠ • Obstacle avoidance is disabled when Easy ACRO is enabled. Obstacle avoidance automatically resumes once Easy ACRO is disabled. Pay attention to surroundings and make sure there are no obstacles nearby before performing Easy ACRO actions.
- Easy ACRO is unavailable in the following situations:
 - ♦ The aircraft is taking off, hovering, landing, or returning to home;
 - ♦ The aircraft is in Sport mode;
 - ♦ The aircraft battery level is lower than 35%;
 - ♦ The altitude of the aircraft is less than 1.5 m;
 - ♦ Wind speed is above 4 m/s;
 - ♦ The positioning performance is poor (GNSS and vision system are not available);
 - ♦ The aircraft is in a buffer zone of a Restricted Zone or an Altitude Zone, or is approaching the Max Flight Distance.
- Use Easy ACRO with caution in the following situations:
 - ♦ When the attitude angle of the aircraft increases (such as when making turns, accelerating or decelerating quickly, or when the wind speed is above

2 m/s), the aircraft altitude will also need to be increased. Otherwise Easy ACRO may not be available.

- ◆ When the attitude angle of the aircraft is not stable (such as when making turns, accelerating or decelerating quickly, when the wind speed is above 2 m/s, or when triggering Easy ACRO continuously), the aircraft may drift sideways and its altitude may be not stable after performing Easy ACRO actions. Pay attention to the surrounding environment and aircraft altitude to avoid collisions.



• Easy ACRO cannot be enabled in the following situations:

- ◆ When recording video;
- ◆ When Head Tracking is enabled;
- ◆ When used with DJI FPV Remote Controller 3.

1. Open the shortcut menu and select **Easy ACRO**. The aircraft will be in Easy ACRO mode. View the selected action on the left side of liveview in the goggles.

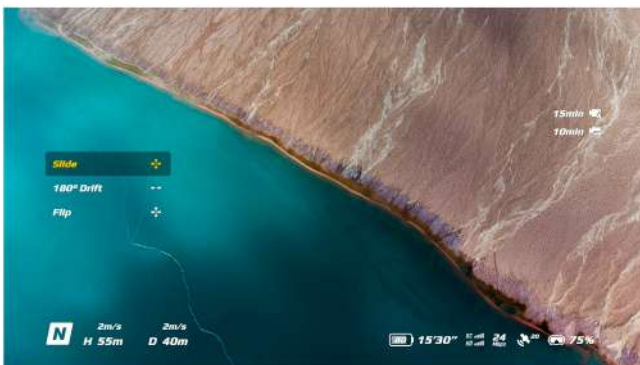
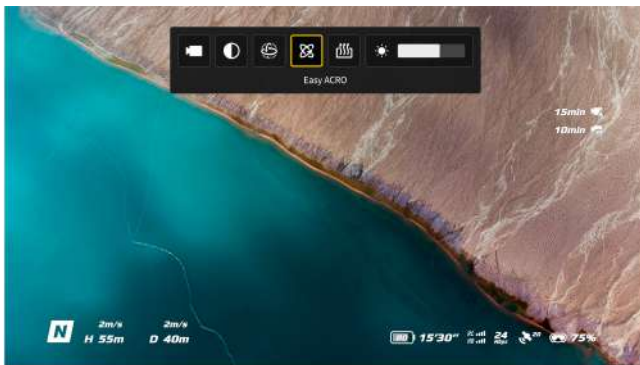

2. Use the dial on the motion controller to switch between Easy ACRO actions.

- When Easy ACRO is enabled, move the joystick to perform different Easy ACRO actions as shown below.

Slide

Push the joystick up or down to make the aircraft ascend or descend.

Push the joystick left or right to make the aircraft move left or right horizontally.

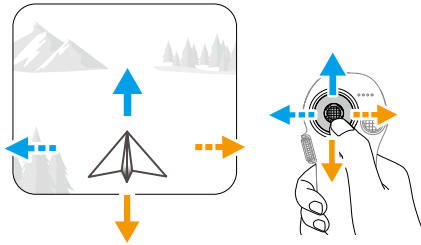

180° Drift

Push the joystick left or right to make the aircraft 180° drift left or right.

The aircraft will not respond when pushing the joystick up or down in this action mode.

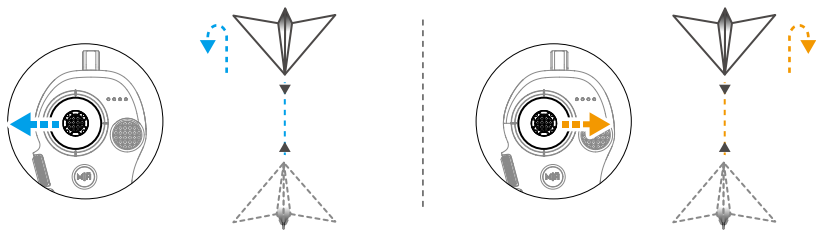

Flip

Push the joystick up or down to make the aircraft perform a front flip or backflip.

Push the joystick left or right to make the aircraft do one roll to the left or right.

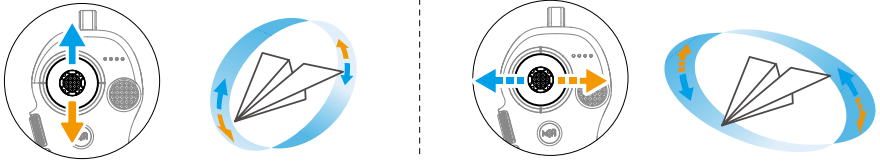

3.5 Video Recording Suggestions and Tips

1. The pre-flight checklist is designed to help the user fly safely and shoot videos during flight. Go through the full pre-flight checklist before each flight.
2. If using the remote controller, it is recommended to take photos or record videos when flying in Normal or Cine mode.
3. DO NOT fly in bad weather such as on rainy or windy days.
4. Choose the camera settings that best suit your needs.
5. Perform flight tests to establish flight routes and preview scenes.
6. Make sure to control DJI Neo 2 gently to ensure a smooth and stable flight.
7. Clear any foreign objects from the air intake on both sides of DJI Neo 2 after flight to prevent a blockage.

Aircraft

4 Aircraft

4.1 Flight Modes

When using Palm Control and Mobile App Control, DJI Neo 2 does not support the switching of flight modes.

When using the DJI RC-N3 Remote Controller, flight modes can be switched between Normal, Sport, and Cine using the flight mode switch on the remote controller.

When using the motion controller, flight modes can be switched between Normal and Sport using the mode button on the motion controller.

When using the FPV remote controller, flight modes can be switched between Normal and Sport using the flight mode switch on the remote controller.

Normal Mode: The aircraft can hover precisely and fly stably and is suitable for most flight scenarios.

Sport Mode: The maximum horizontal flight speed of the aircraft will increase in Sport mode. Note that obstacle avoidance is disabled in Sport mode.

Cine Mode: Cine mode is based on Normal mode with a limited flight speed, making the aircraft more stable during recording.

The aircraft automatically changes to Attitude (ATTI) mode when the vision system is unavailable or disabled and the GNSS signal is weak or the compass experiences interference. In ATTI mode, the aircraft may be more easily affected by its surroundings. Environmental factors such as wind can result in horizontal drift of the aircraft, which may present hazards, especially when flying in confined spaces. The aircraft will not be able to hover or brake automatically, therefore the pilot should land the aircraft as soon as possible to avoid accidents.









 • The flight modes are only effective for manual flight using a remote control device.

-
-  • The maximum flight speed and braking distance of the aircraft significantly increases in Sport mode. A minimum braking distance of 20 m is required in windless conditions.
- A minimum braking distance of 5 m is required in windless conditions while the aircraft is ascending and descending in Sport mode or Normal mode.
 - The responsiveness of the aircraft significantly increases in Sport mode, which means a small control stick movement on the remote control device translates into the aircraft moving a large distance. Make sure to maintain adequate maneuvering space during flight.
 - You may experience shaking in videos recorded in Sport mode.
-

4.2 Aircraft Status Indicator



Aircraft Status Indicators Descriptions



| Normal | | |
|--|----------------------|---|
|  | Blinks blue slowly | Searching for the palm/Palm landing in progress |
|  × 2 | Blinks blue twice | Both hands confirmed during Gesture Control |
|  — | Solid blue | Gesture Control |
|  | Pulses green | Manual Control |
|  | Blinks white | Photo countdown |
|  — | Solid white | Recording video |
| Warning States | | |
|  | Blinks red quickly | Critically low battery/GNSS and visual disabled (Attitude mode enabled) |
|  — | Solid red | Tracking subject lost / Takeoff is disabled(e.g., low battery) ^[1] |
|  | Blinks yellow slowly | Automatically initiates RTH when Smart Snaps exits unexpectedly |

[1] If the aircraft cannot take off while the status indicator is solid red, view the warning prompt in DJI Fly.

4.3 Return to Home

Carefully read the contents of this section to ensure you are familiar with the behavior of the aircraft in Return-to-Home (RTH).

When controlling the aircraft with a remote controller or the mobile app, the RTH function is available. The RTH function will automatically fly the aircraft back to the last recorded Home Point. RTH can be triggered in three ways: the user actively triggers RTH, the aircraft has low battery, or the remote control signal or video transmission signal has been lost (Failsafe RTH is triggered). If the aircraft records the Home Point successfully and the positioning system is functioning normally, when the RTH function is triggered, the aircraft will automatically fly back and land at the Home Point.

 **Home Point:** The Home Point will be recorded at takeoff as long as the aircraft has a strong GNSS signal  26. After the Home Point is recorded, DJI Fly will issue a voice prompt. The Home Point is set to the takeoff location by default. During flight, the Home Point updates depend on the control method.

- When controlling the aircraft with a remote controller, the Home Point can be manually updated in *** > **Safety** page in DJI Fly if necessary during a flight (e.g., if your position has changed).
- For Mobile App Control, the Home Point is dynamically updated based on the subject's location when using Follow or other subject-tracking functions.

During RTH, the AR RTH route will be displayed on the camera view, helping you to view the return path and ensure flight safety. The camera view also displays the AR Home Point. When the aircraft reaches the area above the Home Point, the gimbal camera will automatically flip downwards. The AR aircraft shadow will appear in the camera view when the aircraft is approaching the ground, enabling you to control the aircraft to land more accurately in your preferred location.

The AR Home Point, AR RTH route, and AR aircraft shadow will be displayed in the camera view by default. The display can be changed in *** > **Safety** > **AR Settings**.

-  • The AR RTH route is only used for reference, and may deviate from the actual flight route in different scenarios. Always pay attention to the liveview on the screen during RTH. Fly with caution.
- During RTH, the aircraft will automatically adjust the gimbal tilt to point the camera toward the RTH route by default. Using the gimbal dial to adjust the camera orientation or pressing the customizable buttons on the remote controller to recenter the camera will stop the aircraft from automatically adjusting the gimbal tilt, which may prevent the AR RTH route from being viewed.

Notice

-  • The aircraft may not be able to return to the Home Point as normal if the positioning system is functioning abnormally. During Failsafe RTH, the aircraft may enter ATTI mode and land automatically if the positioning system is functioning abnormally.
- When using Mobile App Control, the aircraft will only perform a landing and cannot perform RTH if there is no GNSS signal.
 - When there is no GNSS signal, DO NOT fly over water surfaces, buildings with glass surface, or in scenarios where the altitude above the ground is greater

than 10 m. If the positioning system is functioning abnormally, the aircraft will enter ATTI mode.

- It is important to set a suitable RTH altitude before each flight. Launch DJI Fly and set the RTH altitude.
- The aircraft cannot sense obstacles during RTH if the environment conditions are not suitable for the sensing system.
- GEO zones may affect the RTH. Avoid flying near GEO zones.
- The aircraft may not be able to return to a Home Point if the wind speed is too high. Fly with caution.
- Pay extra attention to small or fine objects (such as tree branches or power lines) or transparent objects (such as water or glass) during RTH. Exit RTH and control the aircraft manually in an emergency.
- Set Advanced RTH as **Preset** if there are power lines or transmission towers that the aircraft cannot bypass on the RTH path and make sure the RTH Altitude is set higher than all obstacles.
- The aircraft will brake and return to home according to the latest settings if the **Advanced RTH** settings in DJI Fly are changed during RTH.
- If the max altitude is adjusted below the current altitude during RTH, the aircraft will descend to the max altitude first and then continue returning to home.
- The RTH Altitude cannot be changed during RTH.
- If there is a large difference between the current altitude and the RTH altitude, the amount of battery power used cannot be calculated accurately due to wind speed differences at different altitudes. Pay extra attention to the battery power prompts and warning prompts in DJI Fly.
- When the remote controller signal is normal during Advanced RTH, the pitch stick can be used to control the flight speed, but the orientation and altitude cannot be controlled and the aircraft cannot be controlled to fly to the left or right. Constantly pushing the pitch stick to accelerate will increase the battery power consumption speed. The aircraft cannot bypass obstacles if the flight speed exceeds the effective sensing speed. The aircraft will brake and hover in place and exit RTH if the pitch stick is pushed all the way down. The aircraft can be controlled after the pitch stick is released.
- If the aircraft reaches the altitude limit of the aircraft current location or of the Home Point while it is ascending during Preset RTH, the aircraft stops ascending and returns to the Home Point at the current altitude. Pay attention to flight safety during RTH.

- If the Home Point is within the Altitude Zone but the aircraft is not in the Altitude Zone, when the aircraft reaches the Altitude Zone it will descend below the altitude limit, which may be lower than the set RTH altitude. Fly with caution.
- The aircraft will exit RTH if the surrounding environment is too complex to complete RTH, even if the sensing system is working properly.
- RTH cannot be triggered during auto landing.



Advanced RTH

When Advanced RTH is triggered, the aircraft will automatically plan the best RTH path, which will be displayed in DJI Fly and will be adjusted according to the environment. During RTH, the aircraft will adjust the flight speed automatically according to environmental factors such as the wind speed, wind direction, and obstacles.

If the control signal between the remote controller and the aircraft is good, exit RTH by tapping  in DJI Fly or by pressing the RTH button on the remote controller. After exiting RTH, you will regain control of the aircraft.

Trigger Method

The user actively triggers RTH

- **Palm Control:** When the aircraft is within 5 m of the subject, extend your palm, the aircraft will automatically return and land on your hand once confirming your palm.
- **Mobile App Control:** During flight, tap  on the left side of the camera view in DJI Fly. In the pop-up window, press and hold the RTH icon to trigger RTH.
- **Using the remote controller:** During flight, you can trigger RTH by pressing and holding the RTH button on the remote controller, or tapping  on the left side of the camera view in DJI Fly and then pressing and holding the RTH icon.

If the remote controller signal is lost during RTH, the aircraft will continue the RTH procedure regardless of the preset Signal Lost Action.

- **Using the motion controller:** Press and hold the mode button on the motion controller to initiate RTH. The aircraft will fly back to the last updated Home Point. During RTH, press the lock button once to cancel RTH. After exiting RTH, users will regain control of the aircraft.

Aircraft low battery

During flight, if the battery level is low and only sufficient to fly to the Home Point, a warning prompt will appear in DJI Fly. If you tap to confirm RTH or do not take action before the countdown ends, the aircraft will automatically initiate low battery RTH.

If you cancel the low battery RTH prompt and continue flying the aircraft, the aircraft will land automatically when the current battery level can only support the aircraft long enough to descend from its current altitude.

The remote control devices can be used to control the horizontal movement of the aircraft during the landing process. Fly the aircraft to a suitable place for landing as soon as possible.

-
- ⚠ • When the Intelligent Flight Battery battery level is too low and there is not enough power to return home, land the aircraft as soon as possible. Delayed action will initiate progressive thrust decay, potentially escalating to uncontrolled descent upon total depletion. This may cause aircraft destruction, third-party property damage, or personal injury.
 - DO NOT keep pushing the throttle stick upward during auto landing. Otherwise, the aircraft will experience progressive thrust decay and even crash after the battery power is completely depleted.
-

Loss of remote controller signal

When the remote controller signal is lost for more than 6 seconds, the aircraft will automatically initiate Failsafe RTH if the Signal Lost Action is set to RTH. The action can also be set to Hover or Landing.

When the lighting and environment conditions are suitable for the vision system, the aircraft will start RTH using Advanced RTH according to the RTH settings. The aircraft will remain in RTH even if the remote controller signal is restored. DJI Fly will update the RTH path accordingly.

When the lighting and environment conditions are unsuitable for the vision system, the aircraft will brake and hover, then enter Original Route RTH.

- If the RTH distance (the horizontal distance between the aircraft and the Home Point) is farther than 50 m, the aircraft adjusts its orientation and flies backward for 50 m on its original flight route before entering Preset RTH.
- If the RTH distance is farther than 5 m but less than 50 m, the aircraft adjusts its orientation and flies straight horizontally back to the home point at the current altitude.
- The aircraft lands immediately if the RTH distance is less than 5 m.

RTH Procedure

After Advanced RTH is triggered, the aircraft brakes and hovers in place.

- **When the environment or lighting conditions are suitable for the vision system:**

The aircraft will adjust its orientation to the Home Point, plan the best path according to the RTH settings and then return to the Home Point.

- **When the environment or lighting conditions are not suitable for the vision system:**
 - ♦ If the RTH distance is further than 5 meters, the aircraft will return to home according to the **Preset**.
 - ♦ The aircraft lands immediately if the RTH distance is less than 5 m.*
- * When using Mobile App Control, the aircraft lands immediately if the RTH distance is less than 2 m.

RTH Settings

- ⚠ • When using Mobile App Control, RTH route settings are not supported, and the aircraft always returns along the optimal path.

If the lighting is sufficient and the environment is suitable for the vision system, the aircraft will automatically plan the optimal RTH path and adjust the altitude according to environmental factors, such as obstacles and transmission signals.

When the vision system is not functioning properly:

- ♦ If a subject has already been tracked: The Home Point will be dynamically updated to the subject's location, and the RTH altitude will be set to a lower one directly above the subject.
- ♦ If a subject has not been tracked: The aircraft will ascend to a preset safe altitude and return to home, thereby avoiding most common obstacles.

RTH settings are available for Advanced RTH. Go to the camera view in DJI Fly or the goggles (if in use), tap *** > **Safety**, and scroll to **Return to Home (RTH)**.

- **Optimal:**



- ♦ If the lighting is sufficient and the environment is suitable for the vision system, the aircraft will automatically plan the optimal RTH path and adjust the altitude

according to environmental factors, such as obstacles and transmission signals, regardless of the RTH Altitude setting. The optimal RTH path means the aircraft will travel the shortest distance possible to reduce the amount of battery power used and to increase flight time.

- If the lighting is insufficient or the environment is not suitable for the vision system, the aircraft will perform Preset RTH based on the RTH Altitude setting.
- **Preset:**



| RTH Distance/Altitude | | Suitable Lighting and Environment Conditions | Unsuitable Lighting and Environment Conditions |
|-------------------------------|---------------------------------|---|--|
| RTH distance > 50 m | Current altitude < RTH altitude | The aircraft will plan the RTH path, fly to an open area while bypassing obstacles, ascend to the RTH Altitude, and return to home using the best path. | The aircraft will ascend to the RTH altitude, and fly to the Home Point in a straight line at the RTH altitude. ^[1] |
| | Current altitude ≥ RTH altitude | The aircraft will return to home using the best path at the current altitude. | The aircraft will fly to the Home Point in a straight line at the current altitude. ^[1] |
| RTH distance is within 5-50 m | | | The aircraft will fly to the Home Point in a straight line at the current altitude. ^[2] |

[1] If the forward-facing LiDAR detects an obstacle ahead, the aircraft will ascend to avoid the obstacle. It will stop climbing once the path ahead is clear and then continue to RTH. If the obstacle height exceeds the altitude limit, the aircraft will brake and hover, and the user will need to take control.

[2] The aircraft will brake and hover, and the user will need to take control.

When the aircraft is approaching the Home Point, if the current altitude is higher than the RTH altitude, the aircraft will intelligently decide whether to descend while flying forward according to the surrounding environment, lighting, the set RTH altitude, and

the current altitude. When the aircraft reaches the area above the Home Point, the current altitude of the aircraft will not be lower than the set RTH altitude.

The RTH plans for different environments, RTH trigger methods, and RTH settings are as follows:

| RTH Trigger Method | Suitable Lighting and Environment Conditions (The aircraft can bypass obstacles and GEO zones) | Unsuitable Lighting and Environment Conditions |
|----------------------------------|---|--|
| The user actively triggers RTH | The aircraft will execute RTH based on the RTH setting: <ul style="list-style-type: none"> • Optimal • Preset | Preset (The aircraft can ascend to bypass obstacles and GEO zones) |
| Aircraft low battery | | Original route RTH, Preset RTH will be executed when the signal is restored |
| Loss of remote controller signal | | (The aircraft can bypass GEO zones and will brake and hover if there is obstacle) |

Landing Protection

During RTH, landing protection activates once the aircraft begins to land.

The specific performance of the aircraft is as follows:

- If the ground is determined suitable for landing, DJI Neo 2 will land directly.
- If the ground is determined unsuitable for landing, DJI Neo 2 will hover and wait for pilot confirmation. You can perform palm landing or land DJI Neo 2 manually.
- If DJI Neo 2 fails to determine whether the ground environment is suitable for landing, DJI Fly or the goggles will display a landing prompt when DJI Neo 2 descends to 0.3 m from the ground. Confirm the landing prompt and DJI Neo 2 will land. You can also perform palm landing or land DJI Neo 2 manually.



- Landing Protection only assists in determining the landing environment. Pay attention to the surrounding environment during landing to ensure safety.
- In the following situations, Landing Protection may be unavailable and DJI Neo 2 may land directly on unsuitable ground:
 - Flying over monochrome, reflective, or low-light surfaces, a large area of surfaces without clear texture, or surfaces with dynamic texture, such as smooth ceramic tiles, garage floors with insufficient light, and grass blowing in the wind.

- Flying over obstacles without clear texture, such as large rocks, or reflective or monochrome surfaces, such as raised tiles.
 - Flying over small or fine obstacles, such as power lines and tree branches.
 - Flying over surfaces that resemble flat ground, such as trimmed and flat shrubs, flat tree tops, and hemispherical ground.
 - In the following situations, Landing Protection may be triggered by mistake and DJI Neo 2 is unable to land. You can perform palm landing or land DJI Neo 2 manually.
 - Flying over surfaces that the vision system may confuse for water, such as wet ground and areas with puddles.
 - Flying over flat surfaces, but there are surfaces with clear texture (oblique surfaces or stairs) nearby.
-

4.4 Sensing System

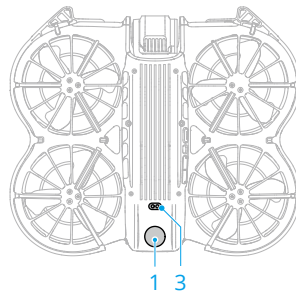
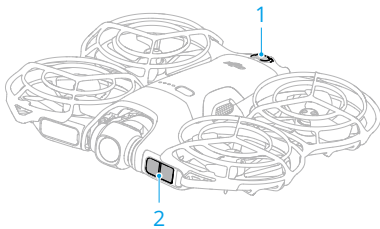

1. Omnidirectional Monocular Vision System
2. Forward-facing LiDAR*
3. Downward Infrared Sensing System

* The forward-facing LiDAR meet the human eye safety requirements for Class 1 laser products.

The forward-facing LiDAR can detect obstacles ahead. The omnidirectional monocular vision system works best with adequate lighting and clearly marked or textured obstacles. The omnidirectional monocular vision system will activate automatically when the aircraft is in Normal or Cine mode and obstacle avoidance action is set to **Bypass** or **Brake** in DJI Fly. The positioning function is applicable when GNSS signals are unavailable or weak.

-
-  When Vision Positioning and Obstacle Avoidance is disabled, the aircraft relies only on GNSS to hover, omnidirectional obstacle avoidance is unavailable, and the aircraft will not automatically decelerate during descent close to the ground.

Extra caution is required when Vision Positioning and Obstacle Avoidance is disabled.

- Disabling Vision Positioning and Obstacle Avoidance takes effect only when flying manually, and will not take effect when using RTH, auto landing, or using Intelligent Flight Modes.
- Vision Positioning and Obstacle Avoidance can be temporarily disabled in clouds and fog or when an obstacle is detected when landing. Keep Vision Positioning and Obstacle Avoidance enabled in regular flight scenarios. Vision Positioning and Obstacle Avoidance is enabled by default after restarting the aircraft.

Notice

- ⚠ • Pay attention to the flight environment. The sensing system only works in certain scenarios and cannot replace human control and judgment. During a flight, always pay attention to the surrounding environment and the warnings in DJI Fly, and be responsible for and maintain control of the aircraft at all times.
- If there is no GNSS available, the downward vision system will assist with aircraft positioning, and works best when the aircraft is at an altitude from 0.5 m to 10 m. Extra caution is required if the altitude of the aircraft is above 30 m as the vision positioning performance may be affected.
- The downward vision system may not work properly when the aircraft is flying near water. Therefore, the aircraft may not be able to actively avoid water below it when landing. It is recommended to maintain flight control at all times, make reasonable judgments based on the surrounding environment, and avoid over-relying on the downward vision system.
- The vision system cannot accurately identify large structures with frames and cables, such as tower cranes, high-voltage transmission towers, high-voltage transmission lines, cable-stayed bridges, and suspension bridges.
- The vision system cannot work properly near surfaces without clear pattern variations or where the lighting is too weak or too strong. The vision system cannot work properly in the following situations:
 - ◆ Flying near monochrome surfaces (e.g., pure black, white, red, or green).
 - ◆ Flying near highly reflective surfaces.
 - ◆ Flying near water or transparent surfaces.
 - ◆ Flying near moving surfaces or objects.
 - ◆ Flying in an area with frequent and drastic lighting changes.
 - ◆ Flying near extremely dark (<1 lux) or bright (>100,000 lux) surfaces.

- Flying near surfaces that strongly reflect or absorb infrared waves (e.g., mirrors, glass, road signs, and asphalt pavements).
- Flying near surfaces without clear patterns or textures.
- Flying near surfaces with repeating identical patterns or textures (e.g., tiles with the same design).
- Flying near obstacles with small surface areas (e.g., fences, tree branches, and power lines).
- Flying near small pole-like objects (e.g., utility poles, streetlight poles).
- Flying near moving subjects (e.g., people walking or vehicles).
- Keep the sensors clean at all times. DO NOT scratch or tamper with the sensors. DO NOT use the aircraft in dusty or humid environments.
- The vision system cameras may need to be calibrated after being stored for an extended period. A prompt will appear in DJI Fly and calibration will be performed automatically.
- DO NOT fly when it is rainy, smoggy, or the visibility is lower than 100 m.
- DO NOT obstruct the sensing system.
- DO NOT take off rapidly towards an obstacle to avoid the risk of the sensing system failing to respond in time, which could lead to a collision.
- Check the following each time before takeoff:
 - Make sure there are no stickers or any other obstructions over the glass of the sensing system.
 - Use a soft cloth if there is any dirt, dust, or water on the glass of the sensing system. DO NOT use any cleaning product that contains alcohol.
 - Contact DJI Support if there is any damage to the lenses of the sensing system.
- The forward-facing LiDAR cannot detect obstacles with a reflectivity of less than 10% or reflective objects such as glass.

4.5 Advanced Pilot Assistance Systems

The Advanced Pilot Assistance Systems (APAS) feature is available in Normal mode and Cine mode. When APAS is enabled, the aircraft will continue to respond to your commands and plan its path according to both control stick inputs and the flight environment. APAS makes it easier to avoid obstacles, obtain smoother footage, and give a better flying experience.

When APAS is enabled, the aircraft can be stopped by pressing the Flight Pause button on the remote controller. The aircraft brakes and hovers for three seconds and awaits further pilot commands.

To enable APAS, open DJI Fly, go to **Safety > Manual Obstacle Avoidance**, and select **Bypass**. Set **Bypassing Options** to **Normal** or **Nifty**. In **Nifty** mode, the aircraft can fly faster, smoother, and closer to obstacles obtaining better footage while bypassing obstacles. However, the risk of crashing into obstacles will increase. Fly with caution.

Nifty mode cannot work normally in the following situations:

- When aircraft orientation changes rapidly flying near obstacles.
- When flying through narrow obstacles such as canopies or bushes at high speed.
- When flying near obstacles that are too small to detect.

Notice



- Make sure to use APAS when the vision system is available. Make sure there are no people, animals, objects with small surface areas (e.g., tree branches), or transparent objects (e.g., glass or water) along the desired flight path.
- Make sure to use APAS when the downward vision system is available or the GNSS signal is strong. APAS may not function properly when the aircraft is flying over water.
- Be extra cautious when flying in extremely dark (<5 lux) or bright (>100,000 lux) environments.
- Pay attention to DJI Fly and make sure APAS is working normally.
- APAS may not function properly when the aircraft is flying near flight limits or in a GEO zone.
- When the lighting becomes insufficient and the vision system is partially unavailable, the aircraft will switch from bypassing obstacles to braking and hovering. You need to center the control stick and then to continue controlling the aircraft.

Landing Protection

If obstacle avoidance action is set to **Bypass** or **Brake**, Landing Protection will be activated when you push the throttle stick down to land the aircraft. Landing Protection is enabled once the aircraft begins to land.

- If the ground is determined to be suitable for landing, the aircraft will land directly.

- If the ground is determined to be unsuitable for landing, the aircraft will hover when the aircraft descends to a certain height above ground. Push down on the throttle stick for at least five seconds, and the aircraft will land without obstacle avoidance.

4.6 Propellers and Propeller Guards

DJI Neo 2 comes with detachable propeller guards, which reduce damage to the propellers caused by collisions. It is required to remove the propeller guards on top of DJI Neo 2 before removing or installing the propellers.

Removing and Installing



Click the link or scan the QR code to watch the tutorial videos.



<https://www.dji.com/neo-2/video>

Propeller Guard

Make sure that DJI Neo 2 is powered off. Remove the propeller guards by following the steps below.

1. Place the aircraft upside down.

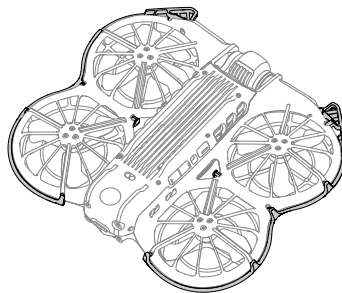

2. Press the center of the guard to release the buckle to open it.

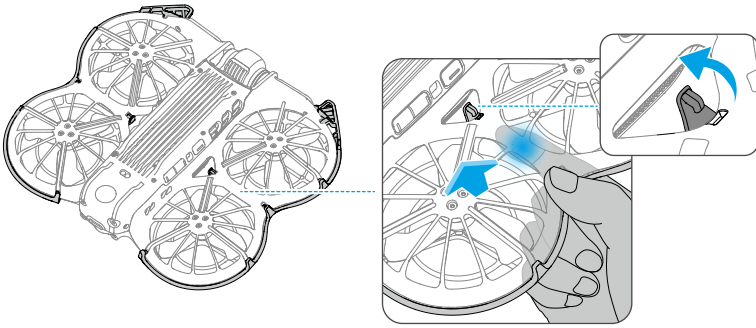

3. Lift the front protrusion of the guard to release the buckle.

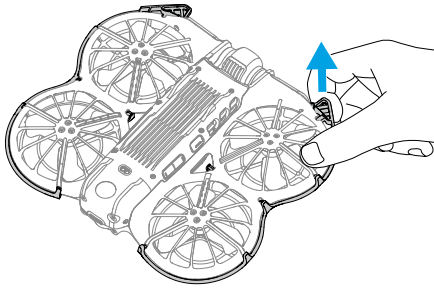

4. Operate along the edge to release the remaining buckles.

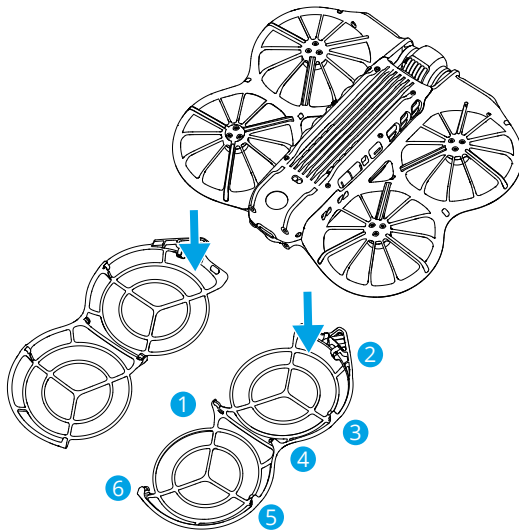

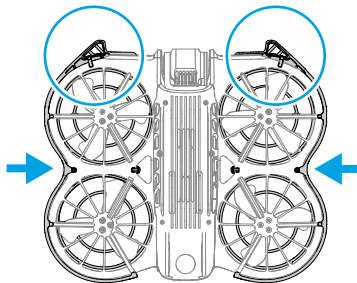

Install the propeller guards by following the steps below.

1. Check the propeller guard and ensure the front protrusion is aligned with the front of the aircraft.

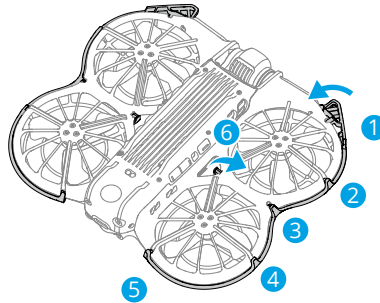

2. Secure all remaining buckles onto the aircraft body to ensure firm installation.



-
-  Make sure that the propeller guard is properly installed and buckles are securely fastened. Otherwise, the forward-facing LiDAR may be obstructed, leading to abnormal obstacle avoidance performance.
-

Propellers

Use the screwdriver in the box of DJI Neo 2 to install and remove the propellers. It is required to remove the propeller guards before installing and removing the propellers.

1. Use the screwdriver to remove the propellers from the motors.

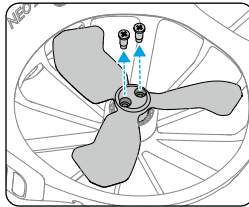

2. Install the marked propellers onto the motors of the marked frame arms and the unmarked propellers onto the motors of the unmarked frame arms. Use the screws provided in the packaging of the propellers to secure the propellers. Make sure to tighten the screws.

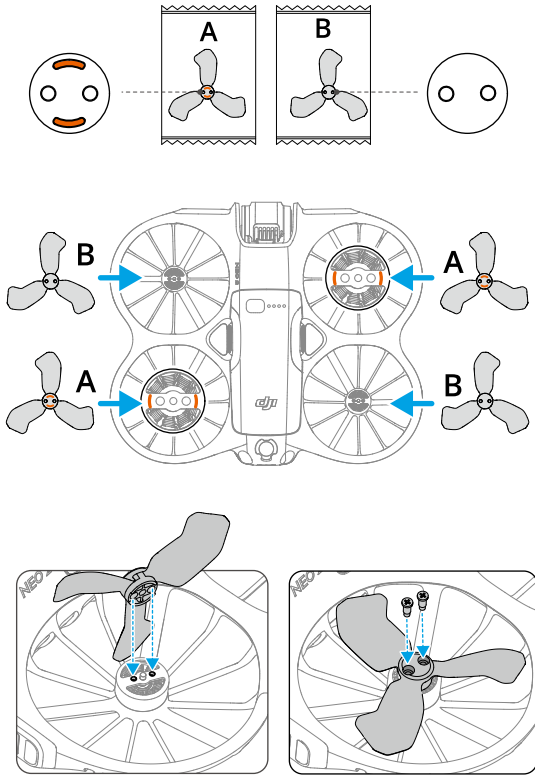

3. Reinstall the propeller guards after installing the propellers.

Notice

- ⚠ • DO NOT install or remove the propeller guard by force to avoid damage.
- DO NOT press the propeller guard struts located underneath the aircraft to avoid damage.
- Make sure to only use the screwdriver from the aircraft package for mounting propellers. Using other screwdrivers may damage the screws.
- Make sure to keep the screws vertical while tightening them. The screws should not be at a tilted angle to the mounting surface. After installation is complete, check whether the screws are flush and rotate the propellers to check for any abnormal resistance.

- Check to make sure the screws on the propellers are tightened after every 30 hours of flying time (approx. 60 flights).
- The screwdriver is only for mounting the propellers. DO NOT use the screwdriver to disassemble the aircraft.
- If a propeller is broken, remove the propellers and screws on the corresponding motor and discard them.
- The propeller blades are sharp. Handle with care to avoid personal injury or propeller deformation.
- Make sure that the propellers and motors are installed securely before each flight.
- Only use official DJI propellers. DO NOT mix propeller types.
- Propellers are consumable components. Purchase additional propellers if necessary.
- Make sure that all propellers are in good condition before each flight. DO NOT use aged, chipped, or broken propellers. Clean the propellers with a soft, dry cloth if there is any foreign matter attached.
- To avoid injury, stay away from rotating propellers or motors.
- To avoid damaging the propellers, place the aircraft correctly during transportation or storage. DO NOT squeeze or bend the propellers. If propellers are damaged, the flight performance may be affected.
- Make sure the motors are mounted securely and rotating smoothly. If the motor overloads or stalls during flight, land immediately.
- DO NOT attempt to modify the structure of the motors.
- DO NOT touch or let hands or body parts come in contact with the motors after flight, as they may be hot.
- DO NOT block any of the ventilation holes on the motors or the body of the aircraft.
- Make sure the ESCs sound normal when powered on.

4.7 Intelligent Flight Battery

Notice

- ⚠ • Read and strictly follow the instructions in this manual, in the *Safety Guidelines* and on the battery stickers before using the battery. You shall take full responsibility for all operations and usage.

1. DO NOT charge an Intelligent Flight Battery immediately after flight as it may be too hot. Wait for the battery to cool down to the allowable charging temperature before charging again.
2. To prevent damage, the battery only charges when the battery temperature is between 5° and 40° C (41° and 104° F). The ideal charging temperature is from 22° to 28° C (71.6° to 82.4° F). Charging at the ideal temperature range can prolong battery life. Charging stops automatically if the temperature of the battery cells exceed 55° C (131° F) during charging.
3. Low-Temperature Notice:
 - Batteries cannot be used in extremely low-temperature environments of lower than -10° C (14° F).
 - Battery capacity is significantly reduced when flying at low temperatures from -10° to 5° C (14° to 41° F). Make sure to fully charge the battery before takeoff. Hover the aircraft in place for a while to warm up the battery after takeoff.
 - It is recommended to warm up the battery to at least 10° C (50° F) before takeoff when flying in low-temperature environments. The ideal temperature to warm up the battery is above 20° C (68° F).
 - The reduced battery capacity in low-temperature environments reduces the wind speed resistance performance of the aircraft. Fly with caution.
 - Take extra caution when flying at a high elevation with a low temperature.
4. A fully charged battery will automatically discharge when it is idle for a period of time. Note that it is normal for the battery to emit heat during the discharging process.
5. Fully charge the battery at least once every three months to maintain battery health. If the battery is not used for an extended period, battery performance may be affected or may even cause permanent battery damage. If a battery has not been charged or discharged for three months or more, the battery will no longer be covered by the warranty.
6. For safety purposes, keep the batteries at a low power level in transit. Before transportation, it is recommended to discharge the batteries to 30% or lower.

Installing/Removing the Battery

Installation

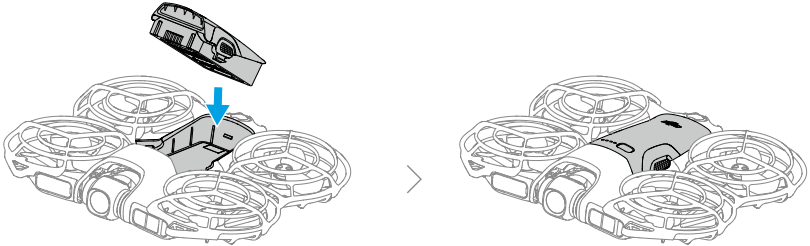

Removal

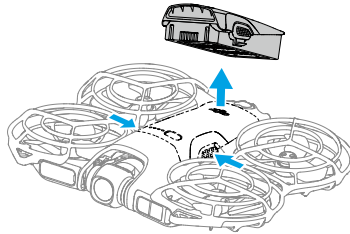

-
- ⚠ • DO NOT insert or remove the battery while the aircraft is powered on.
 - Make sure the battery is mounted securely with a clicking sound. DO NOT launch the aircraft when the battery is not securely mounted, as this may cause poor contact between the battery and the aircraft and present hazards.
-

Using the Battery



Checking the Battery Level

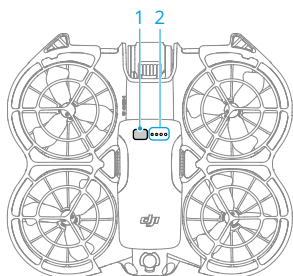







Press the power button once to check the current battery level.



1. Power Button
2. Battery Level LEDs

The battery level LEDs display the power level of the battery during charging and discharging. The statuses of the LEDs are defined below:

-  LED is on
-  LED is flashing
-  LED is off

| Blinking Pattern | Battery Level |
|---|---------------|
|  | 88-100% |
|  | 76-87% |
|  | 63-75% |
|  | 51-62% |
|  | 38-50% |
|  | 26-37% |
|  | 13-25% |
|  | 0-12% |

Powering On/Off

Press, then press and hold the power button to power the aircraft on or off. The battery level LEDs display the battery level when the aircraft is powered on. The battery level LEDs turn off when the aircraft is powered off.

Charging the Battery

Fully charge the battery before each use. It is recommended to use the charging devices provided by DJI or other chargers that support the USB PD fast charging protocol.

Using a Charger

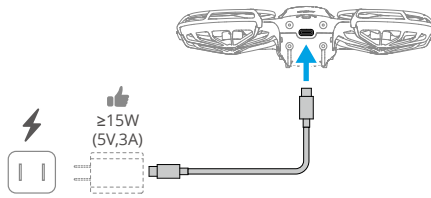

-
- ⚠ • The battery cannot be charged if the aircraft is powered on.
-

The table below shows the battery level during charging.

| Blinking Pattern | Battery Level |
|------------------|---------------|
| | 0-50% |
| | 51-75% |
| | 76-99% |
| | 100% |

-
- 💡 • The blinking frequency of the battery level LEDs differs depending on the USB charger used. If the charging speed is fast, the battery level LEDs will blink quickly.
 - Four LEDs blinking simultaneously indicates the battery is damaged.
-

Using the Charging Hub



It is recommended to click the link below or scan the QR code to watch the tutorial video.



<https://www.dji.com/neo-2/video>

-
- ⚠ • The environmental temperature affects the charging speed. Charging is faster in a well-ventilated environment at 25° C (77° F).

- The charging hub is only compatible with specific model of the Intelligent Flight Battery. DO NOT use the charging hub with other battery models.
- Place the charging hub on a flat and stable surface when in use. Make sure the device is properly insulated to prevent fire hazards.
- DO NOT touch the metal terminals on the battery ports.
- Clean the metal terminals with a clean, dry cloth if there is any noticeable buildup.

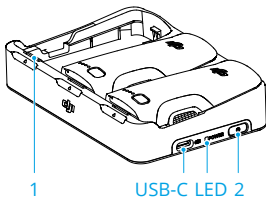

1. Battery Port
2. Function Button

How to Charge

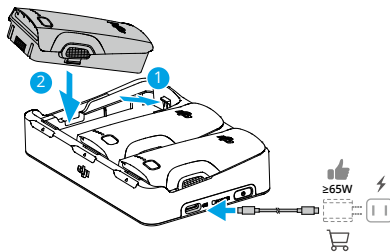

Insert the batteries into the battery ports of the charging hub until they click into place. Connect the charging hub to a power outlet using a USB charger.

The charging method varies depending on the power of the charger. Refer to the table below for details.

The battery can be stored in the charging hub after charging.

| | |
|------------------------------------|--|
| Charger Power ≤ 30 W | Charges in sequence from highest to lowest battery level. |
| 30 W < Charger Power ≤ 45 W | Charges two batteries simultaneously: First charges the battery with a lower battery level to the same level as the highest one and then charges the two batteries simultaneously. |

Charger Power > 45 W

Charges three batteries simultaneously: First charges the two batteries with a lower battery level to the same level as the highest one and then charges the batteries simultaneously.

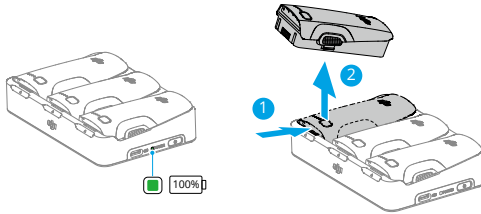

Remove the corresponding battery from the charging hub as shown.

Using Charging Hub as a Power Bank

1. Insert one or more batteries into the charging hub. Connect an external device via the USB-C port, such as a mobile phone or remote controller.
2. Press the function button, and the status LED of the charging hub turns solid green. The battery with the lowest power level will be discharged first, followed by the remaining batteries to be discharged sequentially. To stop charging the external device, disconnect the external device from the charging hub.









- If the remaining charge of a battery is lower than 5%, the battery cannot charge the external device.
- To switch to charging Intelligent Flight Batteries, reconnect the USB-C cable.

Status LED Descriptions

| Blinking Pattern | Description |
|------------------|---|
| Solid yellow | The charging hub is idle |
| Pulses green | Charging the battery |
| Solid green | All batteries fully charged or supplying power to external devices |
| Blinks yellow | Temperature of the batteries is too low or too high (no further operation needed) |
| Solid red | Power supply error or battery error (remove and reinsert the batteries or unplug and plug in the charger) |

Battery Protection Mechanisms

The battery level LEDs can display battery protection notifications triggered by abnormal charging conditions.

| LEDs | Blinking Pattern | Status |
|---|------------------------------------|----------------------------------|
|  | LED2 blinks twice per second | Overcurrent detected |
|  | LED2 blinks three times per second | Short circuit detected |
|  | LED3 blinks twice per second | Overcharge detected |
|  | LED3 blinks three times per second | Over-voltage charger detected |
|  | LED4 blinks twice per second | Charging temperature is too low |
|  | LED4 blinks three times per second | Charging temperature is too high |

If any of the battery protection mechanisms are activated, unplug the charger, and plug it in again to resume charging. If the charging temperature is abnormal, wait for it to return to normal. The battery will automatically resume charging without the need to unplug and plug in the charger again.

4.8 Gimbal and Camera

Gimbal Notice

-  • Make sure there are no stickers or objects on the gimbal before taking off. DO NOT tap or knock the gimbal after the aircraft is powered on. Launch the aircraft from open and flat ground to protect the gimbal.
- Remove the gimbal protector before powering on the aircraft. Attach the gimbal protector when the aircraft is not in use.
- Precision elements in the gimbal may be damaged by a collision or impact, which may cause the gimbal to function abnormally.
- Avoid getting dust or sand on the gimbal, especially in the gimbal motors.
- A gimbal motor may enter protection mode if the gimbal is obstructed by other objects when the aircraft is put on uneven ground or on grass, or if the gimbal experiences an excessive external force, such as during a collision. Wait for the gimbal to return to normal or restart the device.
- DO NOT apply external force to the gimbal after the aircraft is powered on.
- DO NOT add any extra payload other than an official accessory to the gimbal, as this may cause the gimbal to function abnormally or even lead to permanent motor damage.

- Flying in heavy fog or clouds may make the gimbal wet, leading to temporary failure. The gimbal will recover full functionality once it is dry.
- If there are strong winds, the gimbal may vibrate while recording.
- After powering on, if the aircraft is not placed flat for an extended period or if the it is significantly shaken, the gimbal may stop working and enter protection mode. In this case, place the aircraft flat and wait for it to recover.
- DO NOT use the aircraft in rainy or snowy weather. If encountering rain or snow during flight, land the aircraft immediately and clean the surface of the gimbal and gimbal motor promptly.
- If the gimbal tilt angle is large:
 - ◆ When the aircraft pitches forward due to forward acceleration or deceleration, the gimbal will enter limit protection mode and automatically adjust the angle downward.
 - ◆ When the aircraft rolls sideways due to lateral acceleration or deceleration, the gimbal yaw axis may reach movement limit.
 - ◆ The aircraft will restrict its speed to maintain image stabilization. In high wind conditions, flight speed will be further limited. Appropriately reducing the pitch angle can achieve higher flight speed.
 - ◆ The aircraft body may appear at the edge of the liveview.

Gimbal Angle

Use the gimbal dial on the remote controller to control the tilt of the gimbal. Alternatively, do so through the camera view in DJI Fly. Press and hold the screen until the gimbal adjustment bar appears. Drag the bar to control the gimbal's angle.

Gimbal Operation Modes

Two gimbal operation modes are available. Switch between the different operation modes in ***** > Control**.

Follow Mode: The angle of the gimbal remains stable relative to the horizontal plane. This mode is suitable for capturing stable images.

FPV Mode: When the aircraft is flying forward, the gimbal rolls in sync with the rolling aircraft to provide a first-person flying experience.

Camera Notice

- ⚠ • DO NOT expose the camera lens to an environment with laser beams, such as a laser show, or point the camera at intense light sources for an extended period of time, such as the sun on a clear day, in order to avoid damaging the sensor.
 - Make sure the temperature and humidity are suitable for the camera during use and storage.
 - Use a lens cleanser to clean the lens to avoid damage or poor image quality.
 - DO NOT block any ventilation holes on the camera, as the heat generated may damage the device or cause injury.
-

4.9 Storing and Exporting Photos and Videos

Storing

The aircraft comes with an internal storage. Photos and videos can be saved in the internal storage.

- ⚠ • Check camera settings before use to ensure they are configured correctly.
 - Before shooting important photos or videos, shoot a few images to test whether the camera is operating correctly.
 - Make sure to power off the device correctly. Otherwise, the camera parameters will not be saved, and any recorded videos may be affected. DJI is not responsible for any loss caused by an image or video recorded in a way that is not machine-readable.
-

Exporting

- Use QuickTransfer to export the footage to a mobile device. Refer to the follow-up section for more information.
- Connect the aircraft to a computer using a data cable, export the footage in the internal storage of the aircraft. The aircraft does not need to be powered on during the exporting process.

4.10 QuickTransfer

DJI Neo 2 can connect directly to a smartphone via Wi-Fi, enabling you to download photos and videos from DJI Neo 2 to the smartphone.

In Mobile App Control, after the smartphone is connected to DJI Neo 2, enter QuickTransfer mode by going to the Album view.

When DJI Neo 2 is not connected to the smartphone, you can tap the QuickTransfer or Wi-Fi Devices card on the home screen in DJI Fly to enter QuickTransfer mode. You can also go to Album in DJI Fly on your smartphone, and tap  in the upper right corner to enter QuickTransfer mode.

When connecting the smartphone to DJI Neo 2 for the first time, press and hold the power button of DJI Neo 2 to confirm.



- The maximum download rate can only be achieved in countries and regions where the 5.8 GHz frequency is permitted by laws and regulations, when using devices that support 5.8 GHz frequency band and Wi-Fi connection, and in an environment without interference or obstruction. If 5.8 GHz is not allowed by local regulations (such as in Japan), or your mobile device does not support the 5.8 GHz frequency band, or the environment has severe interference, then QuickTransfer will use the 2.4 GHz frequency band and its maximum download rate will reduce to 12 MB/s.
- When using QuickTransfer, it is not necessary to enter the Wi-Fi password on the settings page of the mobile device in order to connect. Launch DJI Fly and a prompt will appear to connect the device.
- Use QuickTransfer in an unobstructed environment with no interference and stay away from sources of interference such as wireless routers, Bluetooth speakers, or headphones.



- When viewing the album in QuickTransfer mode, ECO mode will be enabled automatically if the temperature of DJI Neo 2 raises above a certain value. And its maximum download rate will reduce to 30 MB/s. Pay attention to the prompt in the app.
-

DJI RC-N3

5 DJI RC-N3

5.1 Operations

Powering On/Off

Press the power button once to check the current battery level.

Press, then press and hold to power the remote controller on or off.

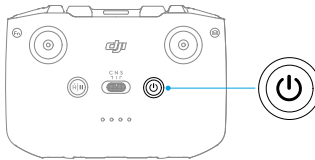

Charging the Battery

Connect the charger to the USB-C port on the remote controller.

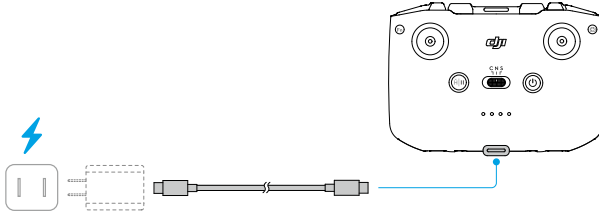

-
- ⚠ • Fully charge the remote controller before each flight. The remote controller sounds an alert when the battery level is low.
 - Fully charge the battery at least once every three months to maintain the battery's health.
-

Controlling the Gimbal and Camera

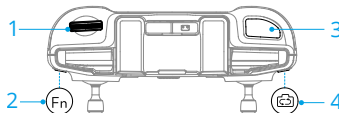

1. **Gimbal Dial:** Control the tilt of the gimbal.

- 2. **Customizable Button:** Press and hold the customizable button and then use the gimbal dial to zoom in or out.
- 3. **Shutter/Record Button:** Press once to take a photo or to start or stop recording.
- 4. **Photo/Video Button:** Press once to switch between photo and video mode.

Flight Mode Switch

Toggle the switch to select the desired flight mode.

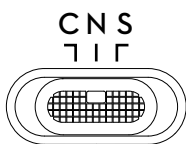

| Position | Flight Mode |
|----------|-------------|
| C | Cine Mode |
| N | Normal Mode |
| S | Sport Mode |

Flight Pause/RTH Button

Press once to make the aircraft brake and hover in place.

Press and hold the button until the remote controller beeps and starts RTH. The aircraft will return to the last recorded Home Point. Press the button again to cancel RTH and regain control of the aircraft.

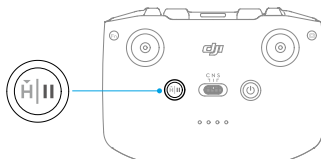



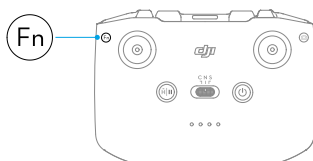

Customizable Button

To view and set the button function, go to camera view in DJI Fly, and tap *** > Control > Button Customization.



5.2 Battery Level LEDs

| Blinking Pattern | Battery Level |
|---|---------------|
|  | 76-100% |
|  | 51-75% |
|  | 26-50% |
|  | 0-25% |

5.3 Remote Controller Alert

The remote controller sounds an alert during RTH, which cannot be cancelled. The remote controller sounds an alert when the battery level of the remote controller is low. A low battery level alert can be cancelled by pressing the power button. When the battery level is critically low, the alert cannot be cancelled.

There will be an alert if the remote controller is not used for a period while it is powered on but is not connected to the aircraft or the DJI Fly app on the mobile device. The remote controller will automatically power off after the alert stops. Move the control sticks or press any button to cancel the alert.

5.4 Optimal Transmission Zone

The signal between the aircraft and the remote controller is most reliable when the antennas are positioned in relation to the aircraft as illustrated below. If the signal is weak, adjust the remote controller orientation, or fly the aircraft closer to the remote controller.

Optimal Transmission
Zone

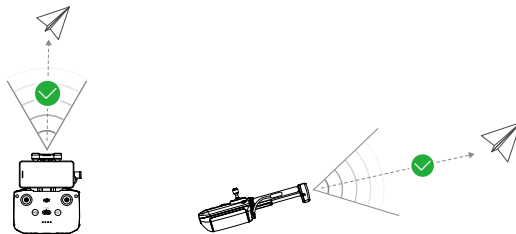

Weak Signal

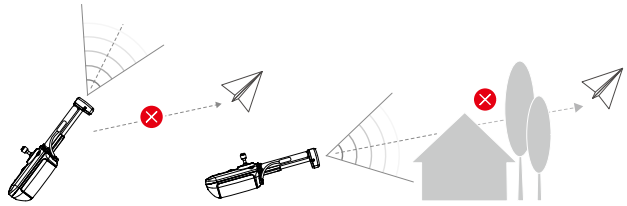

-
- ⚠ • DO NOT use other wireless devices operating at the same frequency as the remote controller. Otherwise, the remote controller will experience interference.
 - A prompt will be displayed in DJI Fly if the transmission signal is weak during flight. Adjust the remote controller orientation according to the attitude indicator display to make sure that the aircraft is in the optimal transmission range.
-

5.5 Linking the Remote Controller

The remote controller is already linked to the aircraft when purchased together as a combo. Otherwise, follow the steps below to link the devices.

1. Power on the aircraft and the remote controller.
2. Launch DJI Fly.
3. In camera view, tap *** > **Control** > **Re-pair to Aircraft**. During linking, the remote controller beeps.
4. Press and hold the power button of the aircraft for more than four seconds. The aircraft beeps, and its battery level LEDs blink in sequence to indicate it is ready to link. The remote controller will beep twice to indicate linking is successful.

-
- 💡 • Make sure the remote controller is within 0.5 m of the aircraft during linking.
 - The remote controller will automatically unlink from an aircraft if a new remote controller is linked to the same aircraft.
-

Appendix

6 Appendix

6.1 Specifications

Visit the following website for specifications.

<https://www.dji.com/neo-2/specs>

6.2 Compatibility

Visit the following website to get the information on compatible products.

<https://www.dji.com/neo-2/faq>

6.3 Firmware Update

Use DJI Fly or DJI Assistant 2 (Consumer Drones Series) to update the device.

Using DJI Fly

When using Mobile App Control, update the firmware according to the prompt on the home screen in DJI Fly. An internet connection is required during the firmware update.

When using the remote controller, connect the aircraft and remote controller, and run DJI Fly. You will be notified if a new firmware update is available. Follow the on-screen instructions to start the update. Note that you cannot update the firmware if the remote controller is not linked to the aircraft. An internet connection is required during the firmware update.

When using Immersive Motion Control, power on the aircraft, goggles, and remote control device, and make sure all the devices are linked. Connect the USB-C port of the goggles to the smartphone. Run DJI Fly, and follow the prompt to update. An internet connection is required during the firmware update.

Using DJI Assistant 2 (Consumer Drones Series)

Use DJI Assistant 2 (Consumer Drones Series) to update all your devices separately.

1. Power on the device. Connect the device to a computer with a USB-C cable.
2. Launch DJI Assistant 2 (Consumer Drones Series) and log in with your DJI account.
3. Select the device and click **Firmware Update** on the left side of the screen.
4. Select the firmware version.

5. Wait for the firmware to download. The firmware update will start automatically. Wait for the firmware update to complete.



- The battery firmware is included in DJI Neo 2 firmware. Be sure to update all batteries.
- Make sure to follow all the steps to update the firmware, otherwise the update may fail.
- Make sure the computer is connected to the internet during the update.
- DO NOT unplug the USB-C cable during an update.
- Before performing an update, make sure that the device is at least 20% charged.
- The firmware update will take approximately 10 minutes. During the update process, it is normal for the gimbal to go limp, the status indicator to blink, and DJI Neo 2 to reboot. Wait patiently for the update to complete.

Visit the following link and refer to the *Release Notes* for firmware update information:

<https://www.dji.com/neo-2/downloads>

6.4 Flight Recorder

Flight data including flight telemetry, aircraft status information, and other parameters are automatically saved to the internal data recorder of the aircraft. The data can be accessed using DJI Assistant 2 (Consumer Drones Series).

6.5 Post-Flight Checklist

- Make sure to perform a visual inspection so that the aircraft, remote controller, gimbal camera, Intelligent Flight Batteries, and propellers are in good condition. Contact DJI support if any damage is noticed.
- Make sure that the camera lens and vision system sensors are clean.
- Make sure to store aircraft correctly before transporting it.

6.6 Maintenance Instructions

To avoid serious injury to children and animals, observe the following rules:

1. Small parts, such as cables and straps, are dangerous if swallowed. Keep all parts out of reach of children and animals.

2. Store the Intelligent Flight Battery and remote controller in a cool, dry place away from direct sunlight to ensure the built-in LiPo battery does NOT overheat. Recommended storage temperature: between 22° and 28° C (71° and 82° F) for storage periods of more than three months. Never store in environments outside the temperature range of -10° to 45° C (14° to 113° F).
3. DO NOT allow the camera to come into contact with or become immersed in water or other liquids. If it gets wet, wipe dry with a soft, absorbent cloth. Turning on an aircraft that has fallen in water may cause permanent component damage. DO NOT use substances containing alcohol, benzene, thinners, or other flammable substances to clean or maintain the camera. DO NOT store the camera in humid or dusty areas.
4. Check every aircraft part after any crash or serious impact. If there are any problems or questions, contact a DJI authorized dealer.
5. Regularly check the Battery Level Indicators to see the current battery level and overall battery life. The battery is rated for 200 cycles. It is not recommended to continue use afterward.
6. Make sure to transport the aircraft with the arms folded when powered off.
7. Make sure to transport the remote controller with antennas folded when powered off.
8. The battery will enter sleep mode during long-term storage. Charge the battery to exit from sleep mode.
9. Store the aircraft, remote controller, battery, and charger in a dry environment.
10. Remove the battery before servicing the aircraft (e.g., cleaning or attaching and detaching the propellers). Make sure that the aircraft and the propellers are clean by removing any dirt or dust with a soft cloth. Do not clean the aircraft with a wet cloth or use a cleanser that contains alcohol. Liquids can penetrate the aircraft housing, which can cause a short circuit and destroy the electronics.

6.7 Troubleshooting Procedures

1. How to solve the gimbal drift issue during flight?

Calibrate IMU and compass in DJI Fly. If the problem persists, contact DJI Support.

2. No function

Check if the Intelligent Flight battery and the remote controller are activated by charging. If the problems persist, contact DJI Support.

3. Power-on and start-up problems

Check if the battery has power. If yes, contact DJI Support if it cannot be started normally.

4. Firmware update issues

Follow the instructions in the user manual to update the firmware. If the firmware update fails, restart all the devices and try again. If the problem persists, contact DJI Support.

5. Procedures to reset to factory default

Use the DJI Fly app to reset to factory default settings.

6. Shutdown and power-off problems

Contact DJI Support.

7. How to detect careless handling or storage in unsafe conditions

Contact DJI Support.

6.8 Risks and Warnings

When the aircraft detects a risk after powering on, there will be a warning prompt on DJI Fly. Pay attention to the list of situations below.

- If the location is not suitable for takeoff.
- If an obstacle is detected during flight.
- If the location is not suitable for landing.
- If the compass and IMU experience interference and need to be calibrated.
- Follow the on-screen instructions when prompted.

6.9 Disposal



Observe the local regulations related to electronic devices when disposing of the aircraft and remote controller.

Battery Disposal

Dispose of the batteries in specific recycling containers only after a complete discharge. DO NOT dispose of the batteries in regular trash containers. Strictly follow the local regulations regarding the disposal and recycling of batteries.

Dispose of a battery immediately if it cannot be powered on after over-discharging.

If the power button is disabled and the battery cannot be fully discharged, contact a professional battery disposal/recycling agency for further assistance.

6.10 C0 Certification

DJI Neo 2 is compliant with C0 certification requirements. There are some requirements and restrictions when using DJI Neo 2 in EU member states, EFTA member states (EFTA, i.e. Norway, Iceland, Liechtenstein, Switzerland) and Georgia.

| | |
|------------------------------|-----------|
| Model | DEN225 |
| UAS Class | C0 |
| Maximum Take-Off Mass (MTOM) | 160 g |
| Maximum Propeller Speed | 43820 RPM |

MTOM Statement

The MTOM of DJI Neo 2 (Model DF1A0424) is 249 g to comply with C0 requirements.

You must follow the instructions below to comply with the MTOM requirements.

- DO NOT add any payload to the aircraft except the items listed in the List of Items including qualified accessories section.
- DO NOT use any non-qualified replacement parts, such as intelligent flight batteries or propellers, etc.
- DO NOT retrofit the aircraft.

List of Items, including qualified accessories

| Item | Model Number | Dimensions | Weight |
|-------------------------------|------------------|------------------------|----------------|
| Propellers | R2217S | 55.88x43.18mm | 1.52 g (Pair) |
| Propeller Guard | PG020 | 47.18x171.81mmx16.72mm | 8.1 g (Pair) |
| Intelligent Flight Battery | BWXEN2-1606-7.16 | 77.43x40.72x20.21 mm | Approx. 46.7 g |
| DJI Neo 2 Digital Transceiver | DEP1 | N/A | Approx. 9g |

List of Spare and Replacement Parts

- DJI Neo 2 Propellers
- DJI Neo 2 Propeller Guard
- DJI Neo 2 Intelligent Flight Battery
- DJI Neo 2 Digital Transceiver

Remote Controller Warnings

DJI RC-N3

The battery level LEDs will start blinking slowly after disconnecting from the aircraft. DJI Fly will issue a warning prompt after disconnecting from the aircraft. The remote controller will beep and power off automatically after disconnecting from the aircraft and with no operation for a long time.



- Avoid interference between the remote controller and other wireless equipment. Make sure to turn off the Wi-Fi on nearby mobile devices. Land the aircraft as soon as possible if there is interference.
 - Release the control sticks or press the flight pause button if an unexpected operation occurs.
 - When using Mobile App Control, DJI Fly will issue a warning prompt after disconnecting from the aircraft.
-

EASA Notice

Make sure to read the Drone Information Notices document included in the package before use.

Visit the link below for more EASA notice information on traceability.

<https://www.easa.europa.eu/en/document-library/general-publications/drones-information-notices>

Original Instructions

This manual is provided by SZ DJI Technology, Inc., and the content is subject to change.

Address: Lobby of T2, DJI Sky City, No. 53 Xianyuan Road, Xili Community, Xili Street, Nanshan District, Shenzhen, China, 518055.

6.11 Aftersales Information

Visit <https://www.dji.com/support> to learn more about aftersales service policies, repair services, and support.



Contact
DJI SUPPORT

This content is subject to change without notice.
Download the latest version from



<https://www.dji.com/neo-2/downloads>

If you have any questions about this document, please contact DJI by sending a message to DocSupport@dji.com.

DJI and NEO is a trademark of DJI.
Copyright © 2025 DJI All Rights Reserved.