

GHOSTDRONE 2.0

OPERATING MANUAL

GHOSTDRONE 2.0 VR

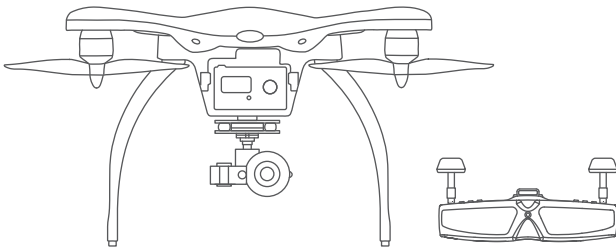

EHANG

GHOSTDRONE 2.0 Operating Manual
includes packing list, assembly, parts
and specification information.

Congratulations on purchasing your new GHOSTDRONE 2.0!
For customer service and support, please e-mail support@ehang.com
or contact our customer service hotline: 888-800-7056.

www.ehang.com
www.twitter.com/ehang
www.facebook.com/theghostdrone
www.instagram.com/ehang.official/

Thank you, and enjoy your GHOSTDRONE!

www.ehang.com
Business Hour: Monday – Friday 9:00 A.M – 5:00 P.M (PST)
Customer Service Phone: +1 650-533-8554 / 888-800-7056
Customer Service Email: support@ehang.com
ENTERPRISE STANDARD: Q/ EHT 001-2017
EHang, Inc. reserves the right to interpret this Operating Manual.

GHOSTDRONE 2.0 VR

TABLE OF CONTENTS

Warning

Warning	03
---------	----

Introduction

GHOSTDRONE	05
VR Goggles	05

Assembly

Propellers	06
Propeller Guards	08

Accessories

Smart Flight Battery	09
3D Gimbal for Spherical Camera	14
Spherical Camera	14
VR Goggles	15
Copter Indicator Lights Instructions	21

Specifications

Specifications	22
----------------	----

App Download

App Download	25
Supported Device Requirements	25

FAQ

FAQ	26
-----	----

WARNINGS

Before flying, please consult flight documentation from the International Civil Aviation Organization (ICAO) and Federal Aviation Administration (FAA) regarding unmanned aircraft operation. The user is responsible for his or her actions and any ensuing consequences. Users are hereby advised that they are liable for the use of the GHOST-DRONE and any and all liability is solely theirs. Please fly responsibly.

1. If you are flying your GHOSTDRONE 2.0 for the first time, please fly it in an open area in order to experience its various functions safely.
2. DO NOT fly in restricted air zones.
3. DO NOT fly near obstacles, people, power lines, trees, above waters or any other environments which are not safe for flying.
4. The copter may not fly properly near tall buildings and metal structures due to GPS interferences.
5. DO NOT fly in or around congested electromagnetic (EM) environments. The copter must be kept at least 200 m (656 ft.) away from strong EM source to operate properly. EM interference can cause a loss of communication with the copter and result in damage to properties or hurting other people.
6. Do not fly the copter in adverse weather conditions, including extreme temperatures, heavy snow, strong wind, storm or fog.
7. It is recommended to always retain line-of-sight with the copter during flight. Losing sight of the copter may result in accidents.
8. GHOSTDRONE is not suitable for use by children under 14 years of age. Adult supervision is required if the copter is operated by children.
9. Please make sure your mobile device, VR goggles, and the copter have sufficient battery before flying.
10. Stand clear of the copter (at least 5m or 16 ft.) with its head facing away from you when ready to fly.
11. Compass must be re-calibrated if the icon ▲ in the App points at a significantly different direction than the copter's actual orientation. If the difference persists after calibration, please choose a new environment for flying.

12. To avoid injury, DO NOT approach or touch the propellers or motors while they are spinning.

13. Keep the VR goggles within 3 meters from you during flight. DO NOT put the VR goggles on the floor or in the pocket. If the the VR goggles is not near you, you may lose connection with the copter.

14. Please keep an eye on the copter's battery shown on the App interface. We strongly suggest to land the drone when the battery is low.

15. Please tap Hover button in case of any emergencies. The copter will stop moving and hover at its current position. If it fails to hover, please secure your personal safety first.

16. For your safety, Avatar Mode will be unlocked after you have flown in Touch-to-go Mode for 3 times. It is important for you to familiarize yourself with the Avatar manual mode to ensure flight safety. In Avatar manual mode, the copter flies only using gyroscope and accelerometer, other sensors are not used in this mode. This mode is safe but users need to control every movement of the copter. If you are flying Avatar manual mode for the first time, to ensure precise manual operation, please fly the copter in open area and only use this mode when the copter is 30 meters above the ground.

INTRODUCTION

With dual-sensor flight controller and high efficiency dynamic system, GHOSTDRONE 2.0 provides a safer and more stable fly experience. Its newly equipped smart batteries can display real-time battery status so you can always keep track of your drone's battery life. And the GHOSTDRONE 2.0 Aerial version contains the 3D gimbal we developed, which ensures the Spherical Camera to be always steady and stable and capable of recording all the exciting moments in your life.

■ GHOSTDRONE

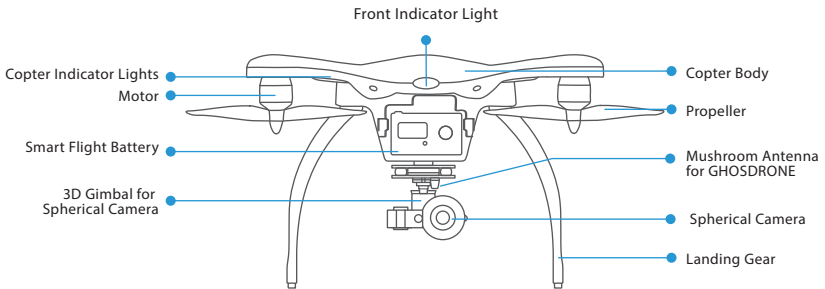

■ VR goggles

1. 2.4G Antenna
2. ON/OFF
3. Channel Search
4. Copter/ Front Camera
5. Power Indicator
6. Data Signal

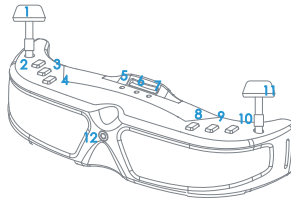

7. Vision Signal
8. Menu
9. Up
10. Down
11. 5.8G Mushroom Antenna
12. Lens

■ Connect Device



ASSEMBLY

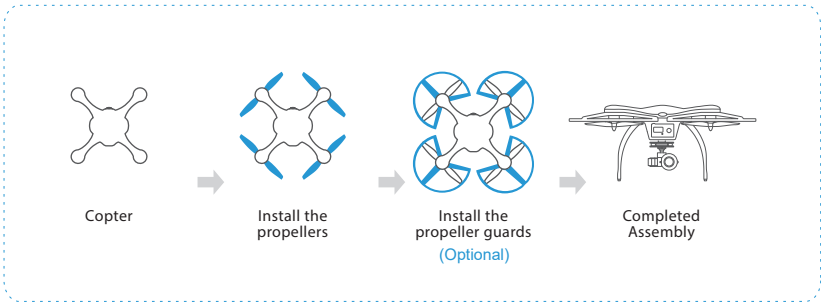

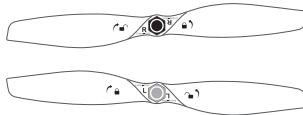

Propellers

GHOSTDRONE 2.0 uses 2-bladed 8.5-inch self-tightening propellers. Propeller nuts have two colors, silver and black. Each indicates different rotating directions.



Legends

 LOCK: Tighten the propeller in this direction.

 UNLOCK: Remove the propeller in this direction.

Installation

1. Put the copter upside down on soft surface to avoid scratches.
2. Match the silver nut propellers with the L motors (with silver motor shaft), and tighten the propellers according to the LOCK instructions.

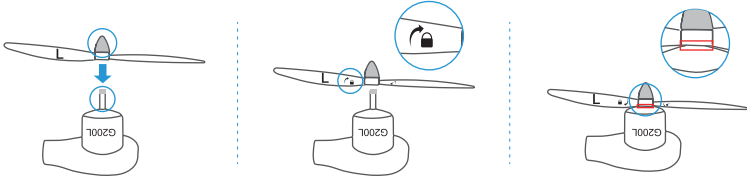

3. Attach the black nut propellers to the R motors in the same way.

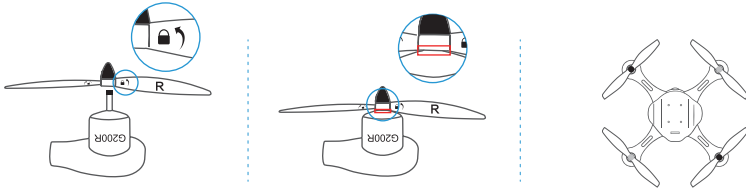

Disassembling

Keep the motor deadlocked in place with one hand and remove the propeller according to the unlock instructions.

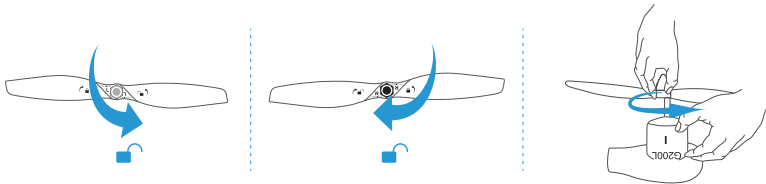

Warning

1. Check that the propellers and motors are installed correctly and firmly before each flight.
2. It is necessary to check that all propellers are in good condition before take-off.
3. DO NOT use any aged, deformed or damaged propellers.
4. To avoid injury, DO NOT approach or touch the propellers or motors while they are spinning.
5. For a better flight experience, please use EHang proprietary propellers.
6. For a better and safer flight experience, please use original EHang propellers. EHang does not offer warranty for propellers. If you need to replace your propellers, please go to our website www.ehang.com

Propeller Guards

Warning

Propeller guards must be installed when flying indoors. EHang will not be liable for any accidents caused by not installing the propeller guards. However, guards are not recommended to be installed when flying in outdoor environments, the extra load and wind resistance of installing the guards might have negative impact on flying experiences.

Installation: Place the guards over the copter. Use the screwdriver to tighten the 3 screws.
Disassemble: Unscrew the three holding screws and remove the guard.

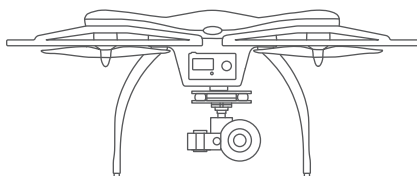
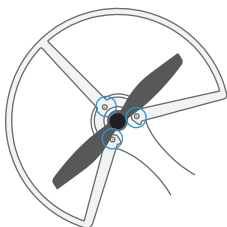
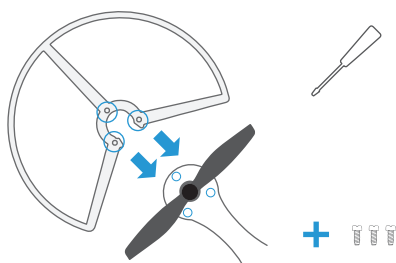

Completed Assembly

ACCESSORIES

Smart Flight Battery

⚠ Improper use of battery may lead to fire, explosion or other dangers. Please be familiar with the product before using.

The smart flight battery is specially designed for the GHOSTDRONE 2.0, with capacity of 4500 mAh, voltage of 14.8 V, charge-discharge management functionality and a smart display screen. The battery should only be charged by EHang power adapter.

Battery Diagram

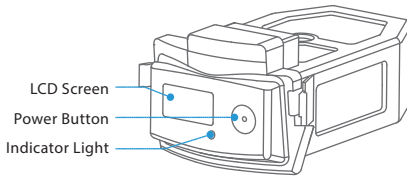

Powering On

Press the power button shortly, then quickly press and hold the button again. Don't release it until the last letter "G" of logo "EHANG" fully appeared on the screen. The LED indicator light turns on once the battery is turned on, referring to the diagram below.

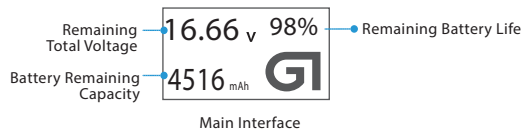

Note: When the battery is powered off, press the power button to check the battery life. (Main interface will display for 3 seconds while the LED Indicator light stays off during the whole process.)

After turning on the battery you can enter the battery status interface by clicking the on button, to return to the main interface click the on button again.

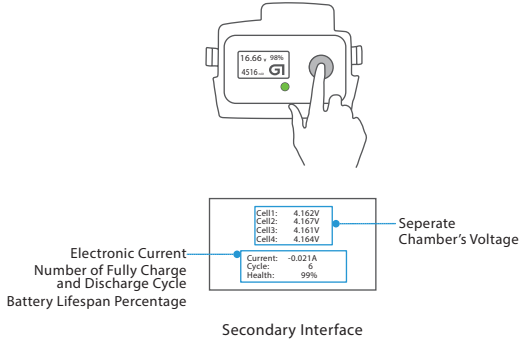

Powering Off

Press the power button shortly, then press and hold again until the '!' of 'SEE YOU !' message disappears on the screen.



Battery Removal & Installation

Remove Battery

Turn off the battery first. Hold the battery handles to remove it from the battery compartment.

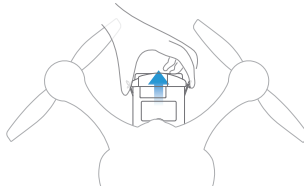

Install Battery

Hold the battery handles and push the battery into the battery compartment until you hear a click.

Note: DO NOT remove or install the battery into the copter when it is powered on, otherwise the battery will be damaged.

Battery Charging

Connect the battery to the power adapter, and then connect the power adapter to a wall socket (use the plug if necessary). Once connected successfully, the LED indicator light flashes slowly and the screen displays current battery information as below:

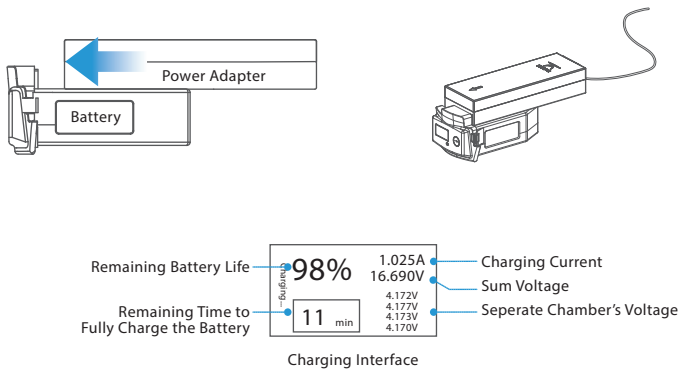

Battery Discharging

When the battery is discharging, the LED indicator light stays on and the screen displays as below:

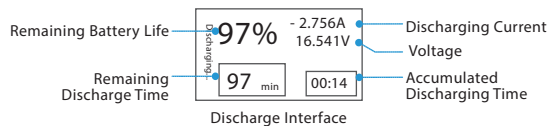

LED Indicator Light Instructions

	Low frequency flash (Green)	Charging
	High frequency flash (Green)	Low battery
	Solid green	Working
	Light off	Standby

Warning

1. Only the EHang power adapter should be used to charge the battery.
2. DO NOT use batteries from other companies for the GHOSTDRONE. EHang is not responsible for any accidents caused by third party batteries.
3. DO NOT use used LiPo batteries. EHang is not responsible for any dangerous accidents caused by used batteries.
4. DO NOT use the battery if it is inflated, damaged or deformed. DO NOT charge or discharge the battery if it is inflated, damaged or deformed.
5. DO NOT plug or unplug the battery into the copter when it is powered on, otherwise the battery will be damaged.
6. DO NOT overcharge the battery. DO NOT "trickle" charge the battery.
7. DO NOT leave the battery unattended when charging for a long time.
8. DO NOT charge or store the battery under direct sunlight. Please store batteries at room temperature. DO NOT store batteries under high or low temperature condition.
9. Recharge the battery only after it cools down to room temperature. Use the charged battery only after it cools down to room temperature.
10. DO NOT use the battery in strong electrostatic or electromagnetic environments, otherwise the electronic protection devices might be damaged leading to dangerous accidents.
11. DO NOT use any conducting wires or any metallic substance that would cause batteries to develop a short circuit.
12. DO NOT attempt to dismantle the battery case. DO NOT attempt to dismantle, pierce or cut a battery.
13. DO NOT discharge the battery below 3.0V per cell. Ideally you never want to go below 3.2V per cell to maintain a healthy battery. 2.9V per cell and lower will cause permanent damage.
14. DO NOT leave the battery sitting around on a full charge for more than 2-3 days. If by the 3rd day you realize you are not going to use your battery, you need to discharge your battery down to 3.6V-3.8V per cell for safe storage until you are ready to use the battery again.
15. Depending on how they are used, most LiPo batteries typically do not last longer than 300 charge cycles. Leaving the batteries around on a full or depleted charge all the time, running them completely dead, or exposing them to high temperatures will shorten this lifespan dramatically.
16. Always pack your batteries in your carry-on bag and never in your checked baggage when traveling on an airplane. It's the law.

Storage Instructions

1. The battery should be stored in an environment with the temperature of $23\pm 5^{\circ}\text{C}$.
2. The battery must be stored in places away from children, water, fire and metal.
3. Always keep a Class D fire extinguisher near your battery charging/discharging and storage area. The battery charging/discharging and storage area should be free from any materials which can catch fire such as wooden tables, carpets, or gasoline containers. The ideal surfaces for charging and storing batteries are concrete or ceramic.
4. DO NOT use your flight case/travel case for long term battery storage. The foam and plastic in these cases can help spread a fire caused by batteries. Always use a fire proof container such as a metal ammo box or fire proof safe for storage.
5. If the battery is not being used for more than 1 week, keep the battery capacity between 50% to 60%. Charge and discharge the battery once every two months.
6. Do not discard batteries in general household waste. Damaged or unusable batteries must be disposed in containers specially reserved for this purpose. When disposing of batteries, follow appropriate local guidelines and regulations.

3D Gimbal for Spherical Camera

The 3D Gimbal for Spherical camera is equipped with a specialized 3D gimbal. Its ultra-thin motor makes it very light and responsive. The same time, we adopt the bracketing gimbal design makes the gimbal and the camera more stable.

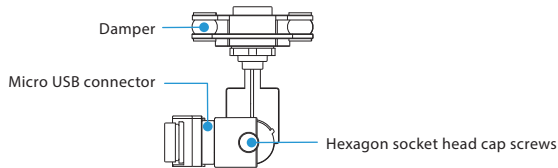

Note: You can access the data in your camera by plugging the USB cable into the Micro USB port on the gimbal.

Spherical Camera

Spherical camera is lightweight with a design that tremendously reduces wind friction, especially under air turbulence when maneuvering at high speed. It has low picture deformation and performs well under low illumination conditions.

Spherical camera supports up to 30 frames per second high quality video recording with 4K resolution, and up to 12 mega pixel images. Standard storage is 16 GB Class 10 Micro SD card, and supports up to 64 GB. Micro SD card with Class 10, UHS-1 or higher is recommended to support high speed video data storage.

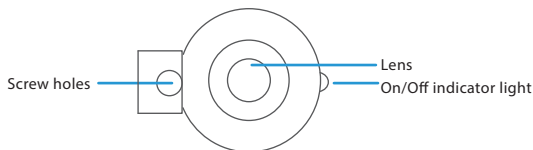

How to use the camera

Turn On / Off:

The camera will turn on when the GHOSTDRONE is turned on;

The camera turns off when the GHOSTDRONE is off.

Recording: The indicator light on the camera will be on when the camera is turned on.

- 1) Press On/Off button on the camera when the indicator light is on, then the light will start blinking which means the recording has started.
- 2) While recording, press the On/Off button to stop and the indicator light will stop blinking as well to reflect the status.

App control

You can control the camera's start and stop recording in the flying interface of the App. Click the camera recording icon once to start recording and click again to stop. You can also take photos by clicking the photo button located next to the recording button (Note: Photos cannot be taken while the camera is recording). You can change various settings regarding the video's size, frame rate and standard in the camera settings menu in EHANG Play App.

VR goggles

EHang VR goggles features data and real-time video transmission functions. While wearing the goggles, users can easily see real-time image through head tracking as well as adjusting pitch angles of the camera which is attached on GHOSTDRONE 2.0.

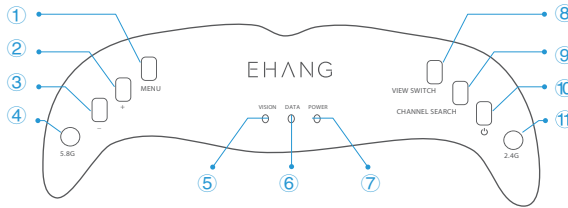

Above

- | | | |
|--------------------------|-------------------|--------------------------|
| ① Menu | ⑤ Vision Signal | ⑨ Channel Search |
| ② Up | ⑥ Data Signal | ⑩ ON/OFF |
| ③ Down | ⑦ Power Indicator | ⑪ 2.4G Antenna Interface |
| ④ 5.8G Antenna Interface | ⑧ View Switch | |

Instructions

1. Install 5.8G antenna and 2.4G antenna to the corresponding antenna interfaces.

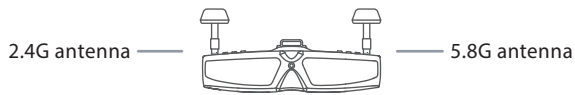

2. Press and hold the power button to turn on the VR goggles. Power indicator displays solid red. DATA signal indicator flashes blue. After turning the VR goggles on, you can check the battery in the lower right corner.

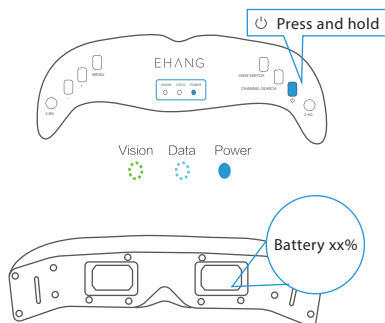

3. Bluetooth / Wi-Fi Connection

1) Android version: Launch the App to search for Bluetooth connection. Once the connection is established, the DATA signal indicator will display solid blue.

2) iOS version: Turn the iPhone's Wi-Fi switch on. Once the Wi-Fi connection is established, launch the App, then the DATA signal indicator will display solid blue. And confirm Wi-Fi connection in App. The name and password for goggle's Wi-Fi is on the sticker on the bottom of the VR goggle.



4. Tap "Bind" in the App, then turn on the GHOSTDRONE 2.0, data will be showed on the App interface once binding successfully.

5. Press CHANNEL SEARCH button to automatically search for the right channel. Vision signal indicator turns solid green from flashing when connection is successfully established.

Note: If the image is not clear enough, press CHANNEL SEARCH button to search again.

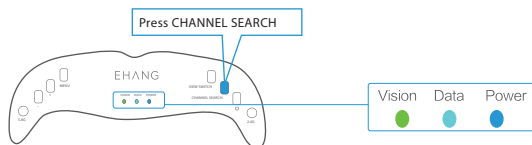

6. If you want to use the goggles to control the camera's pitch angle, choose "Goggles" in Flight settings in App before flight.

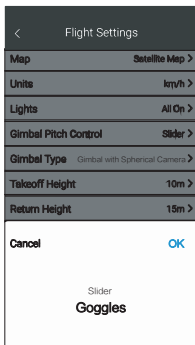

7. Put on the VR goggles, you can adjust the camera pitch angle by looking up or down.

8. Press and hold the power button to turn off the VR goggles if it is not in use.



Note: Press the power button once after plugging in the cable to charge the VR goggles. Please finish three times full charge and discharge when you use the goggles first time. That can make the battery show more accurate.

Note:

1. Press VIEW SWITCH button to switch from video transmission mode to goggle front camera. Users can watch the front view through the goggle front camera. To switch back to video transmission mode, press this button again.
2. After automatically searching the channel successfully, the channel will be recorded and no need to search again next time.
3. It is normal to observe some white noise on the screen.



Charging











You can charge the VR goggles by connecting it to a PC with a USB cable. It takes about 3 hours to fully charge the goggles. When charging through a USB adapter, the required input current is 500 mA or higher.

Note: Press the power button once after plugging in the cable to charge the VR goggles. Please finish three times full charging and discharging when you use the goggles first time. That can make the battery show more accurate.

Indicator Lights Instructions

Legend

 High Frequency
  Low Frequency Flash
  Solid
  Off

Power Indicator		Power On
		Battery life \leq 30%
		Charging
		Power Off/ Fully Charged
Data Signal Indicator		Searching for Bluetooth
		Bluetooth/ Wi-Fi Connects Successfully
		Power Off
Vision Signal Indicator		Image Transmission Mode On
		Searches Channel Successfully.
		Power off/ Switch to Front Camera

Menu Settings

The parameters in the menu have been correctly set to general settings before delivery. Adjust only when necessary.

When turning the goggles on, press the MENU button to enter the menu. Press "+" or "-" button to move up or down to choose the parameter for adjustment. Press the MENU Button again to select the parameter. Adjust the parameter with the "+" or "-" button. Press MENU Button again to exit.

Note:

1. After entering menu, if no further command is given in 2 seconds, the menu will disappear.
2. If unable to find a clear channel, please enter into Menu to change the frequency band or switch between CH NUM 32 or CH NUM 5.

B	6	Brightness
S	10	Saturation
C	8	Contrast
CH	17	Current 5.8G Channel (Adjustable)
CH	SRCH	5.8G Automatically Search Channel
RESET DATA		Reset to Factory Settings
CONNECT ON		Connection Status
ANGLE $\pm 90^\circ$		Head Tracking Angle
CH NUM 32		Frequency Band
EXIT MENU		Exit Menu

Head Tracking Angle

1. $\pm 45^\circ$

When the goggles head tracking range is set to $\pm 45^\circ$, gimbal is more sensitive to head movement.

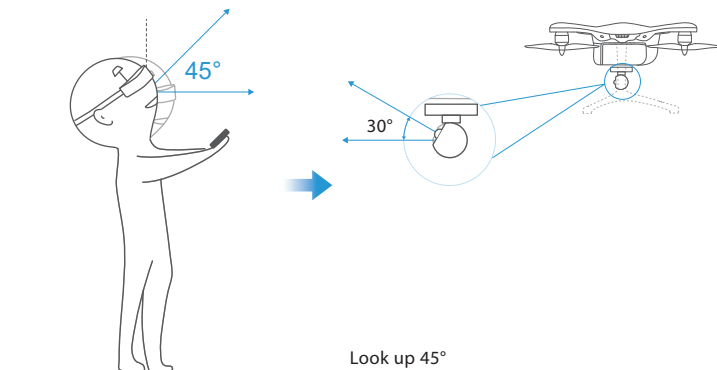

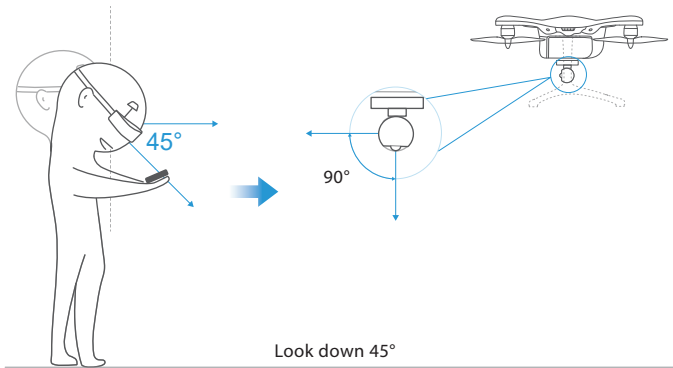

2. ±90°

When the goggles head tracking range is set to ±90°, gimbal is less sensitive to head movement.

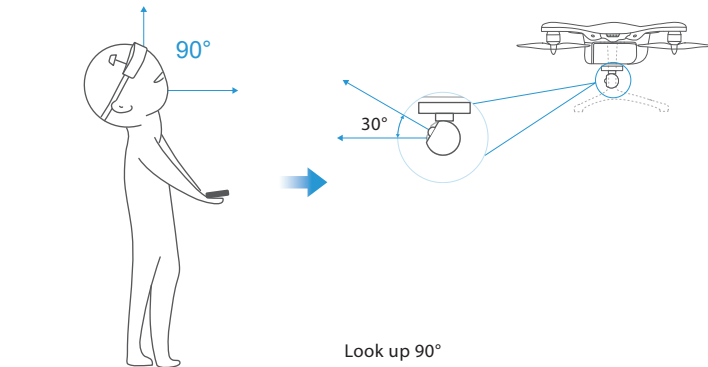

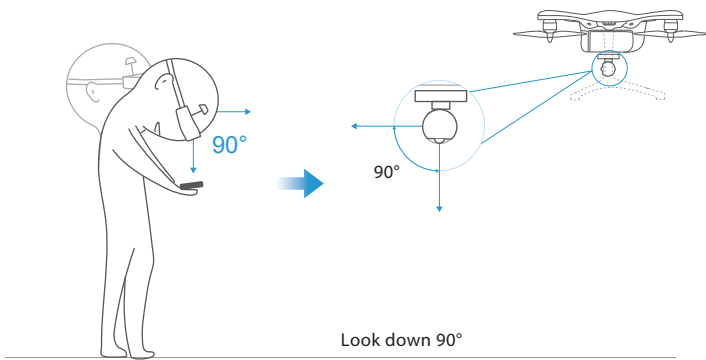

⚠ Warnings

1. Keep the smartphone and the VR goggles within 3 meters' range when using the goggles.
2. Use the goggles in open space. Avoid using it around complex structures or dangerous areas. (such as near cliffs)
3. Users with eye conditions are not recommended to use the VR goggles.
4. It is suggested not to wear the VR goggles continuously for over 90 minutes.
5. When the battery of the goggles is less than 10%, it is not suggested to keep using it. Please recharge before using again.
6. Please get familiar with the Menu and the buttons' functions before using the VR goggles.
7. DO NOT use the goggles in direct sunlight .
8. DO NOT disassemble or damage the case of the goggles.
9. DO NOT pierce or damage the adjustable headband.
10. DO NOT leave the goggles near combustibles or unattended when charging for a long time.
11. DO NOT bend the antennas on the goggles. If the antennas are damaged due to improper use, EHang will not offer complimentary maintenance.

⚠ Storage Instructions

1. Please store the goggles at room temperature.
2. The goggles must be stored in places away from children, water, fire especially heat.
3. Do NOT discard batteries in general household waste. Damaged or unusable goggles batteries must be disposed in containers specially reserved for this purpose. When disposing of batteries, follow appropriate local guidelines and regulations.

Copter Indicator Lights Instructions

On GHOSTDRONE 2.0, there are four arm indicator lights and one front indicator light. The front indicator light displays multiple colors; the two front arm indicator lights display red; and the rear two lights display blue.

The following chart describes the display status of the lights and their corresponding explanation.

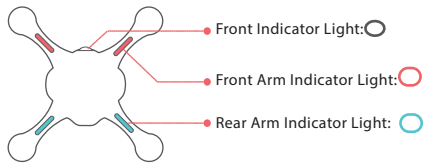

Legend

○ High Frequency

○ Low Frequency Flash

● Solid

Front Indicator Light	Arm Indicator Light	Descriptions
○ After powering on, front indicator light shows in white solid color then flashes in blue and green at high frequency until stop	● ● → ○ ○	Initializing.
○ Flashes in yellow and blue at low frequency alternately	○ ○	Control signal not receive.
○ High frequency flash (red)	○ ○	Unlock check failed, do not unlock.
○ Low frequency flash (yellow)	○ ○	GPS is not 3D locked. Unlock is only accessible in manual mode.
○ Low frequency flash (blue)	○ ●	GPS is 3D locked. Ready to unlock.
● Solid yellow	● ○	GPS is not 3D locked. Unlock successful.
● Solid green	● ●	GPS is 3D locked. Unlock successful.
○ Low frequency flash (yellow)	○ ○	Low battery. (Not related to unlock or not.)

Aircraft Indicator Light Status Information Chart

Terminologies

3D Lock: Lock copter's current three-dimension location using GPS.

High Frequency Flash: Flash rapidly.

Low Frequency Flash: Flash slowly.

SPECIFICATIONS

Copter

Weight	1150 g (with battery and propeller, without propeller guards)
Shaft Distance	350 mm
Height	195 mm
Hover Accuracy	horizontal: ± 1 , vertical: ± 0.2 m
Maximum Tilt Angle	$\pm 45^\circ$
Maximum Horizontal Speed	40 km/h (GPS mode) / 70 km/h (Manual mode)
Maximum Ascending Speed	2.5 m/s
Maximum Descending Speed	1.5 m/s
Maximum Hover Time	25 min
Communication Frequency	2.400 GHz - 2.483 GHz
Maximum Communication Distance	1000 m
Recommended Working Distance	500 m
Output Power	255 W (Hover) 450 W (Maximum)
Operating Temperature	-10°C - 40°C
Wind Resistance	< 10.7 m/s (24 mph)

Smart Flight Battery

Weight	400 g
Type	LiPo 4S
Voltage	14.8 V
Current	4500 mAh (67 Wh)
Operating Temperature	-10°C~ +40°C
Maximum Charging Power	60 W
Charging Time	60 min ~70 min

Power Adapter

Input Voltage	100 V~240 V
Input Current	2 A
Input Frequency	50/60 Hz
Output 1	DC 16.8 V 3.5 A
Output 2	DC 5 V 2 A
Rated Power	60 W
Operating Temperature	0°C~40°C
Storage Temperature	-20°C~85°C

■ 3D Gimbal for Spherical Camera

Weight	115 g
Static Accuracy	±0.03°
Dynamic Accuracy	±0.1°
Controllable Range	Yaw -45° to +45°/ Pitch Angle -90° to +30°
Supported Cameras	Spherical Camera

■ Spherical Camera

Weight	45g
Dimension	57*49*45 mm
Lens	F/2.8 93°
ISO	100 – 800
Effective Pixels	12MP(12 mega pixel)
Video/Photo Format	MOV/JPG
Compressed Format	H.264
Video	4K@30fps
Storage	Micro SD memory card with Class 10 or UHS-1 rating, up to 64 GB

Live Stream Video

Frequency	5.725 GHz~5.850 GHz
Maximum Operating Distance	1000 m
Stable Transmission Distance	500 m

VR goggles

Communication	Bluetooth / Wi-Fi + 2.4 GHz Data Transmission + 5.8 GHz Video transmission
Weight	255 g
Power	4.5 W
Charging Voltage	DC 5 V
Battery	3.7 V 1700 mAh
Image Size	854*480
Interpupillary Distance (IPD)	63 mm
Battery Life	60 min

App Download

App Download

Option① Visit official website www.ehang.com to download EHANG Play App

Option② Search and download EHANG Play Android version in [Google Play](#)

Option③ Search and download EHANG Play iOS version in [App Store](#)

Supported Device Requirements

Android: Android 4.0 or above.

iOS: iOS 8.0 or above.

Note:

Please visit: www.ehang.com to download *EHANG Play App Manual* and learn how to use the App.

FAQ

Copter

1. Is the VR goggles compatible with both Android and iOS?

Not. GHOSTDRONE 2.0 VR goggles is not compatible with both Android and iOS. You should choose what kind of goggles you want.

2. What's the battery capacity? How long is the charging time?

GHOSTDRONE 2.0 is equipped with 4500-mAh 4S Lithium polymer smart flight battery. The battery's LCD screen displays information including battery capacity, voltage, remaining capacity etc. The charging time is about 60 to 70 minutes, which will also be displayed on the screen during charging.

3. What's the maximum flight time of GHOSTDRONE 2.0?

Flight time will vary depending on flight environment and flight mode. Under optimal condition, the maximum flight time for GHOSTDRONE 2.0 is 25 min. Please note that adding on gimbal, camera or other accessories will decrease the flight time.

4. How far and high can the GHOSTDRONE 2.0 fly?

The effective communication distance depends on the flight environment.

Under optimal conditions, GHOSTDRONE 2.0 can fly up to 1000 m (3,280 ft.) away from the mobile device and VR Goggles.

5. Are gimbals of GHOSTDRONE 2.0 Aerial and Aerial+ compatible with other sports camera?

GHOSTDRONE 2.0 Aerial's 3-axis gimbal is compatible with EHang sports camera, GoPro3, GoPro3+ and GoPro4.

6. Can the propeller guards and landing gears be used at the same time?

Yes. Propeller guards must be installed when flying indoors. If users fly GHOSTDRONE without propeller guards, EHang shall not bear any liability or responsibility for any accident arisen from this reason.

7. Does GHOSTDRONE 2.0 have obstacle avoidance?

Obstacle avoidance function is currently unavailable for GHOSTDRONE 2.0. Please beware of the flight environment and it is highly recommended to fly the aircraft in an open area.

8. Can I modify the GHOSTDRONE 2.0?

It is strongly not recommended to modify GHOSTDRONE 2.0 for the sake of safety. Please use EHang accessories only as well as reading through the manuals or consulting EHang's customer service staff. EHang is not responsible for any damages or loss caused by unsupervised modification or mounting on GHOSTDRONE 2.0.

9. Can GHOSTDRONE 2.0 Aerial be upgraded by adding gimbals or other accessories?

Yes. GHOSTDRONE 2.0 Aerial can be upgraded to GHOSTDRONE 2.0 VR by adding the 3D gimbal and VR goggles.

10. Can the VR goggles be used on other devices? Can the VR goggles be used with EHang FPV monitor at the same time?

VR goggles real-time image transmission relies on the 5.8G analog signals, thus it can also be used with any similar transmitter.

While using the VR goggles, FPV monitor can also be used to search for the same channel to watch the same images. But only the VR goggles can offer the head tracking function.

App

11. Why i am not able to discover bluetooth or Wi-Fi's name?

Please restart the VR goggles and reinitiate VR goggles search in App.

12. What will happen if the smartphone runs out of battery during flight?

If the copter does not receive any command in 5 seconds or lost communication, in the case of accurate GPS, it will automatically return. (battery life should be sufficient.); In the case of inaccurate GPS, it will land automatically.

Troubleshooting

13. Battery has been plugged in, VR goggles have been connected with the App, but the aircraft does not response. What should I do?

Please check if the Bluetooth / Wi-Fi has been connected successfully (Bluetooth / Wi-Fi icon lights on). Check if all statistics including satellite number, heartbeat and battery life are all displayed normally on the App interface. If nothing above is abnormal, please turn off all devices and restart the App, then try to connect again.

14. What should I do if I click unlock but the propeller don't work?

Solution 1: Please check if battery has been turned on. Then check if the Bluetooth / Wi-Fi has been connected successfully (Bluetooth / Wi-Fi icon lights on). Check if all statistics including satellite number, heartbeat and battery life are all displayed normally. If nothing above is abnormal, please turn off all devices and restart the App, then try to connect again.

Solution 2: If the copter's front indicator light constantly flashes red, wait for a while. If the front indicator light still flashes red and the copter can not be unlocked, please turn off all devices and restart the App, then connect again.

Solution 3: If solution 1 and 2 do not solve the problem, try to reinstall the EHang Play App and connect VR Goggles again.

15. What should I do if there is no response after choosing Companion Mode?

Please make sure you allow the EHang Play App to access your GPS location of your cellphone otherwise the Companion Mode can not be activated.

EHANG

www.ehang.com