

Flywoo

Firefly hex nano Manual

Analog BF Version



1/ drone introduction

In an effort to push the boundaries of carry the camera on the smallest platform, Flywoo designed the smallest hexacopter possible in their history.

Firefly Hex nano , a nano- sized fpv drone designed to carry Insta 360go , SMO 4K camera for some action flying.

Weighing in at just 57.9g , the Firefly hex nano is small , flexible, stable , but is full of power and offers unmatched control . Pilots can quietly enjoy the fun of shooting a video without jelly.

The Hex nao is equipped with GOKU HEX 13A STACK and 6pcs ROBO 1202.5 5500KV motors, to bring the Firefly a quiet, stable, flexible and long flight time characteristics.

Perfect for the indoor and outdoor recording every beautiful flying moment!



Battery recommend

Flight time:

About 6 min flight with Explorer 450mAh 4S battery

About 4 min flight with Explorer 300mAh 4S battery



2/ Configuration and wiring diagram description

Specifications

Item: Firefly hex nano hexacopter

Weight: 57.9g (without battery)

Wheelbase: 90mm

FC & ESC : GOKU HEX F4 16*16 STACK - (FC+13A ESC)

Frame: Firefly hex nano Frame

Motors: Robo 1202.5 5500KV

Props: HQ 40mm 4-Blades Props

Receiver Option: Frsky XM+ / TBS Crossfire

Camera Degree: 15°-90°

VTX: Goku VTX625 450mw

Antenna: Atomic 5.8GHz Antenna Length 30mm (RHCP)

Battery: 4S 450mAh / 4S 300mAh battery (Not including)

GOKU HEX F411 16X16 STACK, support 4s battery. Use powerful STM32F411 chip,5V/2A BEC, black box, WS2812LED, support 2 complete uarts, 1 soft serial port, 1 I2C port and other functions are all open! Enough to meet all FPV needs.

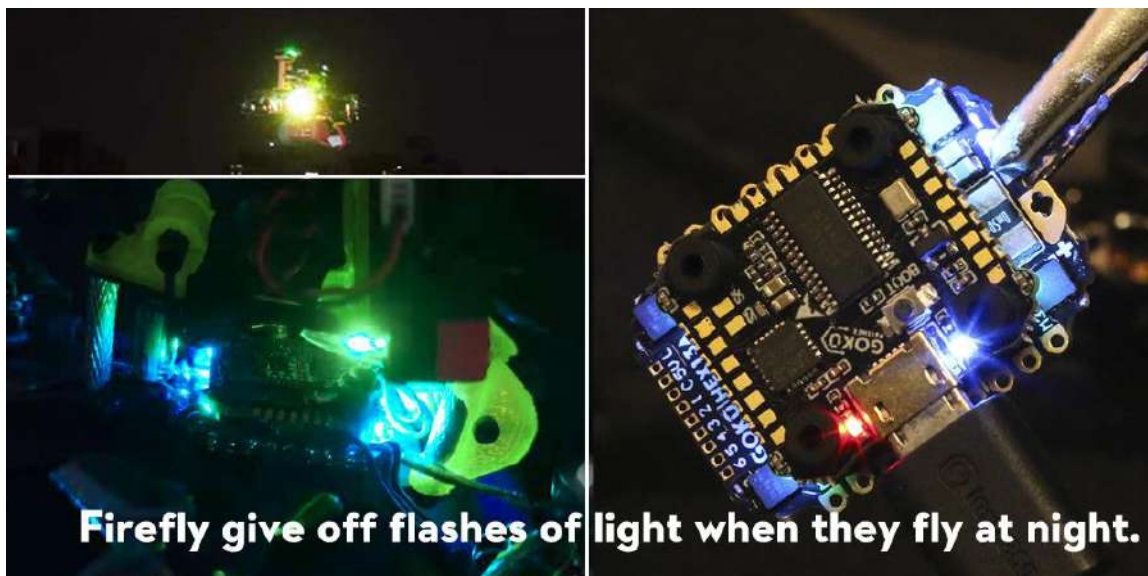

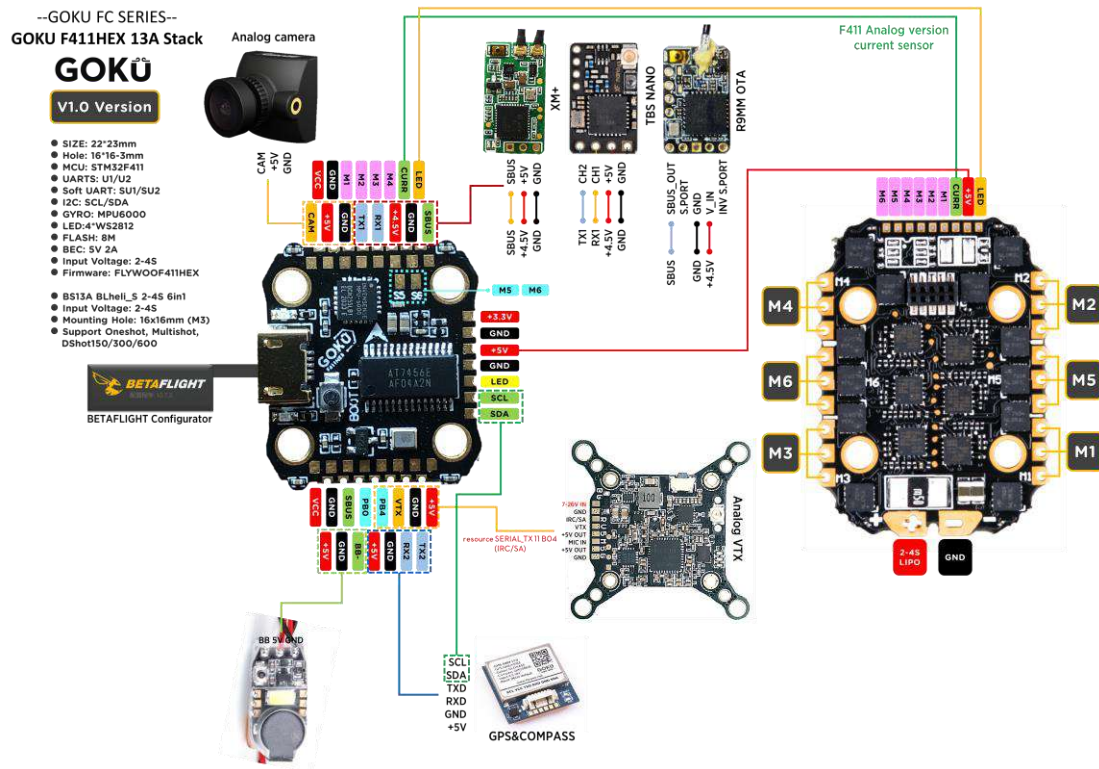

Target firmware: FLYWOOF411HEX

Identifier	Configuration/MSP	Serial Rx	Telemetry Output	Sensor Input	Peripherals
USB VCP	<input checked="" type="checkbox"/> 115200 ▾	<input type="checkbox"/>	Disabled ▾ AUTO ▾	Disabled ▾ AUTO ▾	Disabled ▾ AUTO ▾
UART1	<input type="checkbox"/> 115200 ▾	<input checked="" type="checkbox"/>	Disabled ▾ AUTO ▾	Disabled ▾ AUTO ▾	Disabled ▾ AUTO ▾
UART2	<input type="checkbox"/> 115200 ▾	<input type="checkbox"/>	Disabled ▾ AUTO ▾	Disabled ▾ AUTO ▾	VTX (IRC Tran ▾ AUTO ▾
SOFTSERIAL1	<input type="checkbox"/> 115200 ▾	<input type="checkbox"/>	Disabled ▾ AUTO ▾	Disabled ▾ AUTO ▾	Disabled ▾ AUTO ▾

UART1: TBS/R9M/XM+/DSMX/SBUS receiver

UART2: VTX IRC/SA Control

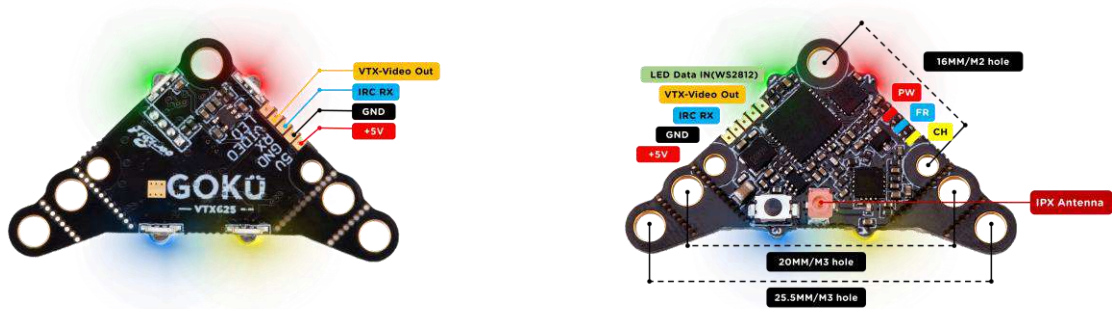

Frequency table :

FR/CH	CH1	CH2	CH3	CH4	CH5	CH6	CH7	CH8
A	5865	5845	5825	5805	5785	5765	5745	5725
b	5733	5752	5771	5790	5809	5828	5847	5866
E	5705	5685	5665	5645	5885	5905	5925	5945
F	5740	5760	5780	5800	5820	5840	5860	5880
r	5658	5695	5732	5769	5806	5843	5880	5917

- The selections in **xxxx** requires HAM license to operate .legally. **xxxx** Selections are only available on special request.
- **Button function**
- FR (blue light), short press the button, the blue light flashing times represent CH1-CH8
- CH (yellow light), long press the button 2S until the yellow light flashes, and then press the button shortly, the number of flashes of the yellow light represents A-r
- PW (power), long press the button 6S until the red light flashes, and then press the button shortly, the number of flashes of the red light represents 5 levels of power
- Long press 10S to unlock 40 channels. (three color led flashes)
- **Betaflight osd IRC function**

FLYWOO_GOKU_VTX625_VTXTABLE.json

<https://flywoo.net/pages/manual>

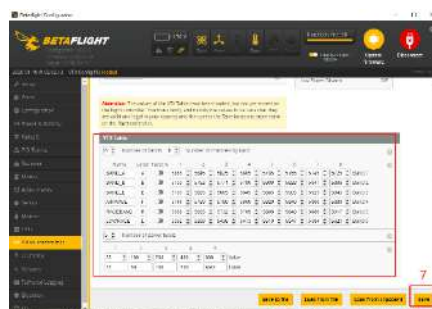
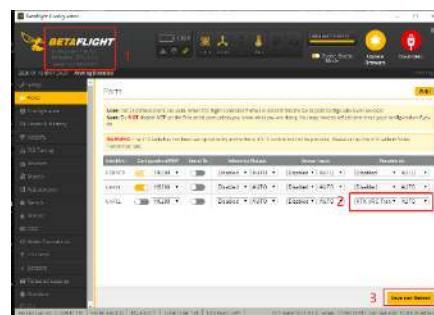
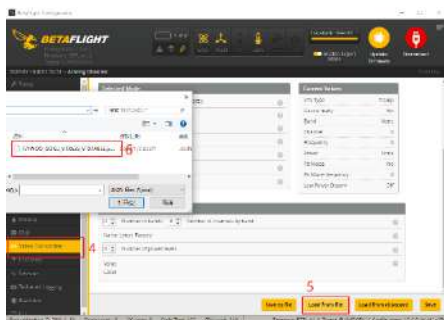

3/ Receiver binding

TBS NANO 915:

When the USB is connected, the green light of the receiver flashes, and then bind according to the picture operation.

https://www.youtube.com/watch?v=-iNKVcOLITM&ab_channel=Danimal3D



R9MM FCC ACCESS OTA:

Make sure your remote control supports ACCESS protocol, then follow the link to register and bind

https://www.youtube.com/watch?v=az5hDdNBcjg&t=9s&ab_channel=FrSkyRC

If the remote control is ACCST protocol, please bind as follows:

1/ Put these two files into the firmware directory of the SD card of the remote control.

R9MM firmware: FW-R9MM-ACCST_v20190201

R9M TX module: FW-R9M-ACCST-20190117

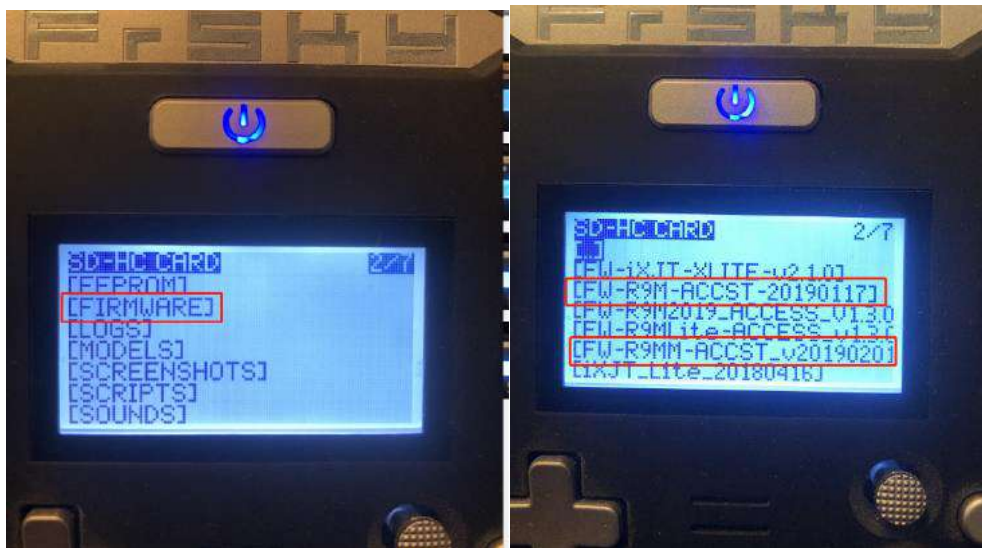

2/ Insert the R9M TX module and write the firmware you need

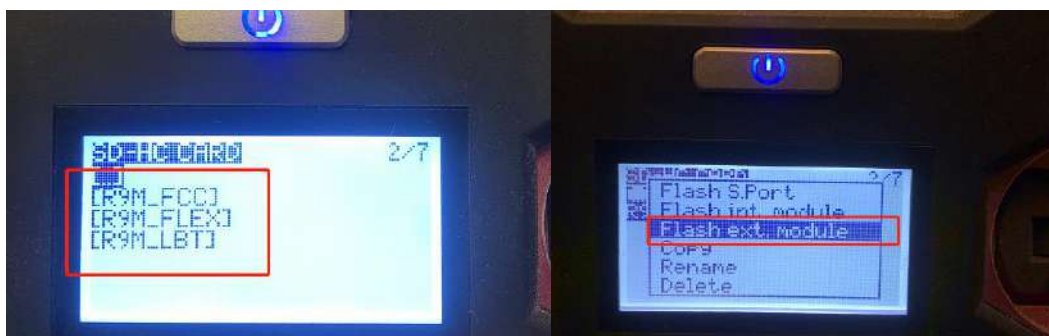

3/ To write the firmware of the R9MM receiver, you need to remove the R9MM receiver, and then write the firmware by connecting to the S.PORT port.



4/ After both R9M TX and R9MM RX are written into the ACCST firmware.

Binding method:

- 1/ Press and hold the button of RX, power on, the red and green lights are always on.
- 2/ Then after R9MM selects binding, RX red light flashes, and then exit
- 3/ RX is powered on again, and only a green light is displayed, indicating that the binding is successful.

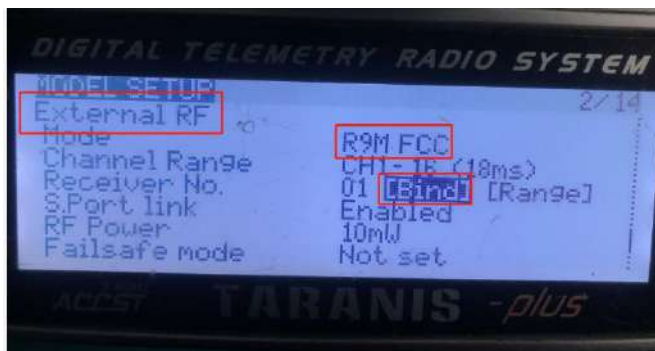

XM+ receiver:

- 1/ Press the XM+ receiver button, USB power supply, the red and green lights are always on
- 2/ The remote control turns on the binding mode, the green light flashes to indicate successful binding, turn off and restart



3-1/ Then set the corresponding serial port and receiver protocol to ensure the normal output of each channel of the receiver.

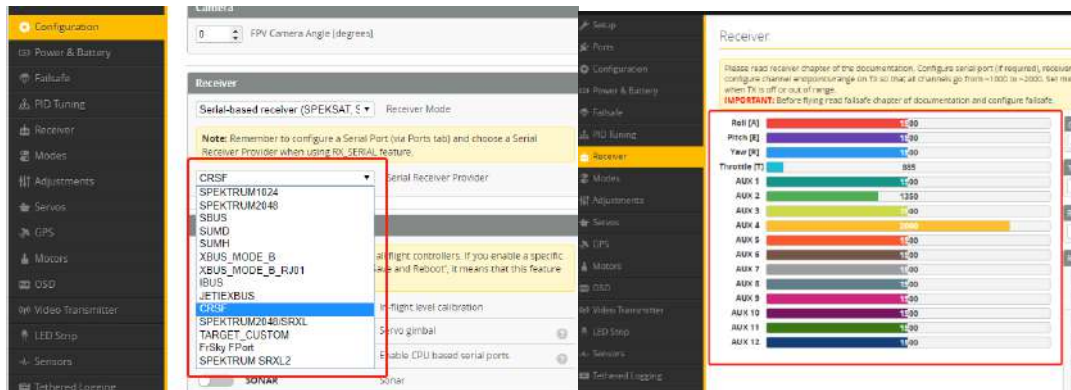

4/ Mode setting:

Set the ARM switch and flight mode switch, AUX* corresponds to the remote control switch, and the yellow area mark is turned on.

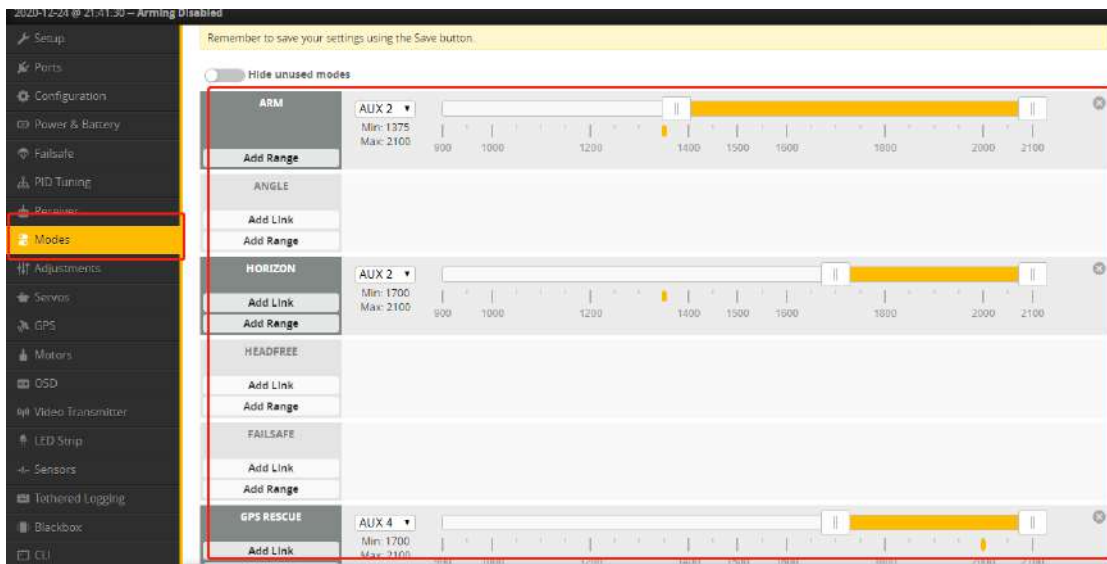

5/ Motor test:

Unload the propeller, test the rotation direction of the motor, turn on the safety switch, and test the rotation of the motors one by one.

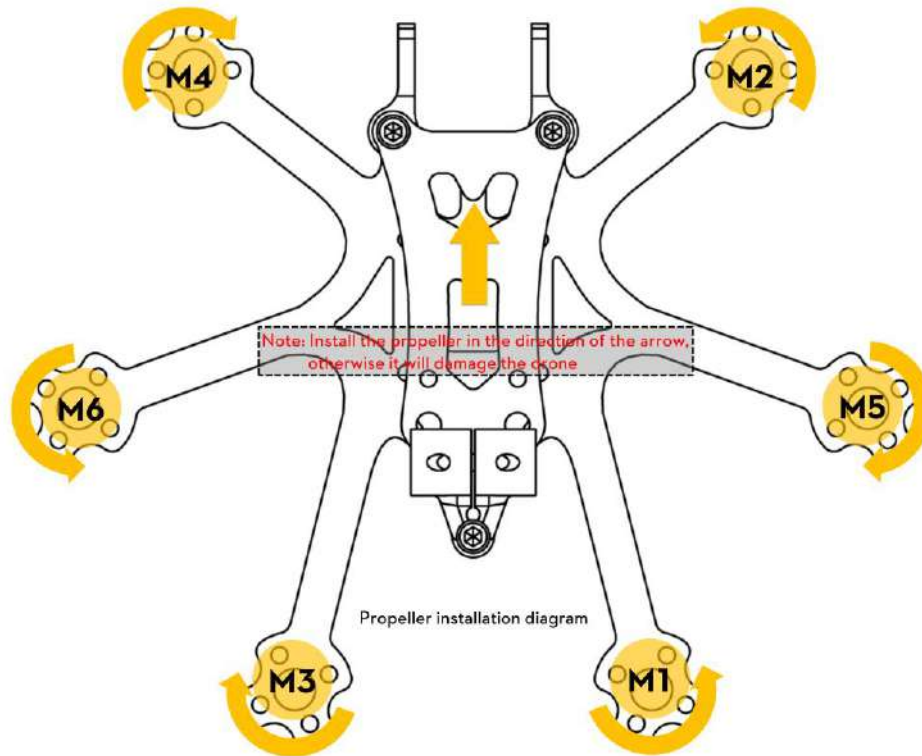

6/ Flight firmware upgrade and write default CLI

1/ Activate DFU mode

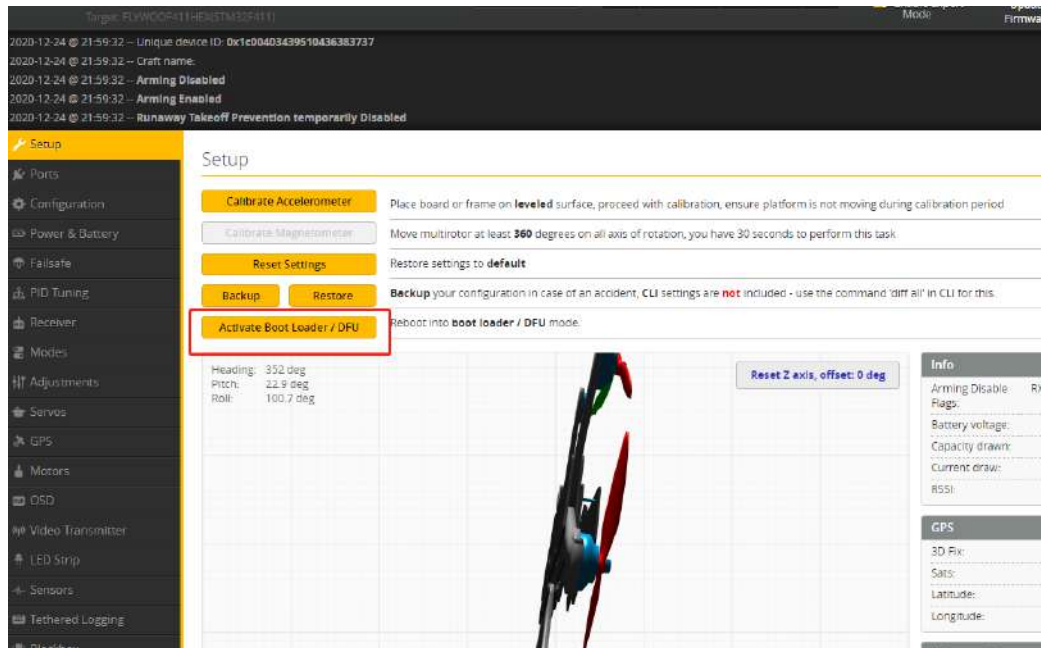

2/ BF Configurator will display to enter DFU mode. If it does not enter DFU mode, it may be that the driver is not installed. The driver can be installed using IMPULSE RC software

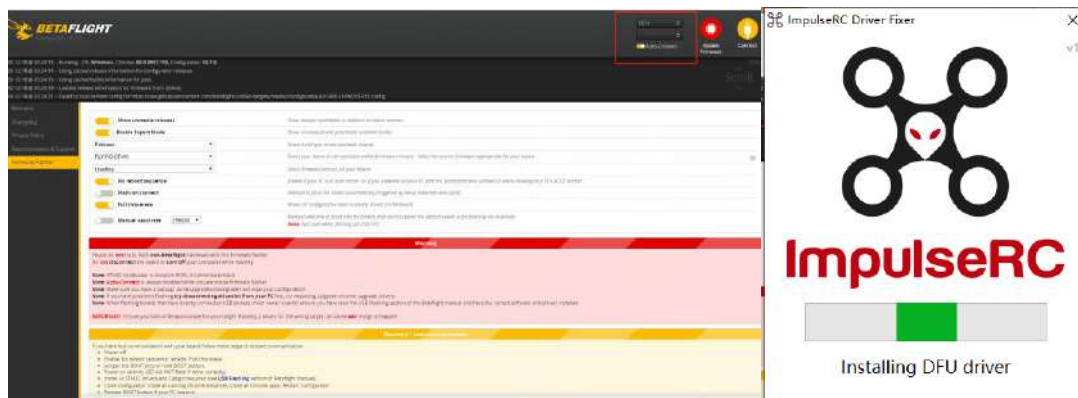

Driver software:

https://impulserc.blob.core.windows.net/utilities/ImpulseRC_Driver_Fixer.exe

3/ Then load the local HEX firmware and wait for the flashing to complete. A green progress bar is displayed to indicate completion, and DFU will become a COM port

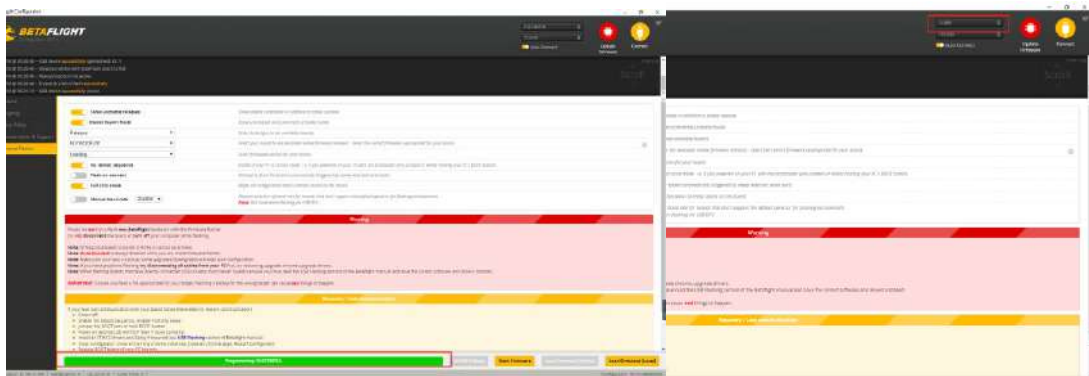
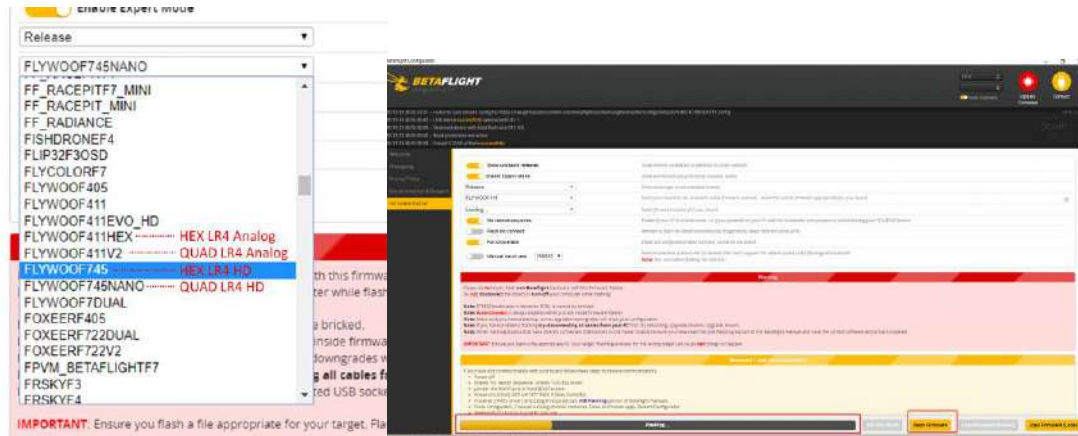

4/ After the connection is entered, it is a blank interface, you need to write CLI commands, Factory CLI LINK: <https://flywoo.net/pages/manual>

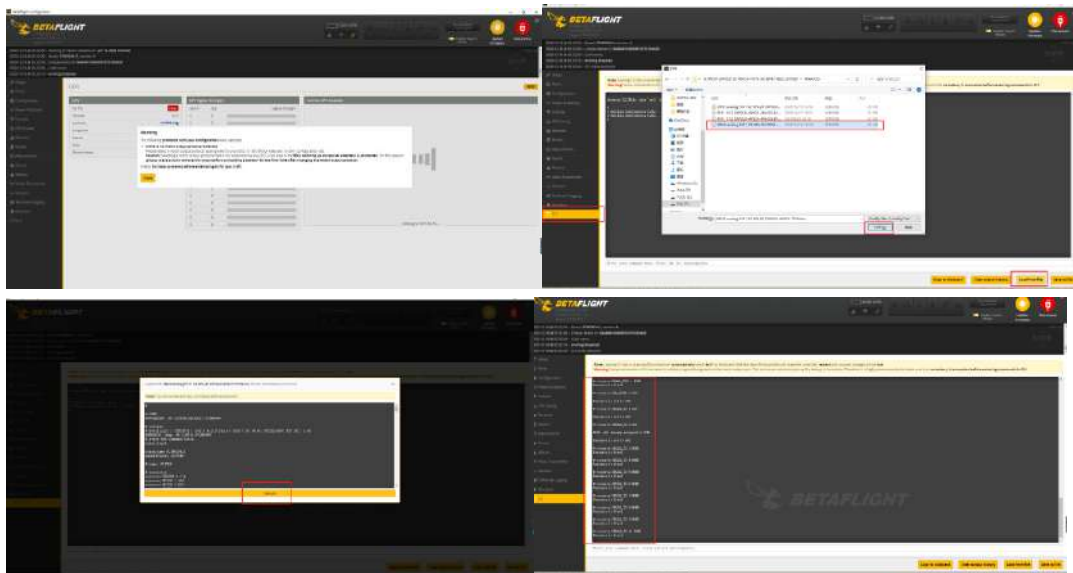

5/ If the command is not restarted after writing the command, please write SAVE and press Enter to save, and the FC will restart

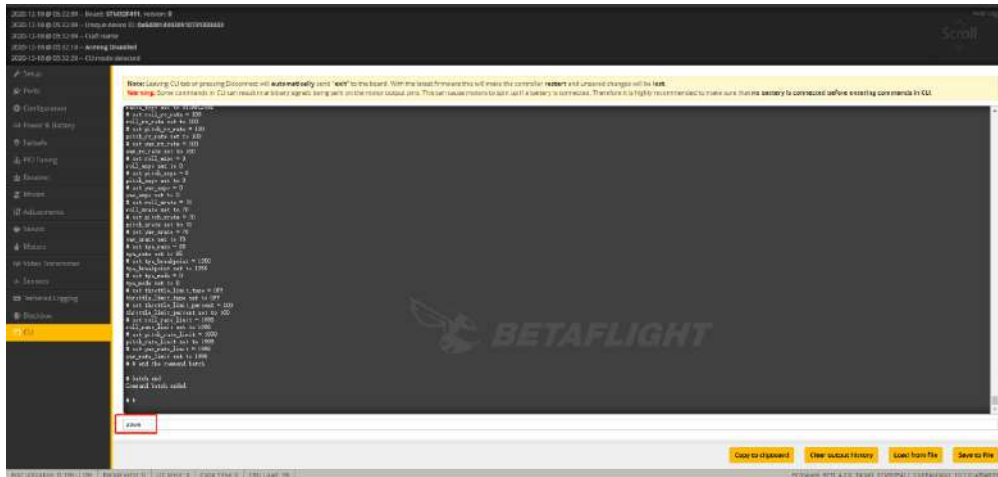

6/ Then all functions of FC return to normal.

