

SKY HAWKEYE

Quadcopter AEROCRAFT

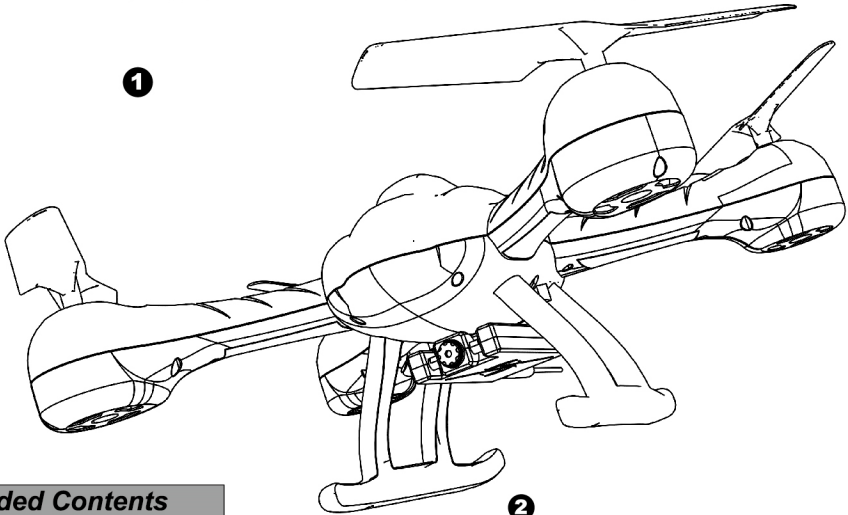

1



Included Contents

- | | |
|---|------------------------|
| 1 | SKY HAWKEYE |
| 2 | Remote Transmitter |
| 3 | USB Cable for Charging |
| 4 | 3.7V Lithium Battery |
| 5 | RAM card |

2

LCD Screen Instructicon:
AVI: Play the recorded video.
REC: Press this button to record a viedo when flying.
SNAP: Press this button to take a picture when flying.
JPG: Display pictures.
SET: Detail settings.

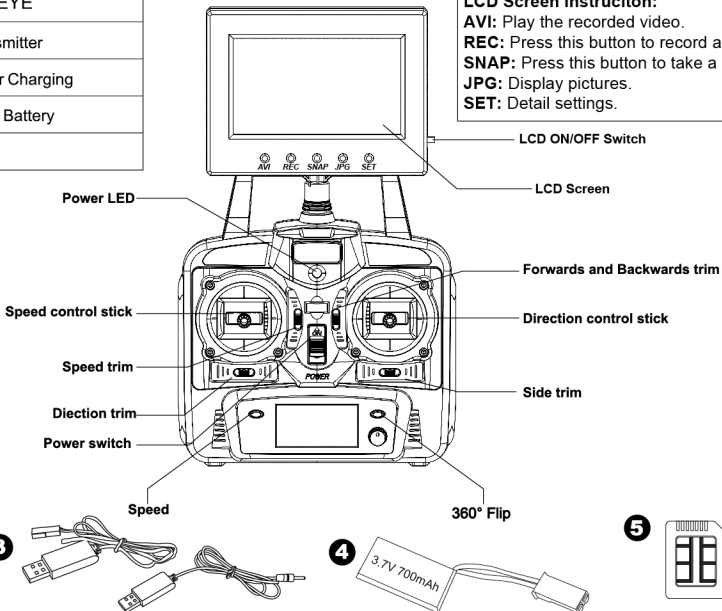

3



4



5



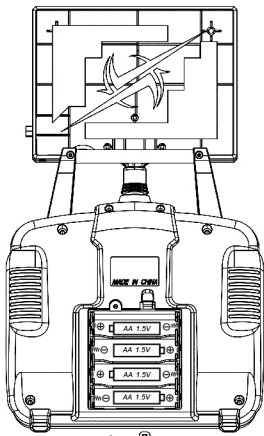

Please use 4 AA sized batteries, installed based on polarity indicated. Please do not mix batteries of different types.

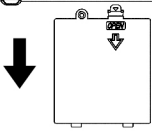
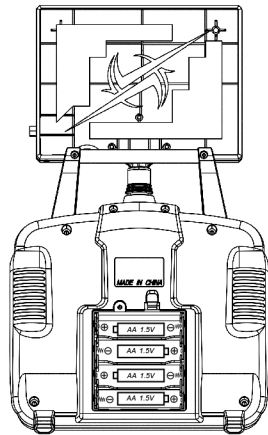
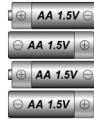

Slide the battery lid to open by following the arrow.

Battery lid

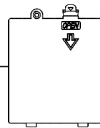

CAUTION
If transmitter is not to be used for a long duration, please remove batteries for storage.



WARNING:
Warning: If the AA batteries are left in the transmitter, potential leakage could occur which may damage the transmitter, and create fire hazards.

The product battery refresh

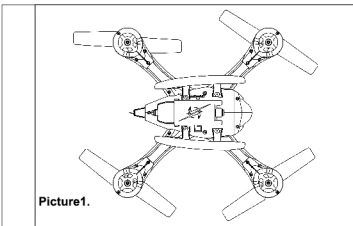

Picture1.

Step1

Carefully Disconnect the Battery wires from the battery also note that battery might be hot if removing after use, in this case wait a few minutes before charging again.

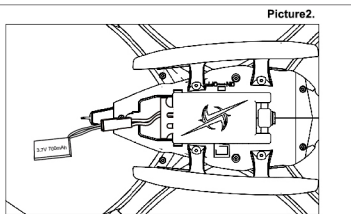

Picture2.

Step2

Very Carefully remove battery from slot as pictured being careful not to pull battery by the wires otherwise you could disconnect or break one of the wires (As Picture2).

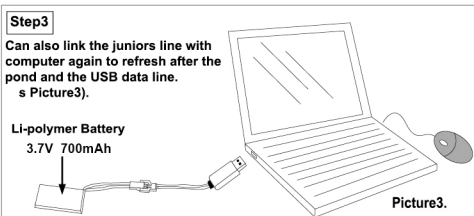

Step3

Can also link the juniors line with computer again to refresh after the pond and the USB data line. s Picture3).

Li-polymer Battery
3.7V 700mAh

Picture3.



When charging thru the included USB cable: LED light is red indicating it is charging LED light is out indicating charging is done

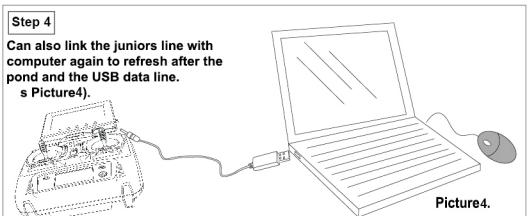

Step 4

Can also link the juniors line with computer again to refresh after the pond and the USB data line. s Picture4).

Picture4.

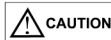

When charging thru the included USB cable: LED light is red indicating it is charging LED light is out indicating charging is done

ENVIRONMENT FOR FLIGHT

1.If using outside please fly on a sunny day, without wind if possible Flying in extreme heat and/of cold will affect flying control.

2.Lay the Skyflyer on the ground after connecting the battery. Please wait for the Digital Gyro to take 5-7 seconds to electronically stabilize. Push the throttle up and then back down to connect the remote to the Sky Flyer the lights should stop blinking and you are now set to fly!

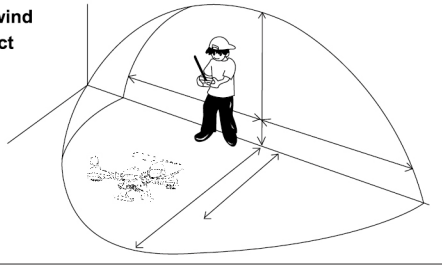

WARNING

Suitable for Children 14+. Adult supervision is always recommended.

*This product contains small parts which are a choking hazard. Keep away from small children.

*Keep Quadcopter at least 10 feet away during use.

*Correctly install the Quadcopter and fly it under the guidelines of the instruction manual, small parts should be assembled by an adult.

*Manufacturers and dealers disclaim all responsibility for damage caused by misuse.

*Keep hands, hair, and loose clothing away from rotors when powered on to prevent damage to the helicopter or serious injury to self

*This QUAD should not be flown IN HIGH WINDS(5+Mph) or near a pool.

***Never leave a charging battery unattended.**

TECHNICAL PARAMETERS

Length: 280mm

Width: 280mm

Height: 100mm

Charging Time: 60 minutes

Flying Time: Above 5 minutes

Remote controlled distance:>50m

START PREPARATION

The thrust controller (the left controller on the remote control) must point down before being switched on. Then move the ON/OFF switch on the remote control to "ON " and the Power LED will begin to blink. Connect the battery cable using the connection cable. The LED on the quadcopter now starts to blink. Place the quadcopter on the ground so that the tail points toward you with the two red propellers in the rear. The quadcopter needs around 5-10 seconds to initialise the gyro and to establish the connection to the remote control. As soon as the LED on the quadcopter lights up green permanently, the connection for the remote control has been established.

Warning! Be sure to place the quadcopter on a level surface-the control electronics aligns its neutral position to the surface!

TRIM ADJUSTMENT OF THE CONTROL

The correct trim is a basic requirement for fault-free flying behavior of the quadcopter.

Its adjustment is simple, but it requires some patience and a feel for it.

please observe the following instructions precisely: Carefully move the thrust control up and raise the quadcopter approximately 0.5 to 1 metre in altitude.

If the quadcopter moves by itself slowly or quickly to the left or right.....

Press the trim control for rotation incrementally in the opposite direction.

If the quadcopter moves by itself slowly or quickly around its own axis.....

Press the trim control for rotation incrementally in the opposite direction.

If the quadcopter moves by itself slowly or quickly forwards or backwards.....

Press the trim control for forward and backwards flight incrementally in the opposite direction.

CONTROL METHOD

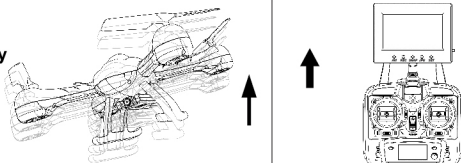
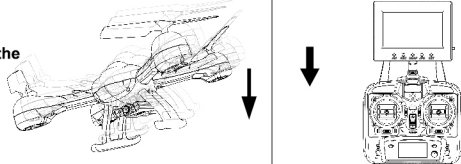
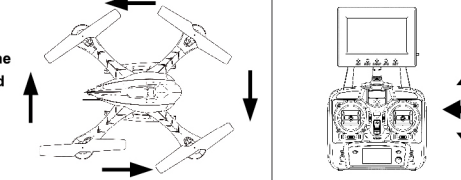
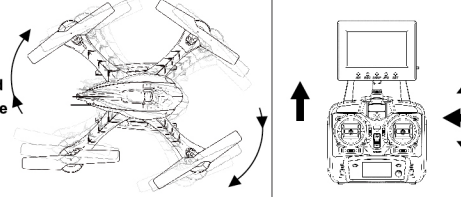
<p>Ascend</p>	<p>Take the left throttle stick and gradually raise it in the upward direction to desired altitude.</p>	
<p>Descend</p>	<p>Take the left throttle stick and lower it in the downward direction to decrease altitude and stop propellers from moving.</p>	
<p>360 Degree Maneuver</p>	<p>To alter the direction in which it flies, take the left throttle stick and move it to the right and left and it will change direction.</p>	
<p>Steering</p>	<p>Take the right throttle stick and either raise it upward to go forward, lower it downward to go backwards, move it left to sway to the left, move it right to sway to the right.</p>	

PROBLEMS AND SOLUTIONS

Problem	Reason	Problem shooting
<p>No power with the transmitter</p>	<p>1. Pull to the "OFF" position on the ON/OFF button.</p>	<p>1. Pull to the "ON" position on the ON/OFF button.</p>
	<p>2. Do not correctly load the batteries as per the correct polarity shown.</p>	<p>2. Check and make sure the batteries are correctly loaded as per the polarity shown in the battery box.</p>
	<p>3. The battery is exhausted.</p>	<p>3. Replace with the new battery.</p>
<p>Can not control</p>	<p>1. Transmitter is not opened.</p>	<p>1. Pull to "ON" position on the ON/OFF button of the transmitter.</p>
	<p>2. The aircraft battery no connection.</p>	<p>2. The aircraft battery in the correct orientation connection.</p>
	<p>3. Too strong wind force.</p>	<p>3. Do not fly under the environment of windy as too strong wind may cause flying limitation the aircraft or it may hamper your controlling or flying.</p>
	<p>4. Code pairing fails.</p>	<p>4. Retry the code pairing.</p>
<p>Ascending failure</p>	<p>1. The rotating speed of the rotor is too slow.</p>	<p>1. Push the power controlling lever upward.</p>
	<p>2. Battery electric quantity of aircraft is insufficient.</p>	<p>2. Charge the battery of aircraft or renew battery.</p>
<p>Landing too soon</p>	<p>The throttle stick is pulled down too fast.</p>	<p>Pull down the throttle stick slowly to perform a smooth landing.</p>

MADE IN CHINA

