

ZINO MINI SE

《 User Manual 》

V2.0

DISCLAIMER & WARNING

All users must read product operating instructions and liability disclaimer before using and operating any HUBSAN products. By using a HUBSAN product(s), users accept the terms and conditions of HUBSAN liability and operational guidelines. This product is not suitable for minors under 14 years of age. When operating a HUBSAN product(s), users also accept all liability and responsibility for their own behavior, actions as well as any consequences resulting thereof while using a HUBSAN product(s). These products may only be used for purposes that are in accordance with local laws and regulations, and any applicable policies / guidelines HUBSAN may make available. Users agree to comply with these terms and conditions, along with any and all relevant policies / guidelines set forth by HUBSAN. Part of the details of this document may change with the upgrade of the product software version. Please read the upgrade details carefully before upgrading the software version.

INSTRUCTIONS

Some of the product flight functions are restricted in certain areas. Once you use this product, you must strictly read and follow the relevant ICAO regulations, local airspace and UAV regulations. You are liable for any non-compliance with the foregoing, and are responsible for the consequences of your actions as well as any indirect and / or direct liability that arises as a result of these limitations.

FLIGHT ENVIRONMENT REQUIREMENTS

- (1) Select an open area to fly. Avoid high rise buildings and tall obstacles (such as trees and poles). Near buildings and obstacles, flight control signals and GPS signals are severely affected; GPS functions such as GPS mode and Return to Home may not function properly.
- (2) Do not fly in bad weather conditions (such as in wind, rain or fog).
- (3) Fly the aircraft in ambient temperatures of 0-40 °C.
- (4) When flying, please stay away from obstacles, people and crowds, high voltage lines, trees, water, etc.
- (5) To avoid remote control signal interference, do not fly in strong electromagnetic environment (such as venues with radio stations, power plants and Phone antenna and TV towers).
- (6) The aircraft cannot be used at or near the Arctic circle or Antarctica.
- (7) Do not fly in no-fly zones.
- (8) Do not operate the aircraft near high pressure lines, airports or areas with severe magnetic interference.

IMPORTANT SAFETY INFORMATION

OPERATION

Be extremely cautious and responsible when using the aircraft. Small electronic components can be damaged due to crashes or exposure to moisture / liquid. To avoid any injuries, do not use the aircraft with damaged components.

MAINTENANCE

Do not try to open or repair the units by yourself. Contact HUBSAN or HUBSAN authorized dealers for service. For more information, please visit the official website at www.hubsan.com

BATTERY

Do not disassemble, squeeze, impact, burn, drop or trample the battery. Do not short-circuit or put the battery terminal in contact with metal. Do not expose the battery to temperatures above 60 ° C. Fully Charge the aircraft battery prior to flight. Use only HUBSAN dedicated supplied charger for charging. Keep the battery out of the reach of children and away from any kind of moisture.

FLIGHT

Please be mindful of personal safety and the safety of others when operating and flying your drone.

- Do not fly in bad weather conditions.
- Do not attempt to catch the aircraft while it is in flight.
- This product is intended for experienced pilots over the age of 14.
- After every flight, completely disarm the aircraft motors and power off the drone. Then, power off the remote control.

READ THE DISCLAIMER AND SAFETY GUIDELINES FIRST BEFORE USE.

Symbol Explanation:

 Prohibited Operation

 Instruction

 Important Notice

 Explanation / Reference

HUBSAN Safety Notice for Intelligent battery

- If you do not plan to use the product for a long period of time, make sure to charge the battery to more than 7.4v. if the voltage is higher than 7.4v and the battery button is not pressed two days later , the battery will automatically discharge to 7.4v. Maintaining and storing the battery with about 7.4v can increase battery life.
- Please use only HUBSAN chargers or HUBSAN Charging Hub for battery charging.
- Discharge the battery at 5C current or below. To avoid discharge related battery damage, do not discharge for longer period of time than advised.
- Do not charge in a flammable and explosive environment to prevent fire.
- Batteries need to be recharged if unused for over 3 months.

- ⊗ 1. Do not disassemble or reassemble the battery.
2. Do not short-circuit the battery.
3. Do not use or charge near sources of heat.
4. Do not put the battery in contact with water or any kind of liquid.
5. Do not charge batteries under sunlight or near fire.
6. Do not puncture or subject the battery to force of any kind.
7. Do not discard unused batteries to regular trash.
8. Never charge a battery that has been damaged, become deformed or swollen.
9. Do not solder on or near the battery.
10. Do not reverse charge or over discharge the battery.
11. Do not reverse charge or reverse the battery polarities.
12. Do not connect the battery to a car charger / cigarette lighter or any kind of unconventional power source.
13. This battery is prohibited to use with non-designated devices.
14. Do not mix other types of batteries with lithium batteries.
15. Do not exceed the specified charging time.
16. Do not place the battery in a microwave or in areas of high pressure.
17. Do not expose the battery to the sun or excessive heat.
18. Do not fly in places with strong interference (high-voltage line, power stations, base stations, high-speed rail lines, signal towers, etc.)
19. Do not use or charge in temperatures below 0 °C and above 45 °C.
20. If a newly purchased battery showing, leaks, possesses a bad smell or other abnormalities, contact and return the battery immediately to the vendor.
21. Keep away from the reach of children.
22. Use a dedicated battery charger only and follow all charging guidelines.
23. Adults must supervise minors, if allowed to charge the batteries even when using dedicated HUBSAN chargers.

Contents

Disclaimer

Important safety information

Battery use precautions

1 Aircraft

1.1 Aircraft Spare Part 1

1.2 Aircraft Battery 3

1.2.1 Aircraft Battery Charging 3

1.2.2 Aircraft Battery Installation 4

1.2.3 Intelligent Battery Functions 4

1.2.4 Precautions For Low
Temperature 5

1.2.5 Precautions For Battery 6

1.3 Propellers 6

2 Remote Controller(America Mode 2)

2.1 Remote Controller Components 7

2.2 Remote Controller Features 8

2.3 Charging The Transmitter Battery 9

2.4 Remote Control Diagram 10

2.5 Remote Control Antenna Angle 11

2.6 Transmitter Calibration 11

3 Flight

3.1 Download The X-HUBSAN 2.0 APP 12

3.2 Main Interface Guide 12

3.3 Pairing The Aircraft 13

3.4 Aircraft Calibration 15

3.4.1 Horizontal Calibration 15

3.4.2 Compass Calibration 15

3.5 Staring / stopping The Motors 16

4 Aircraft Functions

4.1 Flight Control Mode 17

4.2 Aircraft Indicator 18

4.3 Return-to-home(Rth) 18

4.4 Landing Apron Search 20

4.5 Optical Flow Vision System 21

4.6 Flight Mode 22

4.6.1 Creative Video 22

4.6.2 Orbiting 23

4.6.3 Waypoint 23

4.6.4 Line Fly Mode 24

4.6.5 Follow Mode 24

4.6.6 Hyperlapse 25

4.6.7 Panorama mode 26

4.7 Gimbal Pitch Axis

Adjustment 27

4.7.1 TF Card 28

FAQ

Limitation Of Liability

Fcc Information

1.Aircraft

1.1 Aircraft Spare Part

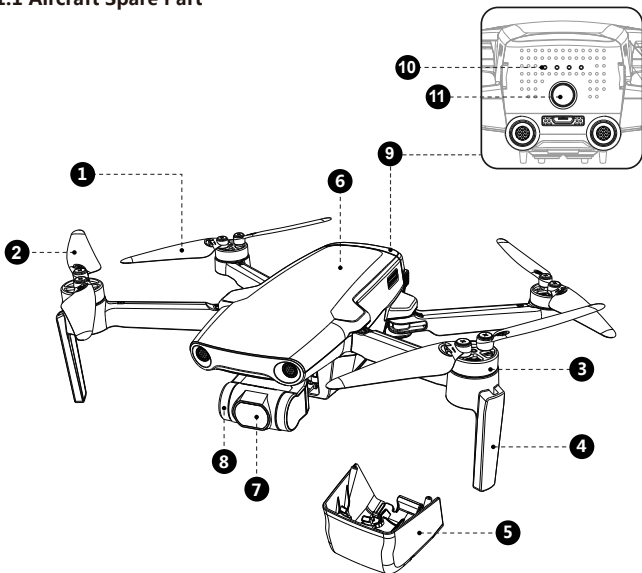

❶ Propeller A

❷ Propeller B

❸ Motor

❹ Tripod (With Antenna)

❺ Gimbal Protection Guard

❻ Body shell

❼ 4K HD Camera

❽ 3-axis gimbal

❾ Intelligent Battery

❿ Battery level indicator

⓫ Battery power switch

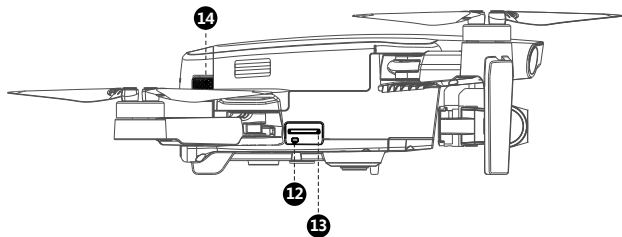

12 Bind button

13 TF Slot

14 Battery buckle

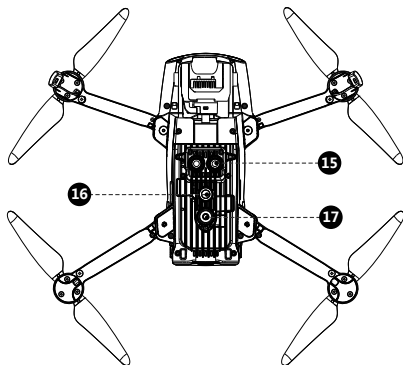

15 Low-altitude infrared altitude hold system

16 Downward Vision System

17 Aircraft flashlight



Note: The aircraft will generate heat when it is running, after the flight, please Avoid direct skin contact with the bottom heat sink and the metal motor housing.

1.2 Aircraft Battery

1.2.1 Aircraft Battery Charging

Aircraft Lithium Battery Capacity: 3000 mAh, 7.2V lithium 2S intelligent battery, the standard version does not come with a charger, so consumers can charge it through a normal 5v micro interface phone charger, and the charging time with a 9 V / 2 A charger is about 2.5 hours.

① With the intelligent flight battery off, plug the charging adapter into the intelligent battery connector.

② Connect the power adapter to AC power and then connect the adapter to the charging head with the MicroUSB cable.

③ Intelligent Battery Level indicator will flash and indicate the current battery level under charging.

④ If it is charged with the charging head, Intelligent Battery is fully charged when the charging head and the battery indicator lights are all solid.

If you are charging with Charge Manager, Intelligent Battery is fully charged when the Charge Manager lights are off and the battery indicator lights are solid.

⑤ Please make sure to charge the battery at an ambient temperature between 0-40°C.

Note: After using the battery, please recharge it full in time to maintain a good battery life.

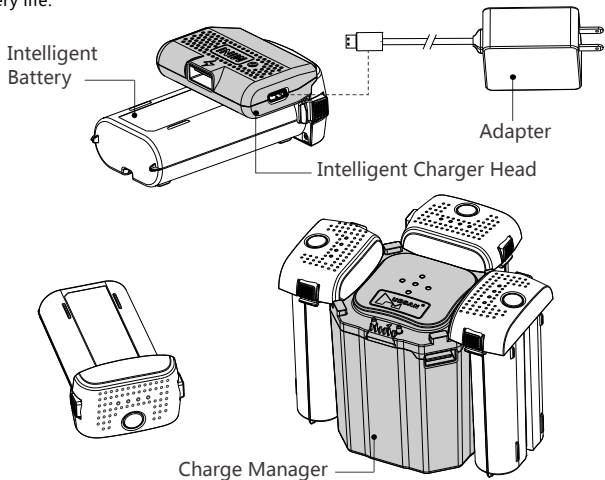

(Note: The adapter and charging manager are only available in the portable package version, not in the standard version.)

1.2.2 Aircraft Battery Installation

- 1 Take a fully charged battery
- 2 Insert the battery into battery compartment, while pressing the left and right edges behind of the battery (As shown in illustration) push in, until the battery buckles are fully locked. You should hear buckle locking sound
- 3 Battery top should be flush with aircraft back that confirms battery is in place.

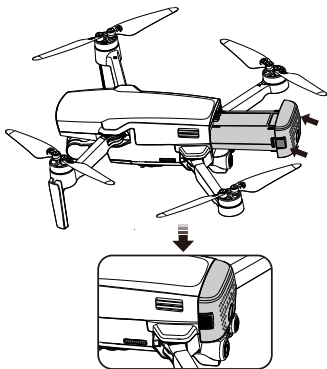

1.2.3 Intelligent Battery Functions

- (1) Power display: The battery has a power indicator, which can display the current battery power levels.
- (2) Auto-Discharging Function: To prevent swelling, the full battery automatically discharges to 7.4V to protect the battery, when it is idle for 2 days. (It is normal to feel moderate heat being emitted from the battery during the discharging process.)
- (3) Balanced Charging: During charging, the voltages of the battery cells are automatically balanced.
- (4) Overcurrent Protection: The battery stops charging if an excess current is detected.
- (5) Overcharge Protection: The battery stops charging automatically once fully charged.

(6) Over-discharge Protection: Discharging stops automatically to prevent excess discharge.

(7) Short Circuit Protection: The power supply is automatically cut if a short circuit is detected.

(8) Battery Cell Damage Protection: HUBSAN App displays a warning message when a damaged battery cell is detected.

(9) Communication: Information about the battery's voltage, capacity, and current is transmitted to the aircraft.

Battery switch	Short press to check the battery level, it will turn off after 3 seconds
	Short press first and then long press to turn on / off, the indicator light turns on / off

1.2.4 Precautions for Low Temperature

(1) If the battery is used in a low-temperature environment (-10°C to 5°C), please fully charge the battery and keep it warm (over 10°C.)

(2) Using the battery in an environment below -10 ° C may have unpredictable results.

(3) In a low-temperature environment, the actual discharge of the battery is likely to be different than the theoretical discharge capacity. It is recommended to stop flying and land immediately when the APP prompts a "low battery alarm".

(4) In a low-temperature environment, due to the limitation of battery output power, the wind resistance of the aircraft will be reduced. Please fly with caution.

1.2.5 Precautions For Battery

Be sure to fully charge each time before using the Intelligent Battery. Charge the intelligent battery only with Hubsan supplied power adapter and intelligent charging modules.

(1) After each flight, battery temperature maybe higher. Allow Intelligent Battery to cool down to normal room temperature before charging.

(2) The charging temperature range of the intelligent battery is 5°C to 40°C . If the temperature of the battery cell is not in this range, the battery management system will stop charging. The optimal charging temperature range is $25 \pm 3^{\circ}\text{C}$. Charging in this temperature range can extend the battery life.

(3) When charging or installing, please do not hot plug the battery, which may cause irreversible damage to the battery, so when pulling out or inserting the battery from the charging head, charge manager or drone, please make sure the battery is turned off properly.

1.3 Propellers

Before installing the propeller, please carefully check the letters by the aircraft motors and the letters on the propeller. You must match those letters when installing propellers; If the blade is damaged or needs to be replaced, unscrew the screw counter-clockwise to remove the propeller.

Be sure to replace the propeller together with the original new propeller screws to prevent accidental screw and propellers loss. (HUBSAN Standard accessories come with original screws)

HUBSAN brand new propeller screws 

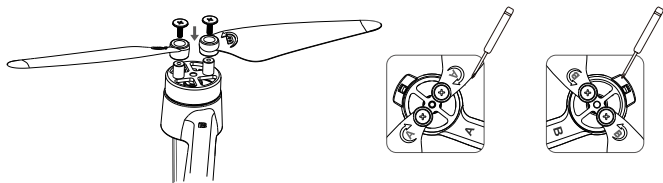

2. Remote Controller (America Mode 2)

2.1 Names Of Remote Controller Components

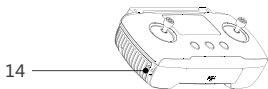
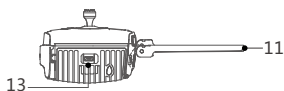
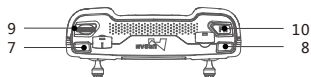
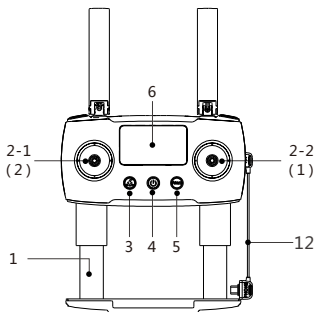

- 1) Smartphone / Device holder
- 2-1) Throttle / Rudder Stick
- 2-2) Forward / backward / left / right flight control levers
- 3) Return to Home
- 4) Power
- 5) F / N / S mode:
Movie mode / normal mode / sport mode
- 6) Display
- 7) Photo
- 8) Video
- 9) Gimbal Pitch Control dial
- 10) Custom button
- 11) Antenna
- 12) Remote control extension cable
- 13) Charging / Adapter Port
- 14) Lanyard hole of transmitter
- 15) Rocker storage slot
- 16) Cable storage slot

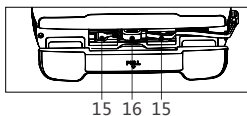

2.2 Remote Controller Features

S/N	Key / Switch	Function
(1)	Throttle / Rudder Stick (Mode 1)	Move the stick forward or backward to ascend or descend the drone. Move the stick left or right to rotate the drone Clockwise or counter clockwise.
(2)	Elevator / Aileron Stick (Mode 1)	Move the stick forward or backward to fly the drone forward or backward. Move the stick left or right to fly the drone left and right.
1	Throttle / Aileron Stick	Move the stick forward or backward to ascend or descend the drone. Move the stick left or right to fly the Drone left and right.
2	Elevator / Rudder Stick	Move the stick forward or backward to fly the drone forward or backward. Move the stick left or right to rotate the drone clockwise or counter clockwise.
3	Return to Home	Long press the button to activate Return to home mode. Remote control will beep every 3 seconds during return to home flight. Short press to cancel return to home.
4	Power Switch	Short Press, then press hold to power on or off
5	F / N / S mode (Movie / Normal / Sport mode)	Movie mode: Flying speed of the drone is limited to 3m/s Normal mode: The maximum speed of the flying machine set by APP Flight, maximum 10m/s Sport mode: the maximum flight speed of the aircraft 16m/s
6	Display	Displays the flight parameters
7	Photo	Short press to take photos.
8	Video	Long press to start recording video, Short press to stop recording video
9	Gimbal Pitch control dial	Controls the pitch angle of the gimbal.

S/N	Key / Switch	Function
10	Custom keys	<p>Long press the Fn+ wheel to adjust the zoom function. Press and hold the Photo+ wheel to adjust the brightness of the remote control screen.</p> <p>The remote control buzzer beeps when a low battery is triggered or Return to home is activated. Press the Fn button for 1.5 seconds, to stop beeping prompts.</p> <p>Long press the Fn button again 1.5 seconds to restart the beeping prompts.</p> <p>Custom keys, set the function on the APP and save it when the APP is not connected, [short press] Fn won't work.</p> <p>Function one: Exit the current flight mode.</p> <p>In this mode, short press Fn to exit the current flight mode and the aircraft will hover.</p> <p>Function two: short press Fn to execute gimbal return to normal state.</p> <p>Function three: no function (factory default function)</p>
11	Charging / Adapter Port	Charge the remote control or connect with a mobile device
12	Low Battery Warning	Low battery warning for the aircraft or remote control: Remote control "Beeps" once every second.
13	Standby Protection	If Remote controller is left on and unused, it will start beeping once every 3 seconds and switch to stand by mode. After 3 minutes of beeping, remote control will automatically shut down

2.3 Charging The Transmitter Battery

The remote is charged using the Micro USB cable as shown:

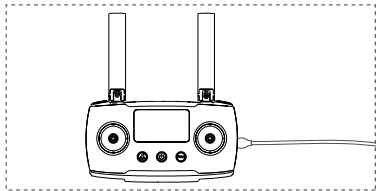

The remote control charging time is about 2.5 hours. The remote control battery indicator light flashes during charging. When charging is complete, the LEDs will stay on solid. The use time after fully charged is about 1.5 hours.

2.4 Remote Control Diagram

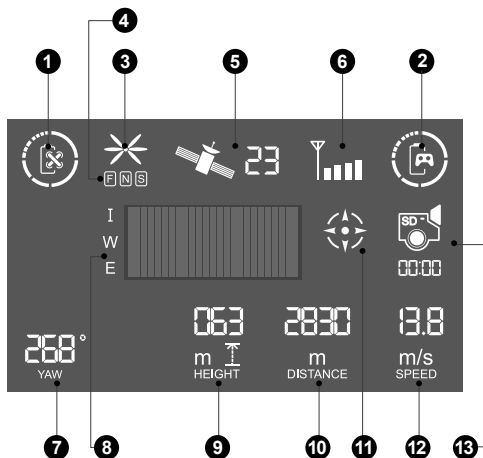

- | | |
|--------------------------|------------------------|
| 1 Aircraft Battery level | 8 Character Area |
| 2 RC Battery level | 9 Flight Height |
| 3 Propellers Status | 10 Flight Distance |
| 4 Aircraft Mode | 11 Compass Calibration |
| 5 Aircraft GPS Satellite | 12 Aircraft speed |
| 6 Aircraft Signals | 13 Photo / Video |
| 7 Heading Angle | |

2.5 Remote Control Antenna Angle

- (1) Adjust the angle of the remote control antenna and try to face the flight direction of the aircraft as much as possible.
- (2) Long-distance state, the distance between the two antennas is properly tightened to maintain the antenna directivity.
- (3) Closer State, the two antennas are properly separated to maintain a wide receiving range.
- (4) Do Not Form an occlusion or cross between the antennas.

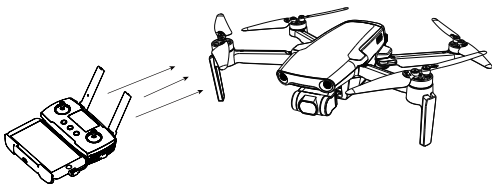

2.6 Transmitter Calibration

Start Calibration: Push and hold both sticks to the upper left corner as shown in picture below, and power on the transmitter, the transmitter will enter calibration state and start Beeping; release the power button and sticks.

Calibrate Sticks: Rotate both sticks in circles to their maximum travel for at least three times, and release the sticks

Exit and save calibration: long-press any button except the power button until the remote controller stops beeping and the screen lights on

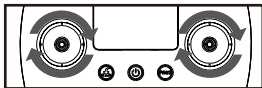
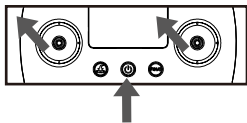

3 Flight

3.1 Download The X-HUBSAN 2.0 App

Before flying, download and install the X-HUBSAN 2.0 APP. Download the APP for free by scanning the code at right or search in APP Store (IOS) Or Goggle Play.



X-HUBSAN 2.0

3.2 Main Interface Guide

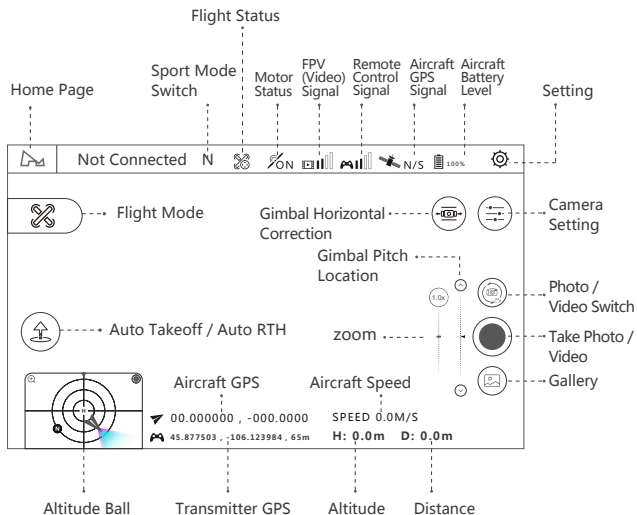

3.3 Pairing The Aircraft

To use the aircraft for the first time, you need to activate the aircraft first :

- ① Press battery switch to power on the aircraft.
- ② Press the remote control switch to connect to the mobile phone, and wait for the remote control to connect the aircraft in success.
- ③ Open the mobile phone X-HUBSAN 2.0 APP, it will automatically jump out of the activation interface.
- ④ The new user can register an account as the activation account, and the old user who has logged in to the APP before can directly enter the password to activate it.

(1) Run X-HUBSAN 2.0 APP, and select the aircraft model.

(2) Short press, the aircraft power button, then press and hold for a few seconds to turn it on.

(3) Short press the transmitter power button, then press and hold for a few seconds to turn it on, connect the transmitter to your mobile device with the RC cable.



(4) Start binding (This step is only required when first binding or replacing the transmitter, you need to do it manually.)

1. Go to APP - Setting - Controller, transmitter connection method: SyncLeas2

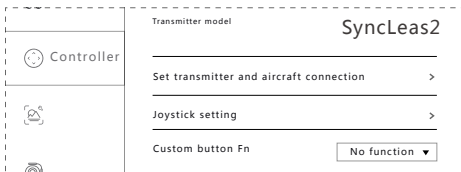

2. Long press the aircraft bind button to enter the binding mode.

3. Select "Set transmitter and aircraft connection" and scan aircraft.

4. Select the aircraft and connect.

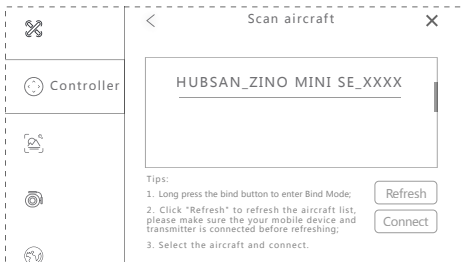

You have to complete the binding process on APP, only when first time using the drone or if replacing the new transmitter.

Tips:

-The binding process has been completed in the factory. Generally, user only need to do the first 3 steps.

-After entering binding mode, the Image Indicator(yellow) flash rapidly and become solid (yellow) after binding is successful.

-Please keep the remote controller at least 1 meter away from drone during binding process.

3.4 Aircraft Calibration

3.4.1 Horizontal Calibration

During the flight, if the drone shows a significant horizontal deviation, please land and disarm the drone. place the drone on a perfectly leveled horizontal ground. Enter the APP setting interface, select horizontal calibration. Drone will automatically perform the calibration, the four heading lights will flash, and it will stay on after the calibration is completed.

Do not move the aircraft during calibration.

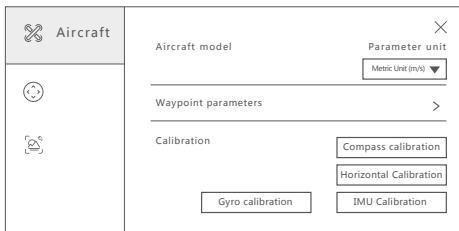

3.4.2 Compass Calibration

When using the drone for the very first time, the compass calibration message will pop up before takeoff. Follow the instructions on your screen, rotate the drone horizontally, then point the drone nose to ground and rotate it clockwise. The compass calibration message will disappear once it is completed. You must complete the compass calibration before flying the aircraft for the first time.

The compass is susceptible to interference from other electronic devices, resulting in abnormal flight data. Regular calibration helps to keep the compass and its readings accurate. select "Compass Calibration" under APP setting interface.

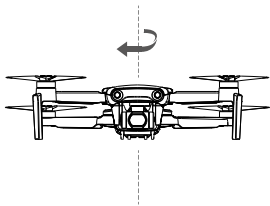

Compass 1

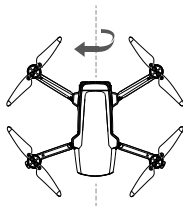

Compass 2

3.5 Starting/Stopping the Motors

Motor starting condition

- (1) The aircraft, remote control, and mobile phone have been connected successfully ;
- (2) The aircraft compass has been calibrated (APP doesn't prompt to calibrate the compass) ;
- (3) The aircraft must be placed on a horizontally leveled ground ;
- (4) Aircraft has not locked sufficient GPS satellites for positioning. please don't force take-off ;
- (5) The power of the drone should be $\geq 15\%$;

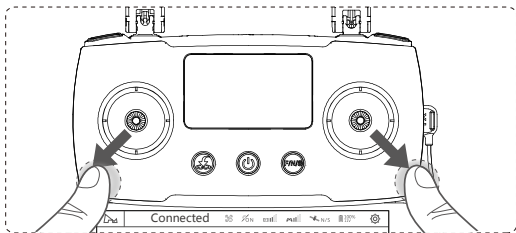

Starting the Motors

Push both sticks down and outwards as shown in picture to start the motors. Once the motors start spinning, Release both sticks.

Stopping the Motors

When the motors are running, Push both stick down and outwards again to stop the motors. Release both sticks once motors stop.

Forced Motor Stop

When flying in the air, the motors can be forced to stop in 2 seconds by push both sticks down and outwards. Use this function with caution, as it can cause the aircraft to fall and may endanger personal safety.

4 Aircraft Functions

4.1 Flight Control Mode

Flight Control Mode	
(The flight controller monitors the GPS signals and switches to the corresponding flight modes)	
GPS Mode	Use GPS and downward vision positioning system to achieve precise hovering, stable flight, intelligent flight mode, etc. The vision system works in a well-lit environment .
Optical flow mode	this mode works indoors only if the altitude is less than 5 meters. more than 5 meters altitude requires the GPS mode or Attitude mode. In optical flow mode, the maximum flying speed of the aircraft is 2m/s.
Attitude mode	The aircraft automatically changes to Attitude (ATTI) mode when the Vision System are unavailable or disabled and when the GPS signal is weak or the compass experiences interference. It only supports manual flight, and prohibits smart flight modes. In Attitude mode ,the aircraft won' t hold position itself, Fly with caution (this mode is only for experienced Drone pilots)

Flight Speed	
Movie Mode	Maximum speed 3m/s
Normal Mode	Maximum speed is 10m/s, adjustable in APP settings from 10% -100%
Sport Mode	The maximum speed is 16m/s, the sport mode is only available in the GPS mode.

4.2 Aircraft Indicator

Video Indicator (Red) 、 Image Indicator (Yellow) Functions Indicator	
Camera Error	Red LED flashes slowly (1 time/second)
Function Error	Red LED 、 Yellow LED off
Booting	Red LED 、 Yellow LED off
Video Indicator Working	Red LED solid
Image Indicator Working	Yellow LED solid
Binding mode	Yellow LED flashes quickly
Disconnected	Yellow LED flash quick and slow
Upgrading	Red&Yellow LED from flashes quick to slow (Flashing quickly when transferring files, and slow flashing when writing flash)

4.3 Return-to-home(Rth)

There are three types of RTH: One-key RTH, Low Battery RTH, and Failsafe RTH. When taking off, and GPS has locked more than 6 satellites, the aircraft will mark take off point as home point. If there is no GPS signal and drone is forced to take-off, Whenever GPS locks more than 6 satellites, it will record that point as home position.

RTH-Process

1. Ensure the "home" point is recorded.
2. Press the return to home icon
3. The aircraft will adjust its direction.
4. The aircraft will climb to the safe altitude as set in the App
 - (1) Regardless of the current height of the aircraft, if the aircraft is within 5 meters of the horizontal distance from home point, it will land;
 - (2) If the horizontal distance from home point is between 5 - 20 meters, aircraft will return at the current altitude;
 - (3) If aircraft is more than 20 meters away, if the altitude of aircraft is more than the set return altitude ,it will return on same altitude, else it will climb to set return altitude ,and then return to home;
5. Search for the Aircraft parking apron during the landing process (This feature must be turned on in app before taking off and or landing)

One-key RTH

APP one-Key RTH / remote control one-Key RTH

Low Battery RTH

1. The aircraft will automatically Return to home according to its own power calculations and the distance from the Home Point.
2. Aircraft will land automatically at the same point upon low battery RTH activation, If there is no GPS signal or weak GPS signals
3. When taking off, if it is forced take off with weak GPS signals or GPS signals are not good, the aircraft will automatically return to the place where it achieved, good GPS signal for the first time.
4. If the power is less than 1% or the battery voltage is less than 5.6V, aircraft will enter in forced landing mode.

Failsafe RTH

When the aircraft loses connection with the remote control for more than 5 seconds, the aircraft automatically returns or land directly. Performance requirements:

- (1) After the aircraft loses control for 5 seconds, it triggers automatic return;
- (2) If the drone reconnects, it will continue to perform the returning procedure when Failsafe RTH mode is activated;
- (3) Landing directly when there is no GPS signal or the signal is not strong.

4.4 Landing Apron Search

When the aircraft is landing or returned to a height of about 10 meters from the ground, it will automatically enter the search for the drone apron function.

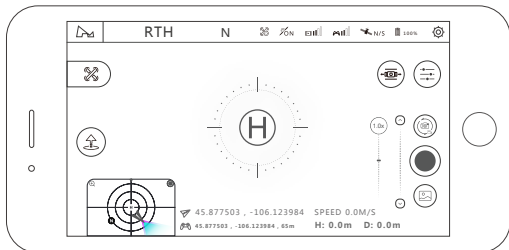

- (1) The gimbal camera points downward to optically search for the Aircraft parking apron[H], Apron requirements: 1 Sharp contrast, 2 white "H" lettering, 3 Apron without obstruction.
- (2) Once drone locks the apron visually it will descend smoothly on apron. When landing to a height of less than 3 meters, the aircraft camera will switch to forward view and no longer adjust the position of the aircraft. From this altitude aircraft will land quick. If an error is identified or other unexpected circumstances occur, press the stop button to exit the function.
- (3) If aircraft can't find the parking apron or battery is critically low, the aircraft will land directly.
- (4) The search for the Aircraft parking apron function cannot be performed if video is being recorded.
- (5) If you do not need to use this feature, please turn it off in app.

4.5 Optical Flow Vision positioning System

The aircraft is equipped with a downward optical flow vision positioning system, which is composed of a downward vision camera and a TOF (time of flight) sensor so that the drone can hover stably at low altitudes without GPS or when weak GPS signals.

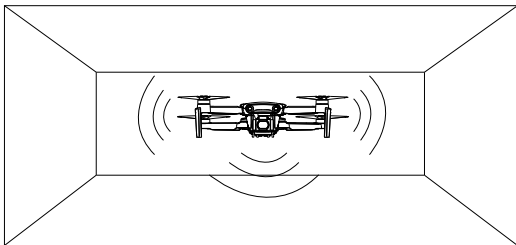

Note (1). The Vision Systems work best with adequate lighting and clearly marked or textured obstacles. It is not designed to completely replace the pilots controls and judgement, please pay attention to the aircraft and HUBSAN APP tips, and do not rely too much on the Visual systems.

(2)The vision system cannot be used normally in scenes where the ambient light is too bright, too dark, specular, water, reflective, sparsely textured, etc.

(3)The best working range of the downward vision system is 0.5-5 meters. When it exceeds this range, the positioning performance may decrease. Please fly with caution.

(4)Keep the Vision sensors clean at all times. Do not obstruct and interfere with the Vision Sensing System.

(5)The optical flow vision system can only be used indoors, and cannot be used outdoors. The drone will switch to GPS hold position mode automatically outdoors.

4.6 Flight Mode

4.6.1 Creative Video

360° Shooting :

- (1) Select the direction of rotation (clockwise / counterclockwise);
- (2) Set the rotation angle, the range of rotation angle (90° - 360° , accuracy 1°);
- (3) Set the rotation speed (1-30 $^{\circ}$ / sec, accuracy 1);
- (4) Click GO, the aircraft rotates in place hovering at its position, shooting a video during the rotation;
- (5) you can click the exit button any time to exit the mode and save the video.

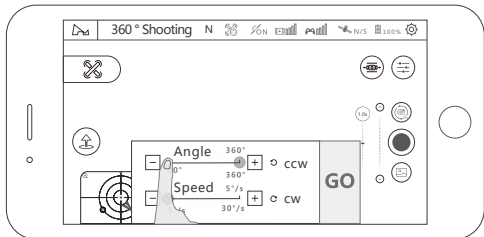

Comet Mode :

After selecting the center point on the APP, the aircraft will automatically fly along the eclipse track and record video. Please only use it in an open area.

APP operation:

- (1) Select the target, the aircraft camera is always aimed at the selected target when shooting
- (2) Select the flying direction (clockwise/counterclockwise)
- (3) Click GO, the aircraft starts recording the video and performs eclipse flight move.

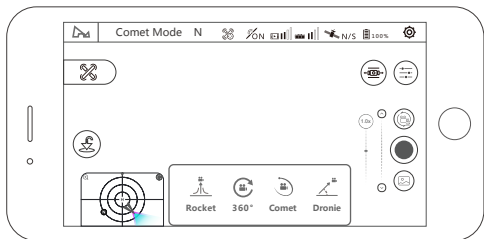

4.6.2 Orbiting

Tap on "Mode Selection" then "Orbit Mode" to set the current location or the position of the mobile device as the center. During Orbit mode, you can adjust the speed and direction by moving the control stick left and right and adjust the orbit radius by moving the control stick forward and backward.

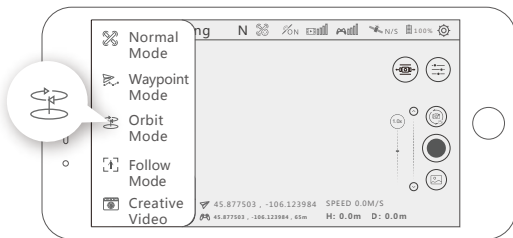

4.6.3 Waypoint

The aircraft will fly along the set flight path drawn on-screen or saved ,you can adjust the speed of the aircraft during flight .

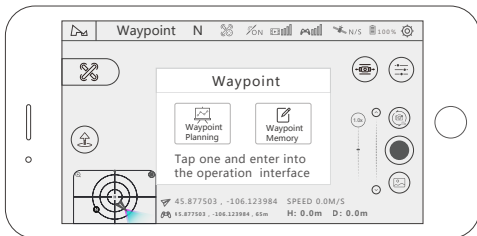

Waypoint Planning: You can preset the waypoint parameters such as the number of waypoints, the altitude of each waypoints and other parameters. The aircraft will follow the preset parameters after you activate waypoint mode. You can control the flying speed during flight or you can pause or resume the Waypoint mode.

Waypoint Memory: After entering the mode, fly the aircraft and tap on "Memorize Waypoints" on the APP and the aircraft will mark the location. After memorizing all the waypoints, upload and execute, aircraft will fly according to recorded waypoints. If the aircraft is not in the starting position, the aircraft will fly to the starting waypoint position before starting this function.

4.6.4 Line Fly Mode

Tap on "Mode Selection" then "Line Fly Mode". Set the angle, distance and speed of the aircraft.

Performance requirements:

1. Set the angle (0 ~ 360 °, accuracy 1 °);
Set the distance (10-6000 meters, accuracy 1 meter);
Set the speed (1-8 m / s, accuracy 0.1);
2. Once setup is complete, the aircraft will execute Line Fly mode.
During the flight, pilots can take photos or videos manually, or pause / resume / stop the flight at any time.
During the flight, you can control the altitude only.
3. You can pause/resume/stop the flight at any time.
4. When the aircraft is low on battery or lost connection from radio, aircraft will always return to home.

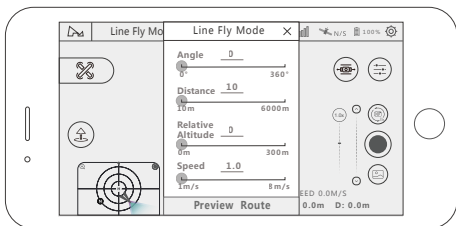

4.6.5 Follow Mode

Enter into follow mode. choose Image tracking and or GPS follow.

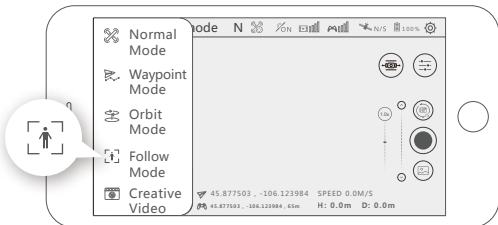
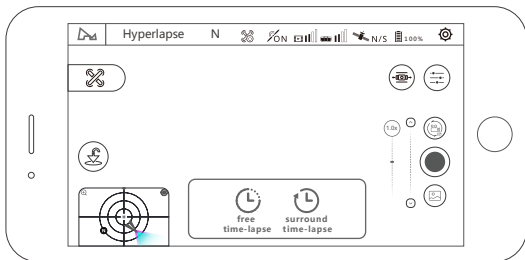

Image Tracking: Select the target on the APP by dragging your finger and drawing a rectangle around the desired target. tap on "Go" and the aircraft will follow the movements of the target. The range of tracking altitude and distance is 5-15 meters. This function cannot be turned on within 5 meters of the distance between the target and the aircraft.

GPS Follow: the aircraft will follow the device when turning on the GPS follow.

4.6.6 Hyperlapse

When you choose Hyperlapse mode , you can choose free and Circle.



Free

The aircraft will take a certain number of photos and compose time-lapse videos automatically according to the parameters set. During the process of shooting, the user can control the flight of the aircraft freely.

- (1) choose free;
- (2) set the shutter interval, the video length, and the maximum flight speed;
- (3) after done, please click ' GO ' and start shooting.

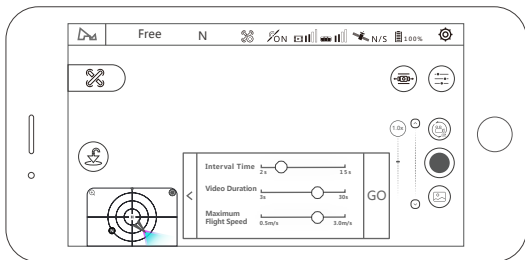

Circle

The aircraft will take a certain number of photos and compose time-lapse video automatically according to the circle point of interest and the parameters set. During shooting, moving any sticks on controller will automatically quit the task.

- (1) select circle.
- (2) set the shutter interval, video length and maximum flight speed.
- (3) set the circle direction, and position the circle center by adjusting the circle radius and the direction of the aircraft nose.
- (4) click 'GO' and start shooting.

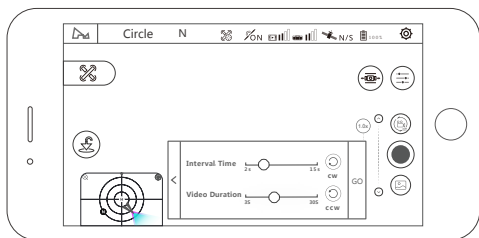

4.6.7 Panorama mode

Set the photo mode in the camera settings to panoramic photo, you can choose spherical, 180°, vertical shooting and wide angle shooting. In this mode, the aircraft will perform the shooting task automatically. After the shooting done, you can view photos and videos from the TF card, also export photos and videos and compose them. You can quit this mode any time during shooting.

Note: Aircraft will not stitch and compose the final panoramas or spheres, you will need to use after market software to perform the stitching.

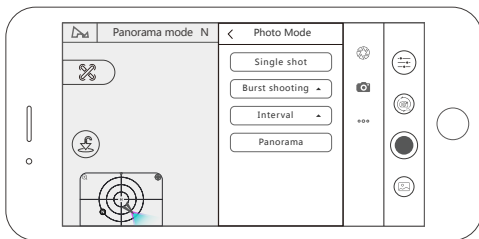

4.7 Gimbal Pitch Adjustment



- Please make sure there are no stickers or impurities on the gimbal before take off, and place the aircraft on flat and open ground. Please do not bump the gimbal after the power is turned on.
- The gimbal contains precision parts. If it is hit or damaged, the precision parts will be damaged, which may cause the performance of the gimbal to decrease. Please take good care of the gimbal and camera from physical damage.
- Please keep the gimbal clean and avoid the gimbal from contacting foreign objects such as sand or stone, otherwise it may block the movement of the gimbal and affect its performance.
- If the aircraft is placed on uneven ground or grass, the ground object touches the gimbal, or the gimbal is subjected to excessive external force (such as being bumped or broken) may cause the gimbal motor to be abnormal.
- Do not add any objects to the camera head, otherwise it will affect the performance of the head and even burn the motor.
- Remove the gimbal protection latch before use and then turn it on. Reinstall the gimbal latch to protect the gimbal during storage or transportation.
- Flying in heavy fog or clouds can cause the gimbal to condense, resulting in temporary failure. If this happens, the gimbal can return to normal after drying.

APP Adjustment

Method 1: long press the blank of the video preview interface and the mobile device will vibrate once. When appears (1) at the position which you press, you can adjust gimbal pitch by sweeping your finger up and down the screen.

Method 2: you can fine tune the angle of gimbal pitch by clicking up-down button(2) on the gimbal pitch axis slider in app

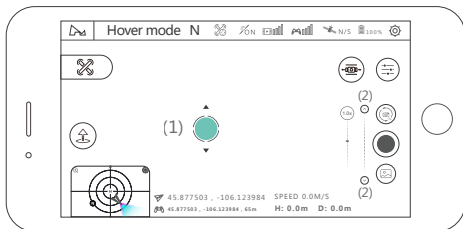

Transmitter Adjustment

You can adjust the angle of gimbal pitch by fiddling with the control thumb-wheel of gimbal pitch.

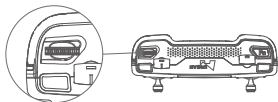

4.7.1 TF Card

- (1) support TF card, U3 above 16G/32G/64G/128G;
- (2) hot plug is supported. You can insert the TF card even if drone is powered on. But it is recommended to plug in the TF card when drone is powered off.

FAQ

1.The mobile device and remote control cannot be connected

- (1) Check whether the status of the APP control signal icon has changed
 - (2) For USB Settings on android phones, check out "Android phone connection tutorial"
2. FPV transmission freezing, gets stuck or easy to disconnect
- (1) Adjust the antenna Angle and point vertical side of the antennas to the aircraft, without anything blocking between antennas
 - (2) Change the flight site, please do not fly near tall buildings, or near signal tower
 - (3) Update the latest firmware

3.Abnormal aircraft hovering

- (1) Change the flight site, please do not fly near tall buildings and signal towers
- (2) Do the compass calibration and horizontal calibration
- (3) Wind is too strong to affect the flight

4. Aircraft GPS accuracy is not precise or cannot pass the GPS accuracy test

- (1) in the open area of the outdoor with GPS over 6 satellite
- (2) Walk around near the aircraft
- (3) Replace the mobile device

5.The battery cannot charge

Re-plug the charger and battery

6. short flight times

Battery overcharge or high temperature environment can easily lead to reduction of battery life, it is recommended to keep the remaining 60% or so, full charge again before use

7. The tilt Angle of the gimbal is too large or the gimbal show abnormal behavior

(1) Restart the aircraft and re-calibrate the gimbal

(2) Check on the APP to see whether the gimbal status is normal

8. Gimbal initialization fails

Before starting the aircraft, take off the protective cover of the gimbal and make sure nothing blocks gimbal movement.

9.The picture is not clear

(1) Check whether the lens protective film is peeled off

(2) Fly in a well-lit environment

(3) Shooting parameters setting in camera Settings of APP

(4) Video source files are saved in TF card files with suffix AA.

10. Lens fogging

(1) humid climate causes lens fogginess, change aircraft storage location

(2)Place some desiccant in the protective cover of the gimbal when storing

11. Picture or video is lost

(1) Perform completing recording operation after recording video, otherwise it may lead to video damage or loss

(2) Check whether the TF card is broken

Limitation of Liability

HUBSAN accepts no liability for damages, injuries or any legal responsibilities directly or indirectly from the use of HUBSAN products under the following conditions:

1. Damages, injuries or any legal responsibilities when users are drunk, under the influence of drugs or anesthesia, dizzy, fatigued, nauseous and / or affected by other conditions both physical and mental that could impair sound judgment and / or personal ability.
2. Subjective misjudgment and / or intentional misoperation of products.
3. Any and all mental damage, trauma, impairment, illness, compensation caused / solicited by accidents involving HUBSAN products.
4. Product operation in no-fly zones (i.e. natural reserves).
5. Malfunctions or problems caused by modification, refit, replacement or use with non-HUBSAN accessories / parts, failure to follow the guidance of the manual in assembly or operation.
6. Damages, injuries or any legal responsibilities caused by mechanical failures due to natural wear and tear (aircraft flight time clocking in 100 hours or above), corrosion, aging hardware, etc.
7. Continued flight after low voltage protection alarms are triggered.
8. Deliberately flying aircraft under abnormal conditions (such as when water, oil, soil, sand or other unknown material are inside the aircraft and / or transmitter are incompletely assembled, the main components have obvious faults, obvious defect or missing accessories, etc).
9. Flying in the following situations and / or environments: areas with magnetic interference (such as high voltage lines, power stations, broadcasting towers and mobile base stations), radio interference, government regulated no-fly zones, if the pilot loses sight of the drone and suffers from poor eyesight or is otherwise unsuited for operating HUBSAN products.
10. Aircraft use in or exposure to bad weather, such as a rain, wind, snow, hail, lightning, tornadoes and hurricanes.
11. Products are involved in / exposed to collisions, fire, explosions, floods, tsunamis, man made and / or natural structure collapses, ice, avalanches, debris, landslides, earthquakes, etc.

12. The acquisition, through use of HUBSAN products (specifically but not limited to aircraft), of any data, audio, video that results in infringement of law and / or rights.

13. Misuse and / or alteration of batteries, product / aircraft circuits, hardware protections (including protection circuits), RC model and battery chargers.

14. Any malfunction of equipment or accessory, including memory cards, that results in the failure of an image or video to be recorded or to be recorded in a way that is machine readable.

15. Users who engage in reckless, unsafe flying (with or without sufficient training).

16. Non compliance with precautions, instructions, information and operation guidelines / methods given through official Hubsan website announcements, product quick start guides, user manuals, etc.

17. Other losses, damages, or injuries that are not within the boundaries of Hubsan responsibility.

RISK OF EXPLOSION IF BATTERY IS REPLACED BY AN INCORRECT TYPE.

DISPOSE OF USED BATTERIES ACCORDING TO THE LOCAL REGULATIONS.

HAZARDOUS MOVING PARTS KEEP FINGERS AND OTHER BODY PARTS AWAY.

Declaration of Conformity

Hereby, SHENZHEN HUBSAN TECHNOLOGY CO., LTD., declares this product is in compliance with the essential requirements and other relevant provisions of Directive 2014 / 53 / EU. A copy of the original Declaration of Conformity can be obtained at the following address: Unit 2801-2802A, Building F, Xinghe WORLD , Yabao Road, Bantian Street, Longgang District, Shenzhen , China

This product bears the selective sorting symbol for waste electrical and electronic equipment (WEEE). This means that this product must be handled pursuant to European Directive 2012 / 19 / EU in order to be recycled or dismantled to minimize its impact on the environment.

For further information, please contact your local or regional authorities. Electronic products not included in the selective sorting process are potentially dangerous for the environment and human health due to the presence of hazardous substances.

FCC INFORMATION

This equipment has been tested and found to comply with the limits for a Class B digital device, pursuant to Part 15 of the FCC Rules. These limits are designed to provide reasonable protection against harmful interference in a residential installation. This equipment generates, uses, and can radiate radio frequency energy and, if not installed and used in accordance with the instructions, may cause harmful interference to radio communications. However, there is no guarantee that interference will not occur in a particular installation. If this equipment does cause harmful interference to radio or television reception, which can be determined by turning the equipment off and on, the user is encouraged to try to correct the interference by one or more of the following measures:

- Reorient or relocate the receiving antenna.
- Increase the separation between the equipment and receiver.
- Connect the equipment into an outlet on a circuit different from that to which the receiver is connected.
- Consult the local dealer or an experienced radio / TV technician for help. Changes or modifications not expressly approved by the party responsible for compliance could void the user's authority to operate the equipment. This device complies with Part 15 of the FCC Rules. Operation is subject to the following two conditions: (1) this device may not cause harmful interference, and (2) this device must accept any interference received, including interference that may cause undesired operation.

This equipment complies with FCC radiation exposure limits set forth for an uncontrolled environment. This equipment should be installed and operated with a minimum distance of 20cm between the radiator & your body. This transmitter must not be co-located or operating in conjunction with any other antenna or transmitter.

Electrical and electronic equipment that are supplied with batteries (including internal batteries)

WEEE Directive & Product Disposal

At the end of its serviceable life, this product should not be treated as household or general waste. It should be handed over to the applicable collection point for the recycling of electrical and electronic equipment, or returned to the supplier for disposal. Internal / Supplied Batteries.

This symbol on the battery indicates that the battery is to be collected separately. This battery is designed for separate collection at an appropriate collection point.



Please read the operating instructions carefully before use!

- Never leave units unattended when charging
- Unplug the charging cable immediately after charging
- Propellers may cause injury
- This product is not a toy
- Not suitable for children under 14 years of age



Flight Academy

Product name: ZINO MINI SE

Product Standard Number: Q / HBS 001-2017

Vendor: Shenzhen Hubsan Technology Co., Ltd

Address: Unit 2801-2802A, Building F, Xinghe WORLD , Yabao Road,
Bantian Street, Longgang District, Shenzhen

Email: service@hubsan.com

WWW.HUBSAN.COM