

Bugs 3 H



Bugs 3 upgraded with Altitude Hold Mode

Instruction Manual



(Camera not included)



Brushless motor
(180° 1800KV)



Independent ESC
(stuck and high-temperature protection)



Two-direction 2.4GHZ
(weak signal and low voltage remote controller alarm)

Important statement and safety guidelines

Thank you for purchasing MJX product. Please read this manual carefully before use and retain it for future reference.

Important statement

- This aircraft is not a toy, but hobby grade model. It should be assembled and operated properly. Pilot must operate this aircraft in safe way. Improper operation may cause injury or property damage.
- This aircraft is applicable for pilots aged 14+ who are with skilled flying experience.
- Users are in full charge of proper operating this aircraft. Manufacturer and dealers disclaim any responsibility for damages caused by misuse.
- Keep the small accessories away from kids to avoid accident.

Flight safety guidelines

Hobby grade radio control aircraft is somewhat considered to be the highest danger potential article. Users should firmly uphold the principle of “safety comes first”. Never fly the aircraft near airports, above crowds or in zones storing dangerous goods and understand the responsibility of the accident may cause by improper operations.

• Stay away from obstacles, crowds, power lines, trees or waters

Always choose a wide open area for every flight, well away from people and property. Never fly directly over people or animals. Please don't fly in such bad weather conditions as high temperature, snow, strong wind (\geq level 5), rain or fog. Maintain a 7ft (2m) distance from the aircraft when taking off and landing.

• Keep the aircraft in dry environment

The aircraft is composed by sophisticated electronic components and mechanical parts. To avoid damages on the mechanical and electronic components, please keep the aircraft in dry environment and use clean cloth to wipe the surface and keep it clean.

• Practice flying together with skillful pilot

Beginners are suggested to practice flying together with skillful pilot's guidance. Do not fly alone.

● Bear proper operation and safe flight guidelines in mind

Please take a careful look at the manuals before flights for important information of product functions and operation tips, and learn how to use the accessory, safe flight always comes first. Stay informed of and abide strictly by relevant local laws and regulations. Keep away from any non-flight zones and respect other people's privacy.

● Safe flying

Please make sure you are in good shape mentally before every flight. Fly the aircraft as per your flying experience. Never fly under influence of alcohol or drugs. Keep the remote controller at least 20 cm away from your body when flying the aircraft.

● Keep distance from a flying aircraft

Never use your hands to touch a flying aircraft under any circumstance. Don't approach and touch a landed aircraft before its propellers are completely locked.

● Keep away from heat source

The aircraft is made of metal, fiber, plastic, electronic component and other material. Please keep it away from the heat source to avoid deformation or even damage caused by sun exposure and high temperature.

● Environmental protection requirements

To protect our blue planet, so please recycle the aircraft as per local laws and regulations.

Product profile

Product configuration

Package includes

Aircraft (camera not included) X1	Camera mount X1	Protection guard X4
Propeller changing tool X1	Screwdriver X1	Balance charger X1
High landing gear X4	Remote controller X1	Battery X1
Extra Propellers A/B X2	USB cable X1	

Technical parameter of the aircraft

Diagonal: 310mm	Overall height: 145mm	Brushless motor: 1806 1800KV
Gross Weight: about 490g (with high landing gear, protection guard and battery)		
Battery: 7.4V 1800mAh	Charging time: about 5 hours	
Maximum flying time: about 17 minutes(without mounting the high landing gear and protection guard)		

Product assemble

Propellers installation/removal

•Installation

Install propeller A and propeller B on the corresponding motor shaft and fix the rotor propellers tightly by rotating them as per the "lock" direction showed on the propellers.

•Removal

Fix the brushless motor by rotor propellers changing tool and then rotate and remove the propellers as per the "unlock" direction showed on the propellers.

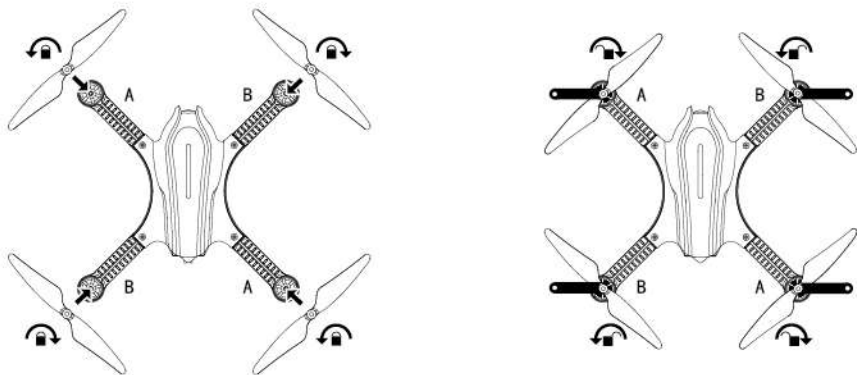

-
- ⚠**
- Please make sure that the clockwise and the counter-clockwise propellers are installed on the correct motors, because the aircraft will not fly normally for wrong propellers installation.
 - Be careful when installing the propellers, as they are a little sharp.
 - Please use MJX propellers for this aircraft.
 - Extra propellers can be ordered additionally.
-

Protection guard installation

First, release the two screws from the bottom of the motors by counter-clockwise. Then, install the protection guard on the corresponding position, and fix the screws by clockwise.



High landing gear installation

Insert the high landing gear plug into the socket locating at the bottom of the aircraft, align the 2 screws positions and fix the high landing gear by screwing clockwise.

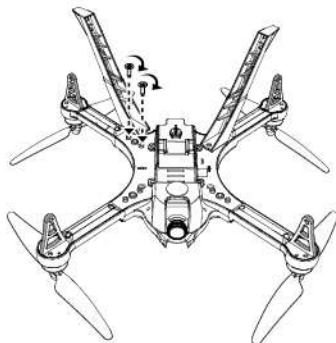

Battery installation

Insert the battery into the battery compartment and make sure the battery is installed in place. Then, insert the power plug of the battery into the power socket locating at the rear of the aircraft.

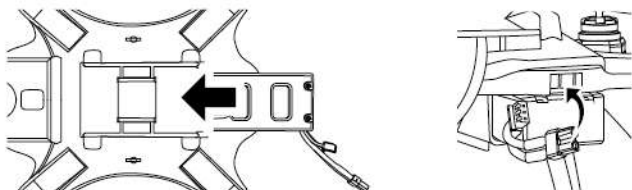

⚠ Note: Please connect the power plug as per the indicated positive and negative polarity.

How to install the battery of remote controller

Open the battery door, install 4*AA batteries into the battery compartment according to the given polarity and then close the battery door.

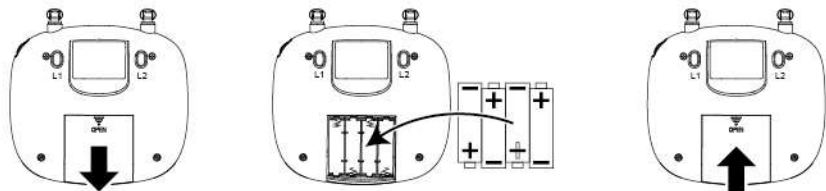

-
- ⚠**
- Insert batteries with correct polarity.
 - Non rechargeable batteries are not to be charged; the transmitter need 4*AA batteries for work.
 - Do not mix old and new batteries.
 - Do not mix alkaline, standard (carbon-zinc), or rechargeable (nickel-cadmium) batteries.
 - Rechargeable batteries are to be removed from the aircraft before being charged;
 - Rechargeable batteries are only to be charged under adult supervision;
 - Exhausted batteries are to be removed from the aircraft;
 - The supply terminals are not to be short-circuited.
-

How to charge the battery of aircraft

Make sure that your power adaptor (5V 1-2A) is connected with the power outlet; connect the balance charger to the power adaptor by plug-in the USB cable accordingly; then, insert the triple-wire plug of the battery into the triple-wire socket of the balance charger and charging is started. Full charging takes about 5 hours.

- When charging is proceeding, the green light keeps flashing slowly and the red light keeps solid on;
- When charging is finished, both of the green light and the red light keep solid on.
- If the battery wire is not connected with the balance charger, but the balance charger is connected with the adaptor, the red light is on and the green light is off.
- Once there is any malfunction, the red light will be solid on and green light will keep flashing rapidly.

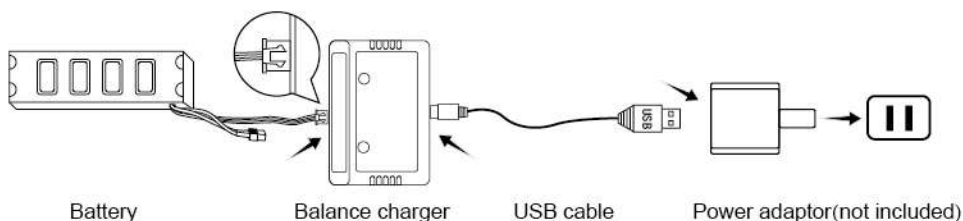

⚠ Warm tips:



- The battery plug should be connected correctly with face up(but not upside down) when plug into the balance charger; Failure to do so will result in battery cannot charge or charger damaged.
- We recommend using 5V adaptor (1-2A) for charging.
- It is not suggested to charge by computer.

- ### ⚠
- Need adult supervision when this aircraft is being played by children.
 - Only batteries of the same or equivalent type as recommended are to be used.
 - Insert batteries with correct polarity.
 - Non rechargeable batteries are not to be charged; the transmitter need 4*AA batteries for work.
 - Do not mix old and new batteries.
 - Do not mix alkaline, standard (carbon-zinc), or rechargeable (nickel-cadmium) batteries.
 - Rechargeable batteries are to be removed from the aircraft before being charged.
 - Rechargeable batteries are only to be charged under adult supervision.
 - Exhausted batteries are to be removed from the aircraft.
 - The supply terminals are not to be short-circuited.
 - The charging line to be used with the product should be regularly examined for potential hazard, such as damage to the cable or cord, plug, enclosure of other parts and that in the event of such damage, the product must not be used until that damage had been properly removed.

Major parts of the aircraft

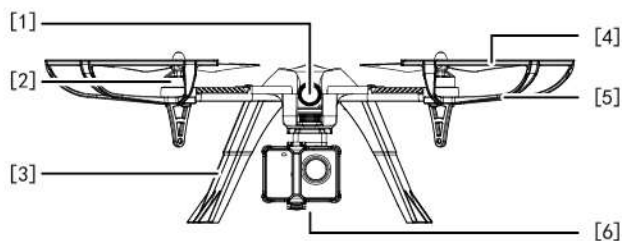

- [1] LED light
- [2] Brushless motor
- [3] High landing gear
- [4] Propeller
- [5] Protection guard
- [6] Camera mount

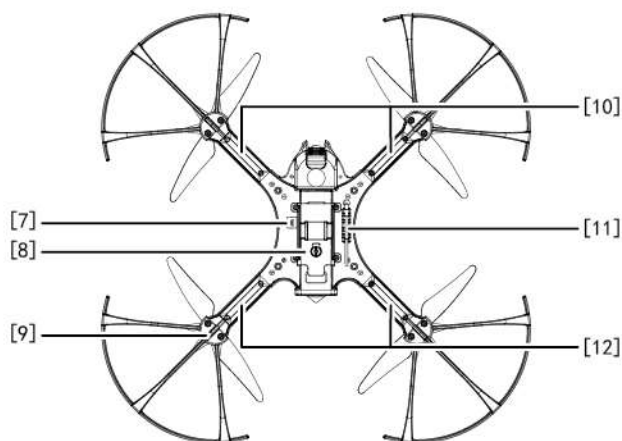

- [7] USB aerial camera port
- [8] Battery compartment
- [9] Bottom landing gear
- [10] Front light
- [11] Antenna
- [12] Rear light

Major parts of the remote controller

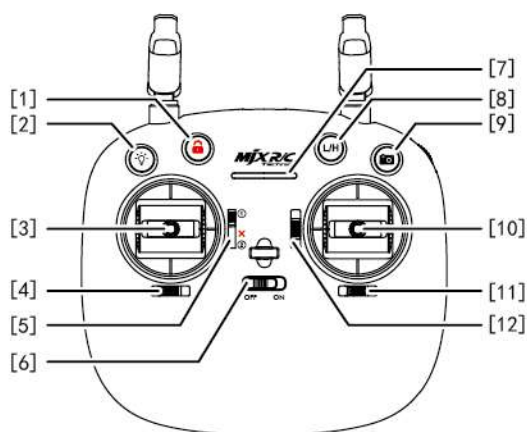

- [1] Unlock (short-press)/
lock (long-press)
- [2] Light switch
- [3] Left stick
- [4] Turn left/right trimmer
- [5] Professional Mode/
Altitude Hold Mode
- [6] Power switch
- [7] Power indicator
- [8] High/Low speed switch
- [9] Photo/shooting
- [10] Right stick
- [11] Leftward/rightward flight trimmer
- [12] Forward/backward trimmer

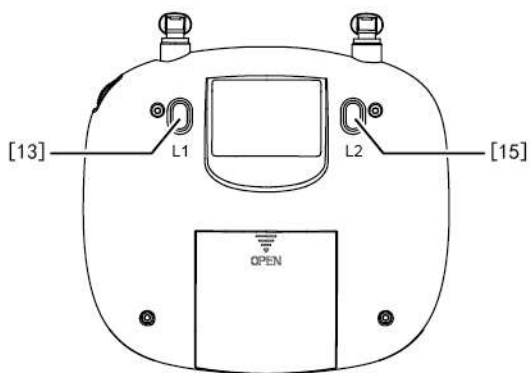

[13] 3D flips & rolls button
 [14] Null button

Camera Mount Installation (Optional Parts)

1. Attach the camera mount to the camera mount fixing connector by aligning the holes and fasten it by screwing clockwise. (Pic. 1)
2. Release the locked buckle of the camera mount; insert the EVA pad into the bottom of camera mount; then install the camera into the camera mount with head up. (Pic. 2-3)
3. Lock the buckle of the camera mount after the camera is installed inside the camera mount completely. (Pic. 4)
4. Fix the camera mount (with camera mount-on) to the bottom of the battery compartment of the aircraft; then lock the buckle at the bottom of the battery compartment. (Pic. 5-6)

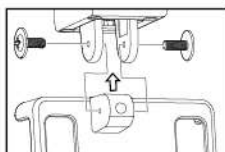

Pic. 1

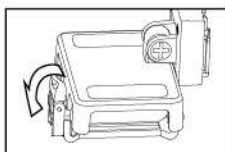

Pic. 2

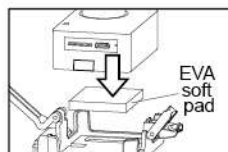

Pic. 3



Pic. 4

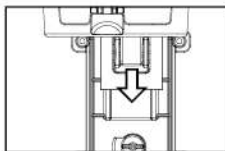

Pic. 5

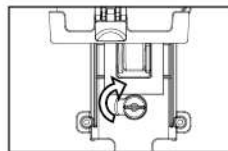

Pic. 6

Remote controller

How to connect the signal of the aircraft with the remote controller

- Keep pressing the red button and turn on the remote controller. The remote controller makes 2 beep sounds, and the indicator light keeps flashing; the remote controller is under signal connection status.
- Turn on the aircraft. The aircraft will make beep sounds with front lights flashing and the aircraft will automatically link to the remote controller. Once the aircraft front lights and the indicator light of the remote controller turn from flashing to solid on, it means that signal connection is succeeded.
(Place the aircraft on the flat ground when proceeding signal connection.)



- Signal connection is done once for all if the remote controller is not linked to other aircraft.
- Set the connection one by one to avoid signal connection error.

Remote controller control stick calibration

1. Keep pressing the red locking button and turn on the remote controller. (shown as pic.1)
2. Push down the calibration button (shown as pic.2) and hold on for 3 seconds, the remote controller will make 3 beep sounds and the indicator light of the remote controller turns from flashing quickly to slowly. Maximum rotate both of the left and right control stick to any direction for 2 circles (shown as pic.3).
3. Then, again, push down the calibration button and hold on for 3 seconds. The remote controller will send out 3 beep sounds and the indicator light of the remote controller turns from flashing slowly to quickly, which means that the control stick calibration is completed.

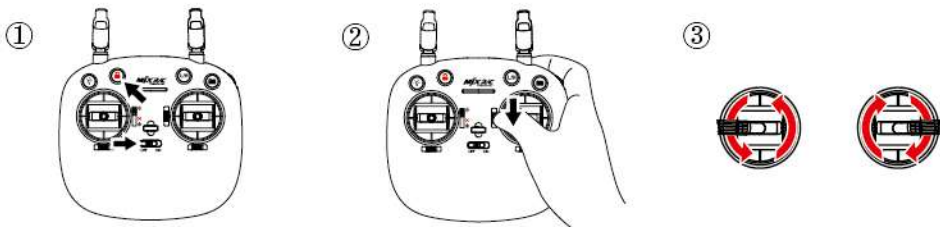

-
- ⚠ Warm tips:** All remote controllers have been calibrated when manufacturing.
Remote controller calibration is requested only if pilots find that the remote controller control sticks are not working normally.
- Attention:** Please do not power on your aircraft when calibrate the control stick for the remote controller.
-

Aircraft gyro calibration

After the aircraft and the remote controller are banded, set the aircraft on flat ground and follow the indication photo as below to calibrate the gyro. Once the aircraft front lights turn from flashing rapidly to solid on, it means that the gyro calibration is succeeded.

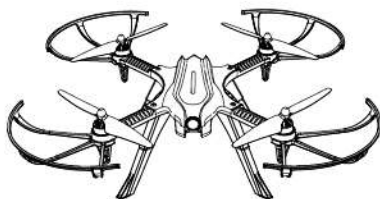

1. Set the aircraft on flat ground.



2. Pull down the control sticks at the same time.

-
- ⚠ Warm tips:** This is not compulsory step. But it is recommended to do gyro calibration for every flight to obtain best flight experience.
-

How to lock and unlock the aircraft

Unlock the aircraft:

Once the aircraft and the remote controller are linked, the front lights of the aircraft keep solid on. Short-press the red button(indicated as below photo), the remote controller makes a long beep sound and the rear lights of the aircraft keep solid on; the motors rotates slowly, the aircraft is unlocked. (Pull down the throttle stick to the bottom position when the aircraft is in Professional Mode.)

Lock the aircraft:

1. When the aircraft in Professional Mode:

Method 1: Long-press the red button, the remote controller sends out “beep ... beep” sound; the motors stop rotating and the rear lights turn off, which means that the aircraft is locked.

Method 2: After the aircraft lands on the ground, pull down the throttle stick to the bottom position for about 15 seconds; the motors stop rotating and the rear lights turn off, which means that the aircraft is locked.

2. When the aircraft in Altitude Hold Mode:

After the aircraft lands on the ground, pull down the throttle stick to the bottom position; the motors stop rotating and the rear lights turn off, which means that the aircraft is locked.



-
- ⚠**
- Signal connection is done once for all if the remote control is not linked to other aircraft.
 - Set the connection one by one to avoid signal connection error.
-

Professional Mode/Altitude Hold Mode

Professional Mode:

When the aircraft in Professional Mode, it doesn't level the aircraft automatically but requires constant manual control to keep the aircraft from losing control and crashing into the ground. It cannot fly with precise positioning and hovering. This is the more difficult mode for flying but also much more responsive. It is great for acrobatics such as flips and rolls by operating the joystick. It requires that pilot should be skillful enough.

Altitude Hold Mode :

The Altitude Hold Mode uses a barometer which measures air pressure as the primary means for determining altitude and if the air pressure is changing in your flight area due to extreme weather, the aircraft will change according to the air pressure change rather than actual altitude. In Altitude Hold Mode, the aircraft maintains a consistent altitude automatically which allows roll, pitch and yaw. This is the best flight mode for aerial photographing.

How to set the flight mode:

Slide the flight mode button to position "①", it is Professional Mode. Slide the flight mode button to position "②", it will change to Altitude Hold Mode accordingly.

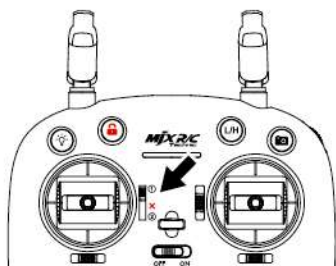

Pic. 1



Pic.2



Warm tips:

1. It is important to slide the button to the exact position when choosing flight mode. It is null at "X" position.
2. Pay attention to your aircraft's flying status and make sure that your drone is under control if you would like to change flight mode when the aircraft is flying.

Operate the aircraft

Remote controller	Aircraft
	<p>Ascent</p> <p>Descent</p>
	<p>Backward</p> <p>Forward</p>

Remote controller	Aircraft
	<p>Turn Right</p> <p>Turn Left</p> <p>Front</p> <p>Rear</p>
	<p>Left Side Flight</p> <p>Front</p> <p>Rear</p> <p>Right Side Flight</p>

Flips & rolls

Flips & rolls operation

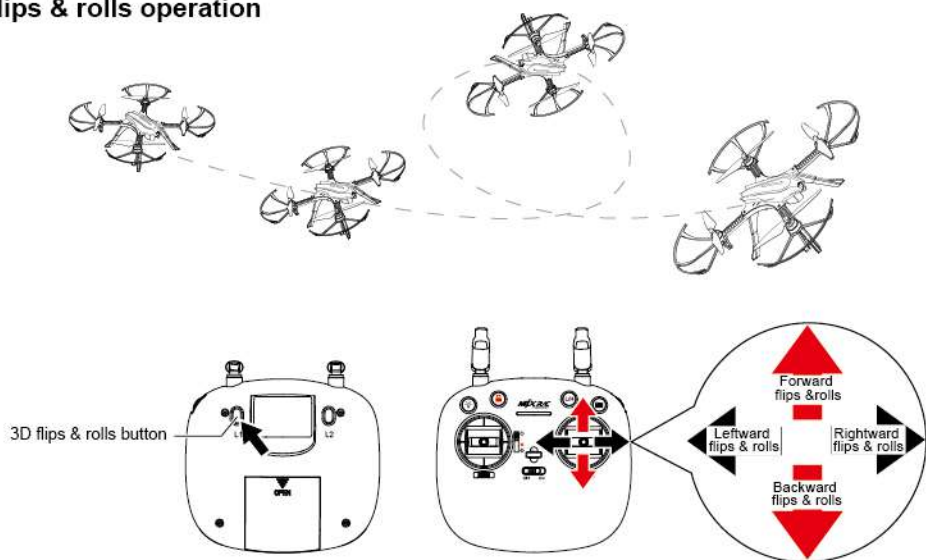

⚠ Warm tips: To flip and roll, please press down the 3D flips & rolls button and push the direction control stick at the same time. If not, the aircraft could not perform flips & rolls action normally.

How to fine-tune the aircraft

If the aircraft keeps moving in any direction even this is no control signal given after flying, users may adjust the remote controller's trimmer button to keep the aircraft balance.

Forward/backward trimmer

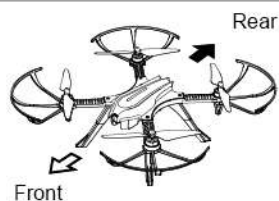

Turn left/ turn right trimmer

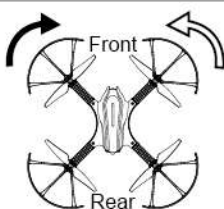

Leftward/rightward trimmer

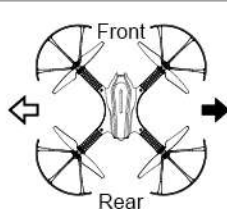

Status indicator

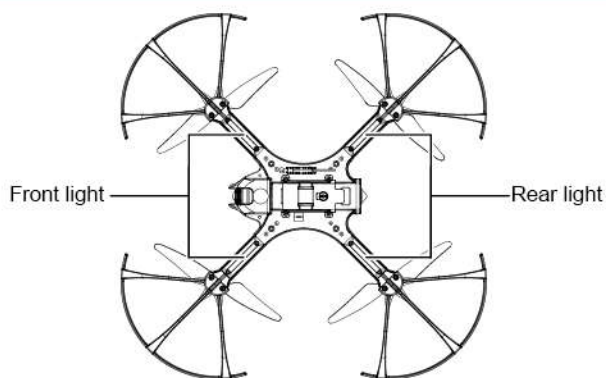

Sound of the aircraft	Status lights of the aircraft	Description
-	The front lights flash rapidly.	The gyro is under calibration status.
-	The front lights flash twice and stop for 2 seconds.	The aircraft is not linked to remote controller or the signal of the remote controller is lost.
-	The front lights flash slowly or the front/rear lights flash at the same time.	The aircraft is underpowered and the remote controller or the aircraft sends out "beep... beep..beep" sound.
-	The front lights keep solid on and the rear lights are off.	The aircraft is under lock status.
-	The front and rear lights keep solid on.	The aircraft is under unlocking or flying status.

Remote controller power indicator light description

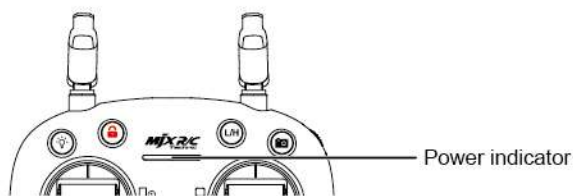

Remote controller sound	Power indicator	Description
Send out continuous beep sound quickly	On	1. The aircraft is too far away from the remote controller that resulted in weak receiving signal. 2. The aircraft is powered off after successful signal connection.
Send out continuous beep sound slowly	On	The aircraft is in low voltage status.
Send out a long beep sound only	On	The remote controller has connected with the aircraft successfully.
Send out "beep beep" sound continuously	Flashing slowly	The remote controller is under power.
Send out "beep" occasionally	On	The aircraft receives very weak signal from the remote controller.

Flight

Before you take off, check and make sure that

- 1.The aircraft and the remote controller are full charged.
- 2.The propellers are installed correctly.
- 3.The motors work normally after unlocking.

Basic flight operations step

- 1.Connect the remote controller with the aircraft.
- 2.Unlock the aircraft after the gyro detection of the aircraft is completed.
- 3.Pull up the throttle stick then the aircraft takes off, and control the aircraft flight by left/right stick.
- 4.Push the throttle stick to the bottom; then, long-press the lock button to lock the aircraft.
- 5.Take out the battery from the aircraft.

Receiver PCB connecting diagram



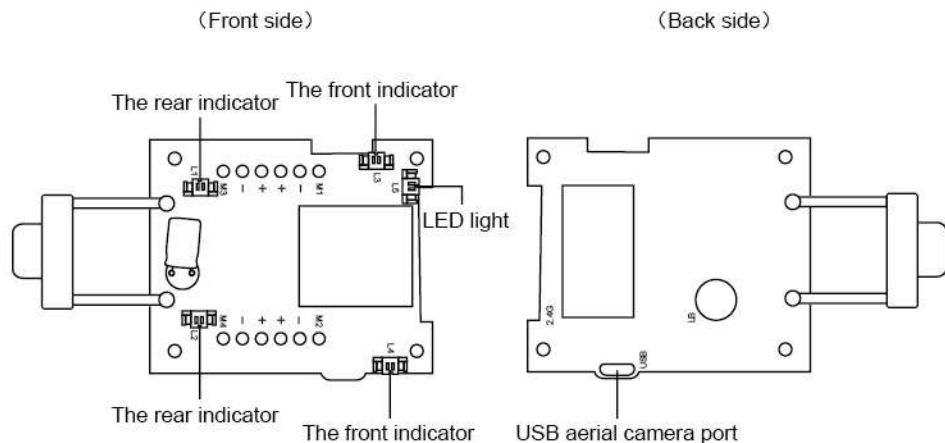



To make sure the aircraft works normally, the installation direction of the flight-control board and the connection location of the insertion wiring must be the same as shown below:







⚠ Warnings: Please purchase MJX camera.

Product components

Basic parts

			
Upper cover B3H001	Main frame B3H002	Flight-control board B3H003	Bottom landing gear B3H004
			
High landing gear B3H005	Battery compartment component B3H006	Screws pack B3H007	Protection guard B30003
			
Propeller A/B B30005	Transparent plastic part B30007	Front light component B30009	ESC B30010
			
Front/back light bar B30011	Clockwise motor B30014	Counter-clockwise motor B30015	Heat sink B30016

			
Propeller changing tool B30017	Battery B30018	Camera mount G5000	Remote controller GR6320D

Optional Accessories

			
FHD Recording Camera C4000	720P HD 5G WIFI Camera C5000	1080P FHD 5G WIFI Camera C6000	

Trouble shooting

No.	Phenomenon	Solution
1	The lights are flashing quickly.	The Gyro of the aircraft is under signal detecting condition, set the aircraft to any flat surface.
2	The aircraft can't be kept balance after taking off and lean one side.	1) Adjust all trimmer buttons to the middle value. 2) Lay the aircraft in the flat surface or flat ground and proofread the gyro of the aircraft again.
3	The aircraft is shaking fiercely.	The rotor propeller is out of shape, change the propellers.
4	The aircraft fails to unlock and the rear lights flash slowly.	The battery is under low power status, please charge the battery to full.

Note:

- a) Changes or modifications not expressly approved by the party responsible for compliance could void the user's authority to operate the equipment.
- b) This equipment has been tested and found to comply with the limits for a Class B digital device, pursuant to part 15 of the FCC Rules. These limits are designed to provide reasonable protection against harmful interference in a residential installation. This equipment generates, uses and can radiate radio frequency energy and, if not installed and used in accordance with the instructions, may cause harmful interference to radio communications. However, there is no guarantee that interference will not occur in a particular installation. If this equipment does cause harmful interference to radio or television reception, which can be determined by turning the equipment off and on, the user is encouraged to try to correct the interference by one or more of the following measures:
- Reorient or relocate the receiving antenna.
 - Increase the separation between the equipment and receiver.
 - Connect the equipment into an outlet on a circuit different from that to which the receiver is connected.
 - Consult the dealer or an experienced radio/TV technician for help.



MADE IN CHINA