

Bugs 6



Bugs Series Racing Drone

Instruction Manual



Brushless motor
(180E 180KV)



4-in-1 ESC
(stick and high-
temperature protection)



Two-direction 2.4GHZ
(weak signal and low voltage
remote controller alarm)

Important statement and safety guidelines

Thank you for purchasing MJX product. Please read this manual carefully before use and retain it for future reference.

Important statement

- This aircraft is not a toy, but hobby grade model. It should be assembled and operated properly. Pilot must operate this hobby model in safe way. Improper operation may cause injury or property damage.
- This aircraft is applicable for pilots aged 14+ who are with skilled flying experience.
- Users are in full charge of proper operating this aircraft. Manufacturer and dealers disclaim any responsibility for damages caused by misuse.
- Keep the small accessories away from kids to avoid accident.

Flight safety guidelines

Hobby grade radio control aircraft is somewhat considered to be the highest danger potential article. Users should firmly uphold the principle of "safety comes first". Never fly the aircraft near airports, above crowds or in zones storing dangerous goods and understand the responsibility of the accident may cause by improper operations.

• Stay away from obstacles, crowds, power lines, trees or waters

Always choose a wide open area for every flight, well away from people and property. Never fly directly over people or animals. Please don't fly in such bad weather conditions as high temperature, snow, strong wind(\geq level 5), rain or fog. Maintain a 7ft (2m) distance from the aircraft when taking off and landing.

• Keep the aircraft in dry environment

The aircraft is composed by sophisticated electronic components and mechanical parts. To avoid damages on the mechanical and electronic components, please keep the aircraft in dry environment and use clean cloth to wipe the surface and keep it clean.

• Practice flying together with skillful pilot

Beginners are suggested to practice flying together with skillful pilot's guidance. Do not fly alone.

● Bear proper operation and safe flight guidelines in mind

Please take a careful look at the manuals before flights for important information of product functions and operation tips, and learn how to use the accessory, safe flight always comes first. Stay informed of and abide strictly by relevant local laws and regulations. Keep away from any non-flight zones and respect other people's privacy.

● Safe flying

Please make sure you are in good shape mentally before every flight. Fly the aircraft as per your flying experience. Never fly under influence of alcohol or drugs. Keep the remote controller at least 20 cm away from your body when flying the aircraft.

● Keep distance from a flying aircraft

Never use your hands to touch a flying aircraft under any circumstance. Don't approach and touch a landed aircraft before its propellers are completely locked.

● Keep away from heat source

The aircraft is made of metal, fiber, plastic, electronic component and other material. Please keep it away from the heat source to avoid deformation or even damage caused by sun exposure and high temperature.

● Environmental protection requirements

To protect our blue planet, so please recycle the aircraft as per local laws and regulations.

Product profile

Product configuration

Package includes:

Aircraft (camera not included) x1 Extra Propellers A/B x2 Propeller changing tool x1
Screw driver x1 USB cable x1 Balance charger x1 Remote controller x1 Battery x1
Silicone rubber ring x4

Technical parameter of the aircraft

Diagonal: 250mm Overall height: 90mm Brushless motor: 1806 1800KV
Gross Weight: about 370g Battery: 7.4V 1300 mAh Charging time: around 4 hours
Maximum flying time: about 12 minutes

Product assemble

Propellers installation/removal

How to install propeller A:

Put the propeller with marking 'A' into the clockwise rotating motor shaft (the side marked A should be upwards.) Then, put the silicone rubber ring into the center bore of the propeller. Last, choose the propeller screw with dot and put it onto the motor shaft; tighten the screws by counter-clockwise.

How to install propeller B:

Put the propeller with marking 'B' into the clockwise rotating motor shaft (the side marked B should be upwards.) Then, put the silicone rubber ring into the center bore of the propeller. Last, choose the propeller screw with dot and put it onto the motor shaft; tighten the screw by clockwise.

How to remove the propeller

Hold the aircraft brushless motor and unscrew the screw without dot by counter-clockwise (screw with dot should be rotated by clockwise) to take apart the propeller.

⚠ Attention: Please install all fittings step by step as below picturers. Keep in mind that the propellers are distinguished by A & B mark and propellers screws are distinguished by dot mark. Please pay attention to your rotation direction.

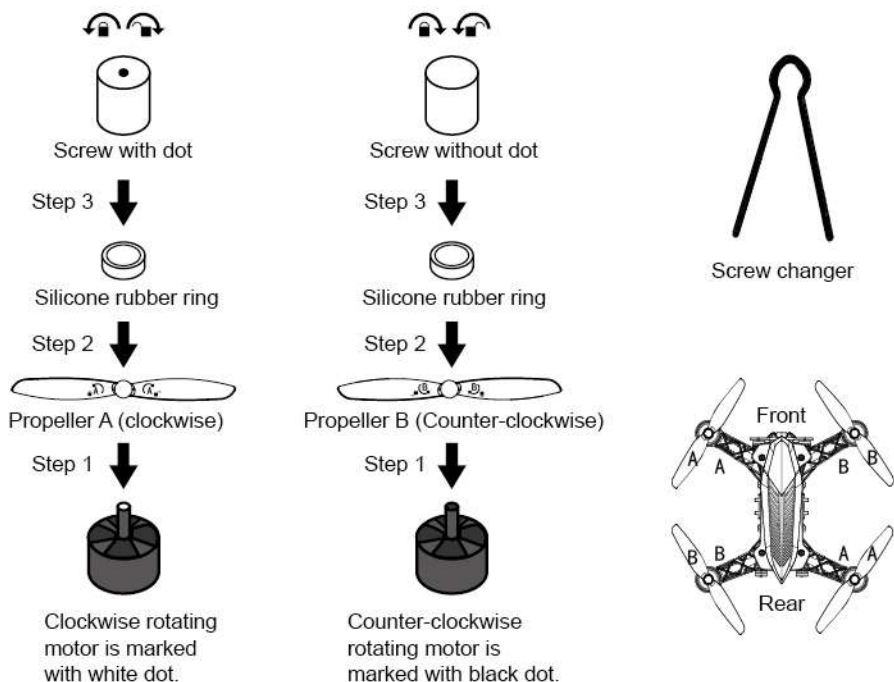

-
- ⚠ Please make sure that the clockwise and the counter clockwise propellers are installed on the correct motors, because the aircraft will not fly normally for wrong propellers installation.
 - Be careful when installing the propellers, as they are a little sharp.
 - Please use MJX propellers for this aircraft.
 - Extra propellers can be ordered additionally.
-

Battery installation

Insert the battery into the battery compartment and make sure the battery is installed in place. Then, insert the power plug of the battery into the power socket locating at the rear of the aircraft.

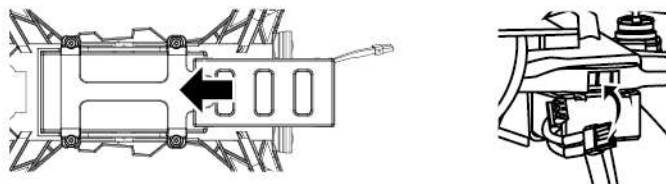

-
- ⚠ Note: Please connect the power plug as per the indicated positive and negative polarity.
-

How to install the battery of remote controller

Unscrew counter clockwise to open the battery compartment cover, install 4x AA batteries into the battery compartment according to the given polarity, screw clockwise to close the battery compartment.

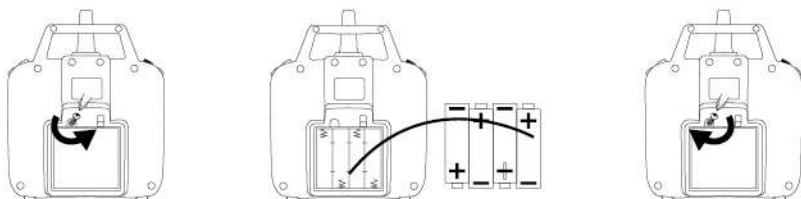

-
- ⚠ • Insert batteries with correct polarity.
 - Non rechargeable batteries are not to be charged; the transmitter need 4 X AA batteries for work.
 - Do not mix old and new batteries.
 - Do not mix alkaline, standard(carbon-zinc), or rechargeable(nickel-cadmium) batteries.
 - Rechargeable batteries are to be removed from the toy before being charged;
 - Rechargeable batteries are only to be charged under adult supervision;
 - Exhausted batteries are to be removed from the toy;
 - The supply terminals are not to be short-circuited.
-

How to charge the battery of model

Connect the balance charger to the 5V adapter by the USB cable and insert the triplex-wire plug into the triplex-wire port of the balance charger .When charging is proceeding, the green light keeps blinking slowly and the red light keeps solid on; when charging is finished, both of the green light and red light keep solid on.If there is no battery being charged, but the balance charger connected to the adpater, the red light is on and the green light is off.Once there is any malfunction, the red light will be solid on and green light will keep flashing rapidly.The charging time is about 4 hours.

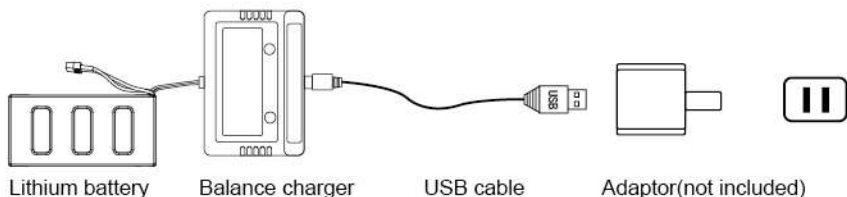

⚠ Warnings: It is recommended to use the 5V 1-2A adaptor for charging.

- ⚠**
- Need adult supervision when this model is being played by children.
 - Only batteries of the same or equivalent type as recommended are to be used.
 - Insert batteries with correct polarity.
 - Non rechargeable batteries are not to be charged; the transmitter need 4 X AA batteries for work.
 - Do not mix old and new batteries.
 - Do not mix alkaline, standard(carbon-zinc), or rechargeable(nickel-cadmium) batteries.
 - Rechargeable batteries are to be removed from the toy before being charged.
 - Rechargeable batteries are only to be charged under adult supervision.
 - Exhausted batteries are to be removed from the toy.
 - The supply terminals are not to be short-circuited.
 - The charging line to be used with the product should be regularly examined for potential hazard, such as damage to the cable or cord, plug, enclosure of other parts and that in the event of such damage, the product must not be used until that damage had been properly removed.

Major parts of the model

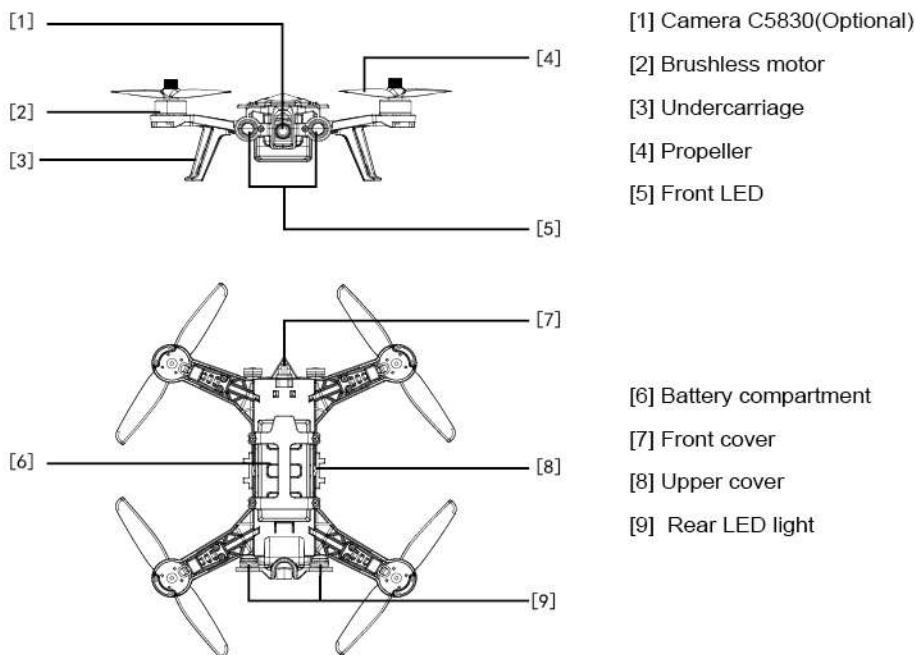

Major parts of the remote controller

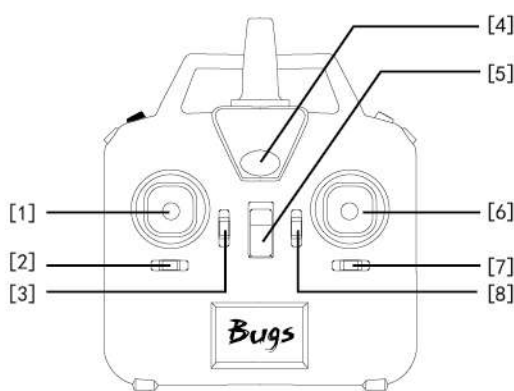

- [1] Left stick
- [2] Turn left/Turn right trimmer
- [3] Reserved for new functions (null)
- [4] Power indicator
- [5] Power switch
- [6] Right stick
- [7] Leftward/rightward trimmer
- [8] Forward/backward trimmer
(Calibration button for remote controller calibration.)

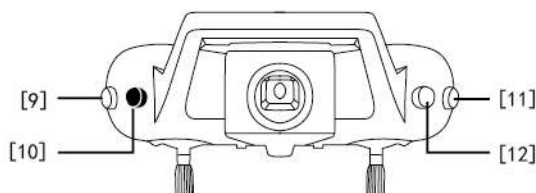



- [9] L/H speed toggle switch(short-press)/ light switch(long -press)
- [10] Unlock(short-press)/ Lock(long-press)
- [11] Photo(short-press)/ shooting switch
(long-press)(applicable when camera is included)
- [12] 3D flip & rolls button

Remote controller

How to connect the signal of the aircraft with the remote controller

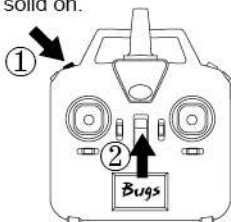
- Press the red button on top of the remote controller and turn on the power of the remote controller. The remote controller will send out 2 beep sounds, and the indicator lights keeps flashing, the remote controller is under signal connection status.
- Turn on the aircraft. Once signal connection is done. The remote controller will send out a long beep sound and the indicator light keeps solid on.



-
-  • Signal connection is done once for all if it is not connected with other aircraft.
- Set the connection one by one to avoid signal connection error.
-

Remote controller calibration

Keep pressing the red button on top of the controller and slide the power switch to the ON position. Push down the calibration button and hold on for 3 seconds. The remote controller will send out 3 beep sounds; the indicator light of the aircraft turns from flashing quickly to slowly. Maximum rotate both of the left and right control stick to any direction for 2 circles. Then, again, push down the calibration button and hold on for 3 seconds. The remote controller will send out 3 beep sounds; the indicator light of the model turns from flashing slowly to quickly, which means that remote controller calibration is completed.

Warm tips:

- All remote controllers have been calibrated when manufacturing.
- Remote controller calibration is requested only if pilots find that the remote controller control sticks are not working normally.

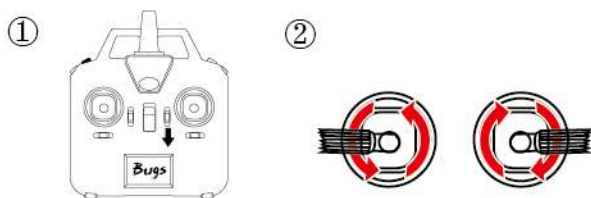

 **Attention:** Please turn off the aircraft while calibrate the remote controller.

Aircraft calibration

Once the gyro detection of the aircraft is finished, push down both of the control sticks to the lower right corner (indicated as below photo). Once the rear light of the aircraft is off, it means that aircraft calibration is succeeded.



How to lock and unlock the aircraft

Unlock the aircraft

Once the gyro detection of the aircraft is finished, the front lights of the aircraft keep solid. Short-press the red button(indicated as below photo).After a long beep sound from the remote controller, the rear lights of the aircraft keep solid, as well. And the motors rotate slowly, the aircraft is unlocked.

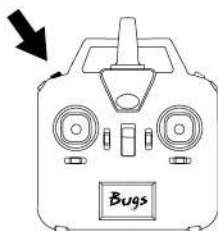

Lock the aircraft

Pull down the throttle stick to the bottom position, long-press the red button (indicated as below photo). The remote controller sends out interrupted beep sound. Then, the motors stop rotating and the rear indicator light is off, which means that the aircraft is locked.

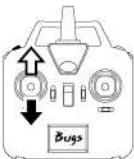

⚠ Warnings: The throttle control stick should be pushed to the bottom position when long-press the red button to lock the aircraft. Otherwise, the aircraft could not be locked.

Operate the aircraft

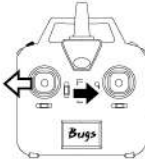
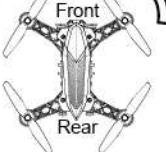
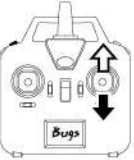
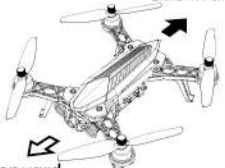
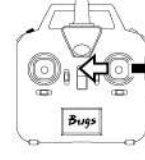
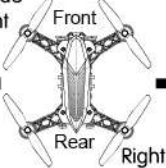
Remote controller	Aircraft	Remote controller	Aircraft
	<p>Ascent</p>  <p>Descent</p>		<p>Turn Right</p>  <p>Turn Left</p>
	<p>Backward</p>  <p>Forward</p>		<p>Left Side Flight</p>  <p>Right Side Flight</p>

Flips & rolls

Flips & rolls operation



⚠ Warm tips:

To flip and roll, please press down the 3D rolling button and push the direction control stick at the same time. If not, the aircraft could not perform flips & rolls action normally.

How to fine-tune the aircraft

If the model keeps moving in any direction even this is no control signal given after flying, users may adjust the remote controller's trimmer button to keep the model balance.

Forward/backward trimmer

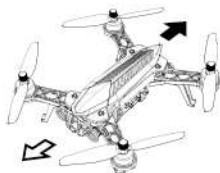

Turn left/ turn right trimmer

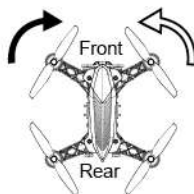
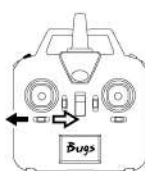

Leftward/rightward trimmer

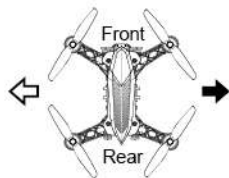

Status indicator

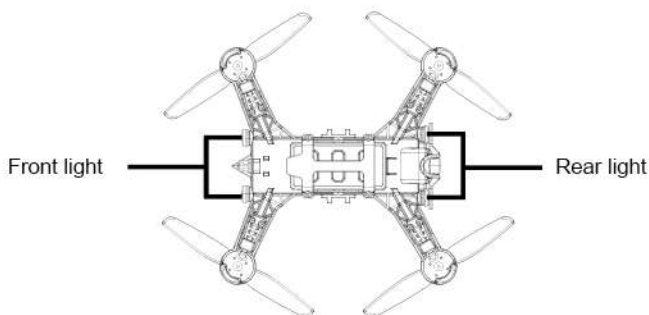

Sound of the drone	Status lights of the drone	Description
-	The rear lights flash quickly	The gyroscope is in the checking state , the drone is fail to connect the signal.
Send out continuous beep sound quickly	The rear lights flash once then turn on for 2 seconds	The signal of remote controller is lost after the aircraft received the signal from the remote controller.
Send out continuous beep sound slowly	The rear lights flash slowly	The aircraft is underpowered and the remote controller send out the sound " beep,.. beep,.. beep,..".
-	The front lights turn on, and the rear lights turn off	The aircraft is under lock status.
-	The front lights power on/off	Turn on or turn off by the remote control.

Remote controller power indicator light description

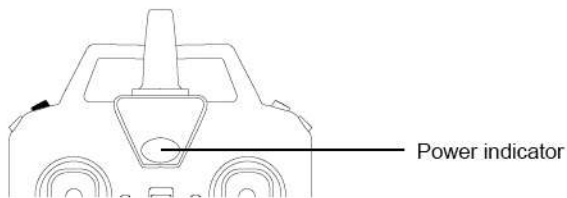

Remote controller sound	Power indicator	Description
Send out continuous beep sound quickly	On	1. The aircraft is too far away from the remote controller that resulted in weak receiving signal. 2. The aircraft is powered off after successful signal connection.
Send out continuous beep sound slowly	On	The aircraft is in low voltage status.
Send out a long beep sound only	On	The remote controller has connected with the aircraft successfully.
Send out "beep beep" sound continuously	Flashing slowly	The remote controller is under power.
Send out "beep" occasionally	On	The aircraft receives very weak signal from the remote controller.

Flight

Before you take off, check and make sure that:

1. The aircraft and the remote controller are full charged.
2. The propellers are installed correctly.
3. The motors work normally after unlocking.

Basic flight operations

Basic flight operations step

1. Connect the remote controller with the aircraft.
2. Unlock the aircraft after the detection of gyro of the aircraft is completed.
3. Pull up the throttle stick then the aircraft takes off, remote control the flight aircraft by left/right stick.
4. Push the throttle stick to the bottom, lock the aircraft by press the lock button for long time.
5. Take out the battery from the aircraft.

Receiver PCB connecting diagram



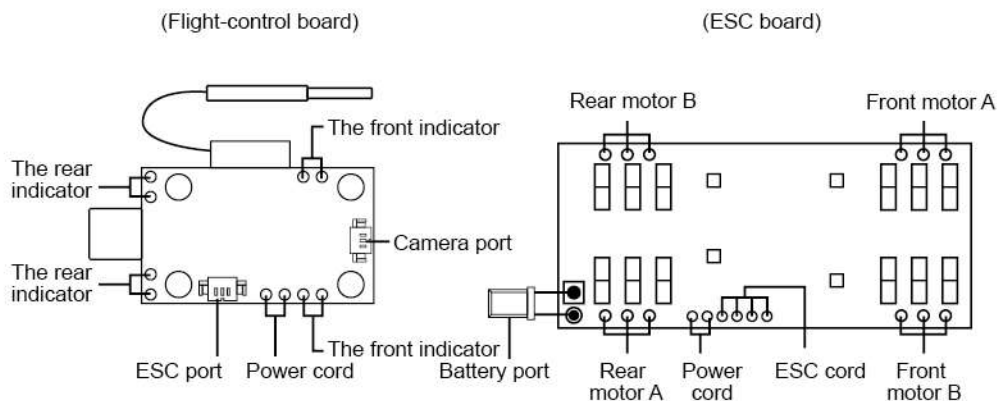













To make sure the drone works normally, the installation direction of the flight-control board and the connection location of the wiring must be the same as shown below:



⚠ Warnings: Please purchase the camera with MJX standard.

Product components

Basic parts

			
Upper cover B60001	Main frame B80003	Propeller A/B B80004	Undercarriage B80005
			
Screw without dot/ Screw with dot B80006	Battery door/ Front cover B80007	Bolt/Antenna buckle/ Lamp cover ring/ Bolt buckle B80008	Lamp cover of the front and rear light B80009
			
Propeller changing tool B80010	Receiver PCB B80011	ESC board B80012	Clockwise motor B80013
			
Counter clockwise motor B80014	Front/Rear light bar B80015	Battery B80016	Silicone rubber ring B80017

			
Heat sink B80018	Remote control GR303B	Balance charger/ USB cable	

Optional parts

			
5.8G Receive screen 4.3-inch LCD Display D43	VR goggles G3	5.8G FPV Camera C5830	

Trouble shooting

No.	Phenomenon	Solution
1	The lights are flashing quickly.	The Gyro of the model is under signal detecting condition, set the model to any flat surface.
2	The model can't be kept balance after taking off and lean one side.	1) Adjust all trimmer buttons to the middle value. 2) Lay the model in the flat surface or flat ground and proofread the gyro of the model again.
3	The model is shaking fiercely.	The rotor blade is out of shape, change the propellers.
4	The drone fail to unlocked, the front indicator flash slowly.	The battery is under low power situation, please charge the battery full.
5	The model can't be locked.	1) Push the throttle stick to the bottom first, then press the lock button for long time. 2) Proofread the stick of the remote control then push the throttle stick to the bottom, later press the lock button for long time.

CE   
MADE IN CHINA