

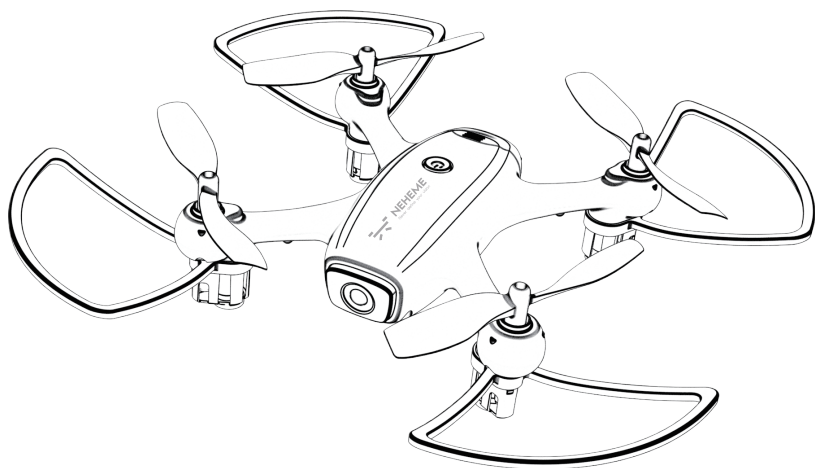

NEHEME
Never define your vision

NH530 Honor Drone



USER MANUAL

» DISCLAIMER AND SAFETY GUIDELINES

1. DO NOT look directly into the drone light.
2. DO NOT treat the product as household waste.
3. DO NOT fly above or near obstacles, crowds, open water, public road, high voltage power lines or trees.
4. DO NOT use the drone in severe weather conditions. These include wind, snow, rain, smog, hail, lightning, tornadoes or hurricanes.
5. Stay away from the rotating propellers and motors to avoid some tiny objects (e.g. hair) to get into them.
6. This drone does not come with GPS module. Please fly the drone within the control range.
7. Be sure to observe all local regulations, obtain appropriate authorizations and understand risks. Please note it is solely your responsibility to comply with all flight regulations.

NEHEME accept no liability for damage, injury or any legal responsibility incurred directly or indirectly from the use of this product. The user shall observe safe and lawful practices including, but not limited to, those set forth in these Safety Guidelines. NEHEME reserves the right to update this user manual.

» MAINTENANCE AND CARE

1. Thoroughly check the drone after crash or violent impact.
2. Do not charge battery before it cools down.
3. Remove the batteries if the product will not be in use for a long time.
4. Do not over charge the battery. Unplug the charger once it's fully charged.
5. Store the drone and remote in a cool, dry place away from direct sunlight.
6. Do not charge the battery next to inflammables, such as carpet, timber floor etc., or on the surface of electro-conductive objects. Please always keep an eye on the battery while charging.
7. Please use the original battery provided. Use an incorrect type of battery may lead to fire hazards.
8. Do not dispose of the battery in fire or a hot oven, cut or mechanically crush the battery, as this may cause explosions.
9. Do not leave the battery in an extremely high-temperature environment that can result in an explosion or the leakage of flammable liquid or gas.
10. Do not expose the battery to the extremely low air pressure, as this may result in an explosion or the leakage of flammable liquid or gas.

» PRODUCT OVERVIEW

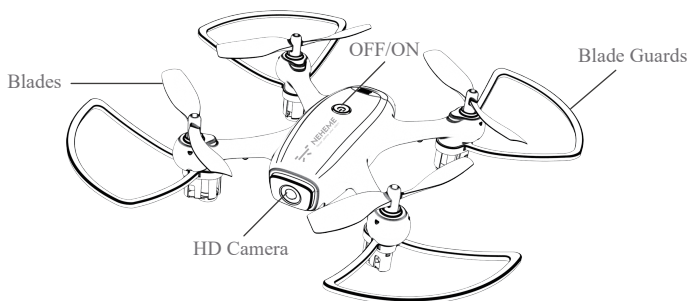
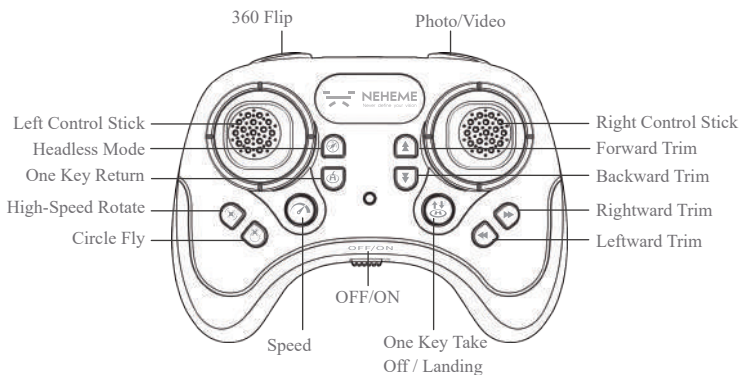

» FLIGHT PREPARATION

1. Install the propeller guards.

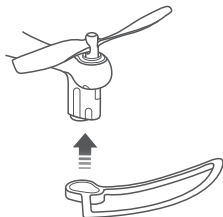

2. Charge the drone battery

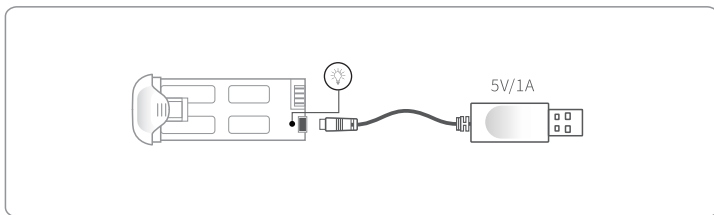

3. Install the battery into the drone after it's fully charged.

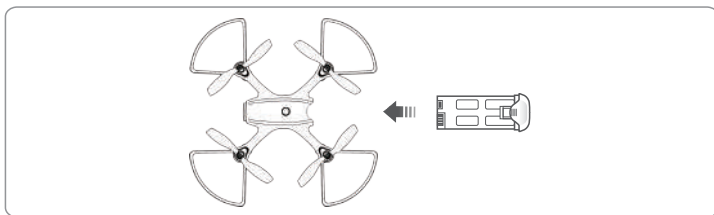

4. Install the remote batteries.

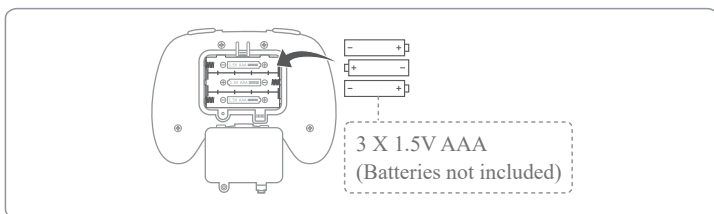

5. Install the Phone Clamp into the remote. (Optional)

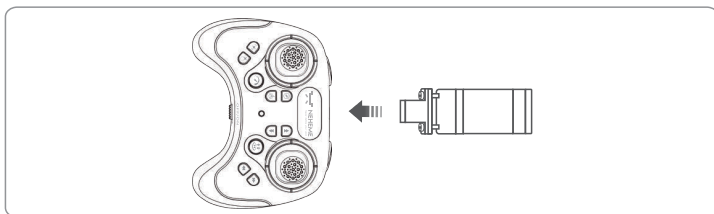

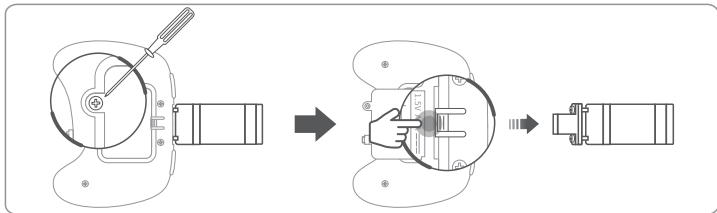

6. Extend the phone clamp to mount your mobile device. (Optional)

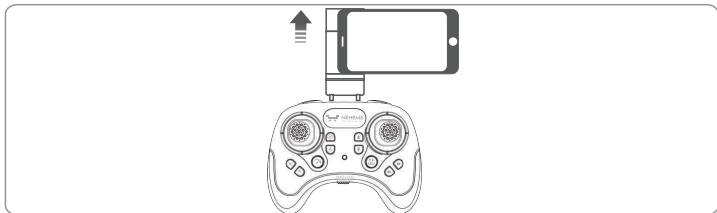

7. Replace the propellers when it's needed. (Optional)

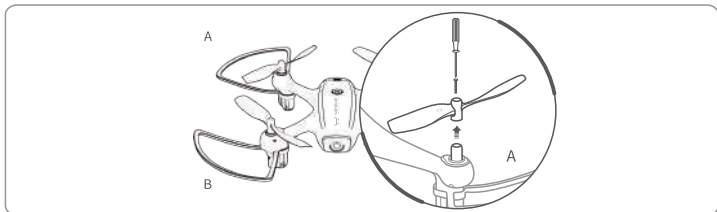

» FLIGHT OPERATION GUIDE

Note:

- * Make sure you power on the drone first, then the remote in each flight.
- * Do repeat the pairing procedure each time when the drone or remote is restarted.
- * For all flight functions and modes, the operator and tail of the drone must be aligned.

Pair the Remote with the Drone

Step 1: Turn on the drone, then the remote. The LED on the drone start to flash, then put the drone on a flat surface with the head forward.

Step 2: Push the **Left Control Stick** forward to the top, then pull it backward till the bottom. Pairing is successful when the LED on the drone is solid on.



Take-off

Option 1:

- Push two levers down to 45° as picture shows, the lights on drone keep flashing, after 2-3s, the lights keep on.
- Press the  button to take off.



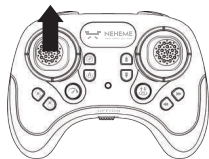

Option 2:

- Push two levers down to 45° as picture shows, the lights on drone keep flashing, after 2-3s, the lights keep on.
- Move the **Left Control Stick** to lower left in 45° and the **Right Control Stick** to lower right in 45° at the same time until four rotor blades start rotating.
- Slowly push the **Left Control Stick** forward to take off.



Landing

- Pull the left control stick down slowly and hold it on the bottom for 2-3s until the blades stop spinning.
- Press the  button to landing.
- Long press  button for Emergency stop, the drone will fall down slowly.





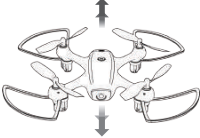
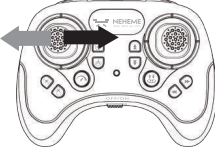
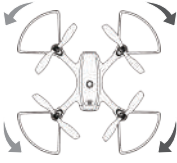

*Long press for emergency stop

Instructions of the Remote



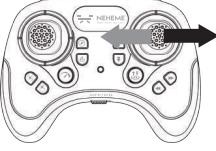

Left Control Stick

<p>Ascend and descend</p> 		<p>Push the Left Control Stick forward and the drone will ascend; pull it backward and the drone will descend.</p>
<p>Rotate Left and Rotate Right</p> 		<p>Push the Left Control Stick leftward and the drone will rotate to the left; pull it rightward and the drone will rotate to the right.</p>

Right Control Stick

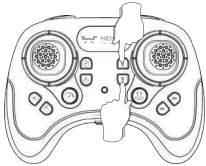
<p>Forward and Backward</p> 		<p>Push the Right Control Stick forward and the drone will fly forward; pull it backward and the drone will fly backward.</p>
<p>Leftward and Rightward</p> 		<p>Push the Right Control Stick leftward and the drone will fly leftward; pull it rightward and the drone will fly rightward.</p>

Flight Trimming

		<p>If the drone drift forward or backward when hovering, press the Backward Trim button or the Forward Trim button to adjust.</p>
		<p>If the drone drift leftward or rightward when hovering, press the Rightward Trim button or the Leftward Trim button to adjust.</p>

Altitude Hold / Hover

This is one of the default settings in the drone. When you release the **Left Control Stick** after the ascending/descending action, the drone will hover at the current flight height. For a stable flight, press the trim buttons to adjust accordingly.

Headless Mode

Press the Headless button to activate the function. In this mode, the drone will fly following the direction of the **Right Control Stick** regardless of the position of your drone's head or the tail. The LED on the drone will flash and there is beeping sound from the remote. Press the same button again to exit this mode.

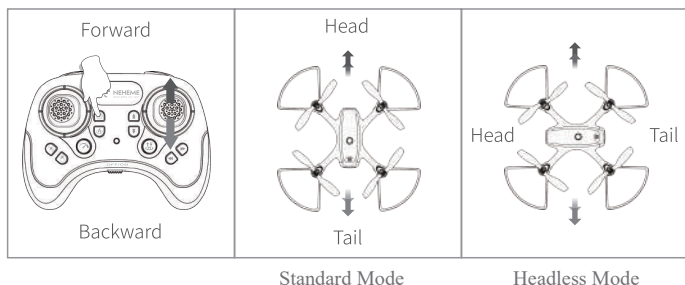

360 °Flip

After flying the drone to a height over 2 meters, press the 360 ° flip button to activate 360 ° flip function. Then move the **Right Control Stick** forward/backward/leftward/rightward to flip the drone accordingly.

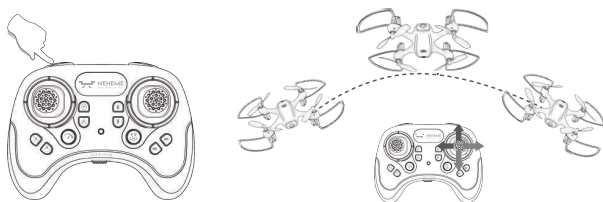

Speed Switch

The drone is set to low speed by default. Press the **Speed button** down once for medium speed and there are two beeps from the remote. Press it down again for high speed and there are three beeps from the remote. A third press will get back to low speed and there is one beep from the remote.

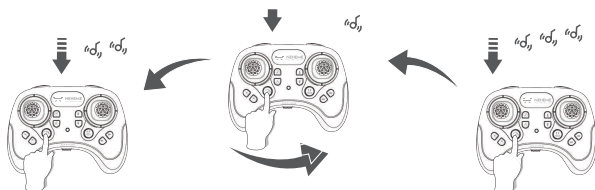

Speed	mph	km/h	m/s
Low	1-3	1-5	0.3-1.5
Mid	4-7	6-11	1.6-3.3
High	8-12	12-19	3.4-5.4

*** Noted:**When you fly in high wind, please use the high speed to control your drone.

One key Return

Press the **(R)** button, and then the drone will fly toward its back following a path parallel to its original take-off path. When the drone is returning, the green rear LEDs on the drone keep flashing.

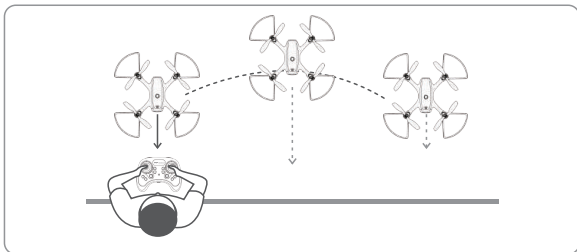

High-Speed Rotation

Press the **(X)** button to make the drone rotate at high speed. Press the button again or move the Right Control Stick forward to exit this mode.

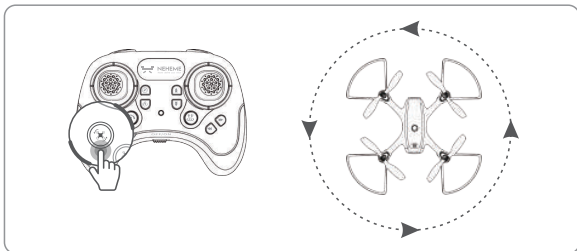

*Note: This function can't be activated when the battery of the drone is low.

Circle Fly

Ensure that there are no obstacles within a radius of 5 meters around the drone. Press the **(X)** button, and the drone will fly in circles. Press the button again or move the Right Control Stick forward to exit this mode.

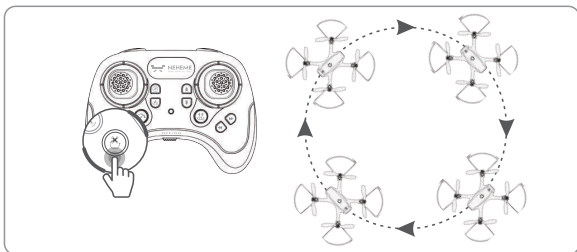

App Operation Guide

1. Download and install **Neheme Honor** into your mobile device from **App Store / Google Play** or scanning the QR code below.



For Android 4.4 or later

For IOS 9.0 or later

2. Turn on the drone first, go to the WIFI settings of your mobile device and connect to the wifi **NEHEME_NH530_*****
3. Open **Neheme Honor** App. Tap **CONNECT** for video viewing surface.



*NOTE:

1. If you want to fly the drone with the controller, then turn on the drone and controller for pairing together first.
2. To fly the drone with App, pair the drone with the app first, then you can use the smart phone to control the drone flying.

► Path Flight:

Tap  to activate this mode. Draw a path in the blank area on the right side of the screen and the drone will fly following the path.



* This function only can be activated in drone controlled by mobile directly.

► Voice Control:

Fly / Land / Forward / Backward / Left / Right.

► VR Mode:

VR device (not included) is required to activate **VR Mode**.

» SPECIFICATIONS

Drone	
Operating Temperature	32°F to 104°F (0°C to 40°C)
Frequency Range	Model NH530: 2.416-2.475 GHz
Remote	
Frequency Range	Model NH530: 2.416-2.475 GHz
Transmit Power (EIRP)	Model NH530: 2.4GHz<18dBm

FCC Caution:

This device complies with Part 15 of FCC Rules. Operation is subject to the following two conditions: (1) this device may not cause harmful interference, and (2) this device must accept any interference received, including interference that may cause undesired operation.

Warning! Any changes or modifications not expressly approved by the party responsible for compliance could void the user's authority to operate the equipment.

NOTE: This equipment has been tested and found to comply with the limits for a Class B digital device, pursuant to part 15 of the FCC Rules. These limits are designed to provide reasonable protection against harmful interference in a residential installation.

This equipment generates, uses and can radiate radio frequency energy and, if not installed and used in accordance with the instructions, may cause harmful interference to radio communications. However, there is no guarantee that interference will not occur in a particular installation. If this equipment does cause harmful interference to radio or television reception, which can be determined by turning the equipment off and on, the user is encouraged to try to correct the interference by one or more of the following measures:

- Reorient or relocate the receiving antenna.
- Increase the separation between the equipment and receiver.
- Connect the equipment into an outlet on a circuit different from that to which the receiver is connected.
- Consult Customer Service or an experienced radio/TV technician for help.

Manufacturer

Guangzhou Huosejie Trading Co., Ltd.

Address: 407-52N, 4th Floor, Building 3, No. 133 Yanling Road, Tianhe District, Guangzhou, China

EC	REP
----	-----

eVatmaster Consulting GmbH
Bettinastr. 30 60325 Frankfurt am Main, Germany
contact@evatmaster.com

UK	REP
----	-----

EVATOST CONSULTING LTD
Suite 11, First Floor, Moy Road Business Centre, Taffs Well,
Cardiff, Wales, CF15 7QR
contact@evatmaster.com

Never define your vision