

# WINGSLAND S6

Quick Start Guide V1.0

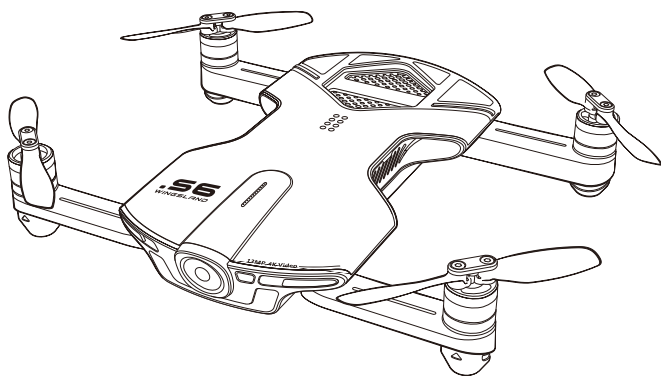

Designed In The Future

## S6 Overview

S6 is a new generation recreational aircraft which is independent developed by WINGSLAND Technology. With folding arms design, 4K electronic image stabilization camera, infrared and optical positioning system, dual-GPS module and extended port, S6 is your super intelligent mini companion to brings you a remarkable flight experience everywhere.

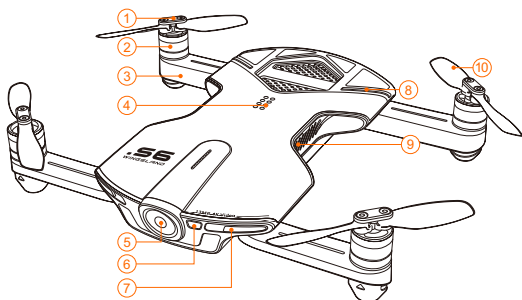

- ① Propeller Lock Screw
- ② Motors
- ③ Arm
- ④ Extended port
- ⑤ Built-in Camera
- ⑥ Flashlight
- ⑦ Front LEDs
- ⑧ GPS state indicator
- ⑨ Ventilation slot
- ⑩ Propellers

- ⑪ Footpads
- ⑫ Optical flow sensor module
- ⑬ Infrared module
- ⑭ Rear LEDs
- ⑮ Battery
- ⑯ Battery lock catch
- ⑰ Power button

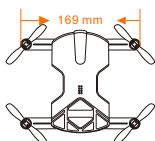
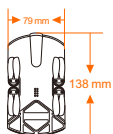
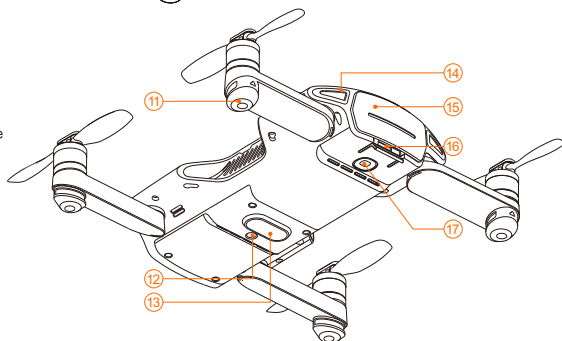



















## WINGSLAND FLY

WINGSLAND FLY is a mobile application designed specifically for the S6. WINGSLAND offers an ideal and powerful mobile device remote solution for configuring the camera, piloting the aircraft through the virtual remote FPV monitor and flight critical information display.

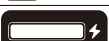

### Introduction of main interface:

	GPS Satellite		Flashlight		General Settings
	Wi-Fi Signal		Timer Photo Settings		Virtual Joystick
	Camera Settings		Photo Mode		Intelligent Orientation Control
	Shutter		Video Settings		Accessories
	Start Video		Auto Take-off		Battery Level
	Stop Video		Auto Landing		
	Timer Photo		Auto Return to Home		

! For more information, please refer to the “S6 User Manual” .

## Flight

### Safety Notice

1. Ensure the flight battery and mobile device are fully charged before flight.
2. Ensure propellers are mounted correctly and firmly.
3. Avoid flying at altitudes above 400 feet (120 meters).
4. Only fly in an open area. Avoid obstacles, crowds, power lines, trees and building, etc.
5. Do not fly the aircraft within areas such as airport, no-fly zone. Observe local laws and regulations.
6. Do not use the aircraft in severe weather conditions: snow, rain, smog, wind speeds exceeding 5m/s, etc.

## Flying Indoor

When flying indoor, the vision positioning system which is assembled at the bottom of the aircraft will help the S6 hovering precisely. The system functions through a monocular camera which obtains location information by real-time image analysis, an Infrared sensor which identify the current height of the aircraft. The system is only valid when the aircraft is between 0.5m and 8m above the surface.

! The performance of the system is affected by the aircraft flying speed, brightness and texture of the surface which the aircraft is flying over. For more information, please refer to the "S6 User Manual" .

## Flying Outdoor

The aircraft will stabilize and hold itself in position and altitude when good GPS reception is available (GPS satellite number  $\geq 7$  ).

When the GPS reception is poor, the Vision Positioning System is not in working situation, the aircraft will use barometer to only maintain its altitude (the aircraft may be drifted by inertia effect). Control the aircraft return to home if a drifting occurs.

## Download App

You can download the WINGSLAND FLY app from App Store, Google Play, WINGSLAND official website or scan the QR code on the S6 package.

! WINGSLAND FLY app supports iOS 8.0 (or later) or Android 4.4 (or later).

## Preparing the Aircraft

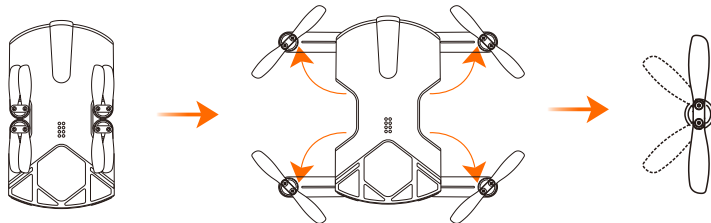

Extend 4 folding arms to the maximum position. Unfold 4 pairs of soft propellers into ready-to-fly form.

## Change the Propellers

Unscrew the covers on the motors, install the new propellers with the same letters/numbers and direction compared with the old ones. Then screw the covers back on the motors firmly.

## Flight Battery

The S6 flight Li-Po battery has a capacity of 1400mAh, a voltage of 7.6v, and with charge/discharge functionality.

Power the battery by using the S6 specialized charging base. A red solid LED indicates the battery is charging, and a green solid LED indicates the battery is fully charged.

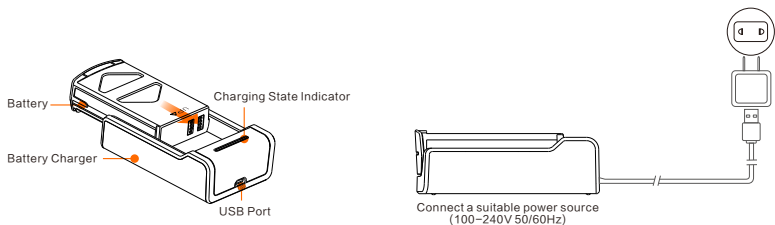

! The data of max flying altitude, max transmission distance and max flight time were tested in a lab environment, vary depending on environmental conditions.

## Install the Battery

Insert the battery into the compartment. The power button is located at the bottom of the aircraft.

Press and hold the power button for 3 seconds to power on /off the aircraft.

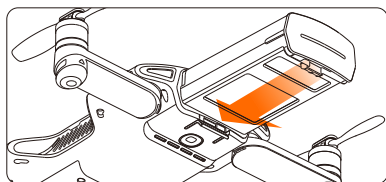

Install the Battery

## Remove the Battery

Filp over the aircraft, use your thumb to lever up the compartment lock and pull out the battery.

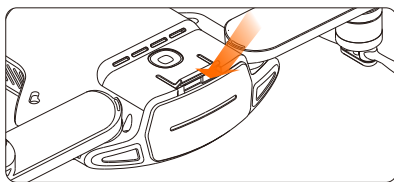

Remove the Battery

## Propeller Guard Installation

Please install the propeller guard before your flight.

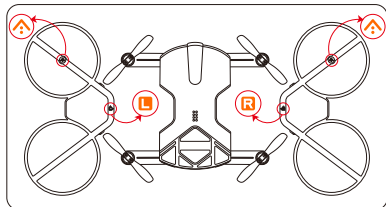

① Place the arrow into the aircraft's nose direction.  
L install on the left side of the aircraft. R install on the right side of the aircraft.

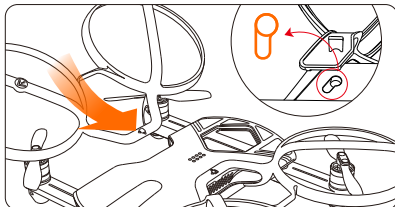

② Put the prop guard into right direction and click on firmly through the 4 grooves  located on the bottom of the aircraft.

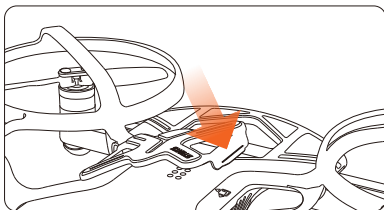

③ Clasp the buckle on one side first, then push the buckle down to lock the prop guard on both side.

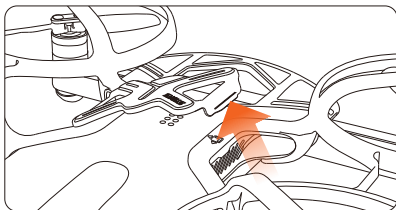

④ To remove the prop guard, gently lever up one side of the buckle first, then take off the buckle and prop guard.

## Connecting the Mobile Device

After powering on the aircraft, turn on the Wi-Fi connection on your mobile device, select WINGSLANDs6\_air\_XXXXXX from the Wi-Fi list, and enter the default password is 12345678. Launch the app when the connection is successful.



## Calibrating the Compass

Make sure to calibrate the compass every time when flying in a new location. The compass is very sensitive to electromagnetic interference that may cause abnormal compass data and lead to flight failure. Regular calibration is required for optimal performance.

When to calibrate:

- Flying in a new location or in a location that is different from the last flight.
- A drift occurs when the aircraft is hovering.

## Calibration Procedures

1. Tap into the compass menu and select the Compass Calibration icon.
2. When the indicators of the aircraft flash slowly, hold and rotate the aircraft 360 degrees clockwise in same altitude for 6 times. Then place it on the ground.
3. The indicators should all be solid and the app displays calibration successful if the compass has been successfully calibrated.



①



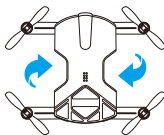

②



③

## Auto Takeoff /Landing

In the flying interface, tap the Auto Takeoff icon , then tap the icon  to activate the feature. The aircraft will automatically hover up and stabilize: 1.5m indoor, 3m outdoor above ground.

After takeoff, the Auto Takeoff icon will change to Auto Landing icon . Check the landing area condition and make sure no obstacle in landing way before the landing.

## Auto Return-to-Home

Press and hold the Auto Return-to-Home icon  in flying interface to command the aircraft return to the last recorded home point. The auto Return-to-Home function can be canceled during a Return-to-Home flight and the altitude of the aircraft can be adjusted during the flight.

**!** The function will be functioning when a sufficient GPS connection is available. For more information, please refer to the "S6 User Manual" .



## Photos/Videos

### Photos

Under single shot mode: Tap shutter  once to take one photo.

Under burst mode: Tap shutter  once to take continuous photos.

### Videos

In flying interface, choose video recording , tap record icon  once to start recording video, then tap again  to stop recording. A recording timer will be displayed during the video shooting.

## Flight Control Modes

### 1. Virtual Joystick Mode

Choosing the Virtual Joystick Mode, two virtual joysticks will be displayed on the app screen to correspond the operation of the remote control sticks. The virtual joysticks are set to Mode 2 by default. The left joystick controls the throttle and rotation of the aircraft, the right joystick controls forward, backward, left, right movement of the aircraft. This control can be changed to Mode 1 through app setting.

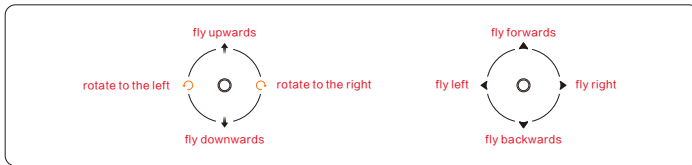

Mode 2

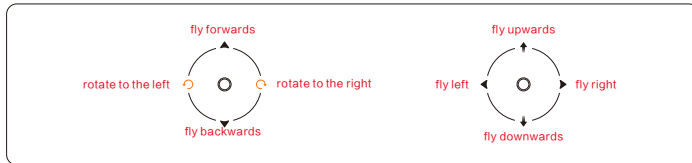

Mode 1

**!** Mode1 - The right joystick serves as the throttle.

Mode2 - The left joystick serves as the throttle.

For more information, please refer to the "S6 User Manual" .

## 2. Motion Sensitive Mode

Motion Sensitive Mode is based on the gravity sensor which built in the mobile device. Choosing the motion-sensitive mode, a joystick will be displayed on left of the app screen, which controls the throttle and rotation of the aircraft. Tap and hold the red round on the right of the app screen. The app will record current inclined position of mobile device as a referenced position. Then tilt the mobile device to control the motion of aircraft when the round turns green: Tilt the mobile device up/down, the aircraft will fly forward/backward. Tilt the mobile device left/right, the aircraft will fly toward left/right.



Motion-sensitive Mode Interface

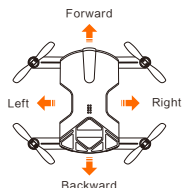

Nose Direction of Aircraft



Aircraft will fly right



Aircraft will fly left



Aircraft will fly forward



Aircraft will fly backward

! Motion Sensitive Mode works only in the operating Mode 2.

## Accessories

The extended port on the upper shell of the aircraft can let you attach compatible functional accessories to expand the possibility of your S6. A 6-ammo 8mm plastic airsoft BB gun for "air battle", a searchlight for "aerial robotic rescue", and a light-up expression screen for "display flying emojis".

Number	Accessories Name	Outline	Function Description
1	Boom Boom		Aim through the crosshair on the app FPV screen, lock the target and fire.
2	Searchlight		Change Brightness level and flash modes of the searchlight in the app.
3	Emoji Display		The display will show the numbers, letters or emoji which are typed in the app.

! For more information, please refer to the "S6 User Manual".



## S6 Specs

Aircraft	
Weight	230g (include battery)
Dimensions	Ready to Fly Form: 138mm*169mm*26.8mm
	Compact Form: 138mm*79mm*26.8mm
Max Flying Altitude	100m
Max Transmission Distance	100m
Max Flight Time	Approx. 10 Minutes
Operating Temperature	0~40°C
Max Wind Capability	Winds Speeds Exceeding 5 m/s
Positioning System	Outdoor: GPS & Infrared and Optical Flow Sensor
	Indoor: Infrared and Optical Flow Sensor
Hover Accuracy	Vertical:
	Horizontal:
APP	
Name	WINGSLAND FLY
Live View Quality	480p, 720p
Latency	200ms (depends on environments and mobile devices)
OS Requirement	iOS 8.0 (or later), Android 4.4 (or later)
Battery	
Capacity	1400mAh
Voltage	7.6v
Energy	10.64Wh
Type	Lithium-ion Polymer Battery
Battery Weight	74g
Charging Environment Range	0~40°C
Discharging Environment Range	0~40°C

Camera	
Sensor	
Lens	
Exposure Compensation	+4,+3,+2,+1,0,-1,-2,-3,-4
Photo Resolution	12M 4032x3024 4:3
	10M 3648x2736 4:3
	8M 3264x2448 4:3
Video Resolution	3840x2160 30P 16:9
	2560x1440 30P 16:9
	1920x1080 60P 16:9
	1920x1080 30P 16:9
Anti-Flicker	Auto, 50Hz, 60Hz
Still Photography Modes	Single Shot Mode, Burst Mode, Timer Photo Mode
Slow Motion Video	Normal, 1x, 2x, 2x
Timer Photo Mode	Turnoff, 5s Delay, 10s Delay
Photo File Formats	JPEG
Video File Formats	Mp4
USB Type	Micro-USB
Wi-Fi	
Name	WINGSLANDs6_xxxxxx,
Frequency	2.4G
Transmitter Power	FCC:23dBm CE:19dBm
Charger	
Charging Port	Micro USB (supports portable power bank)
Input	5V/1A~2A (self-adapted)
Output	8.7V/0.5A~1A (self-adapted)

**FCC Warning:**

This equipment has been tested and found to comply with the limits for a Class B digital device, pursuant to part 15 of the FCC Rules. These limits are designed to provide reasonable protection against harmful interference in a residential installation. This equipment generates, uses and can radiate radio frequency energy and, if not installed and used in accordance with the instructions, may cause harmful interference to radio communications. However, there is no guarantee that interference will not occur in a particular installation. If this equipment does cause harmful interference to radio or television reception, which can be determined by turning the equipment off and on, the user is encouraged to try to correct the interference by one or more of the following measures:

- Reorient or relocate the receiving antenna.
- Increase the separation between the equipment and receiver.
- Connect the equipment into an outlet on a circuit different from that to which the receiver is connected.
- Consult the dealer or an experienced radio/TV technician for help.

Caution: Any changes or modifications to this device not explicitly approved by manufacturer could void your authority to operate this equipment.

This device complies with part 15 of the FCC Rules. Operation is subject to the following two conditions: (1) This device may not cause harmful interference, and (2) this device must accept any interference received, including interference that may cause undesired operation.

This equipment complies with FCC RF radiation exposure limits set forth for an uncontrolled environment. This equipment should be installed and operated with a minimum distance of 20 centimeters between the radiator and your body.



For more information, please refer to the "S6 User Manual".

<http://www.szsungreen.com/support.php>

★This content is subject to change without prior notice.