

# MANTIS Q

Quick Start Guide V1.0

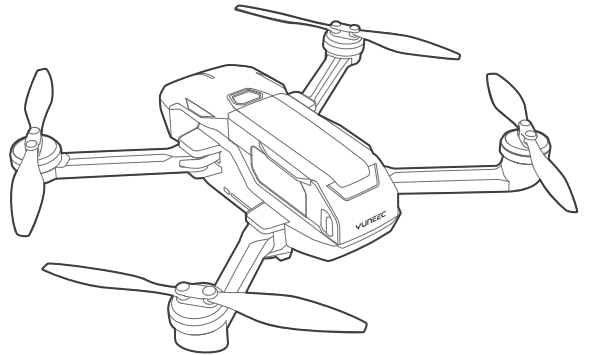

## Product Overview

### Aircraft

Product Name: Mantis Q

Model: YUNMQA

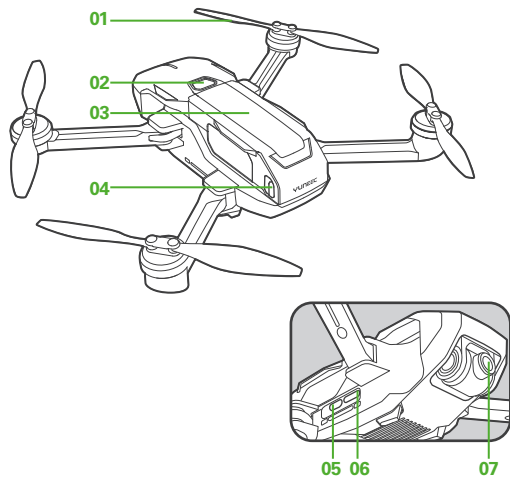

- 01 Propellers
- 02 Power Button
- 03 Battery
- 04 Battery Lock

- 05 USBType-C
- 06 Micro SD Card Slot
- 07 Camera

### Controller

Product Name: Mantis Q Remote Controller

Model: YUNMQRC

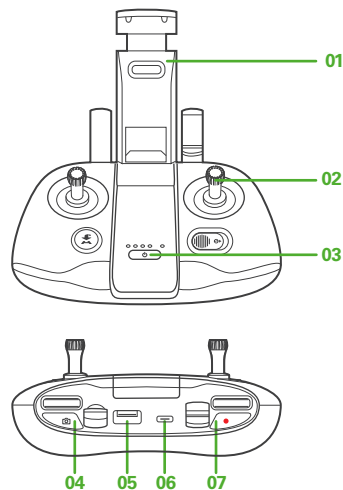

- 01 Phone Holder
- 02 Control Sticks
- 03 Power Button

- 04 Photo Button
- 05 Standard USB Port
- 06 USBType-C
- 07 Video Recording Button

## Before Flight

### 1. Charging the Remote Controller

- Use USB Type-C (only for charging) to charge, approx. 1 hour.

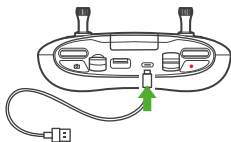

### 2. Preparing the Aircraft

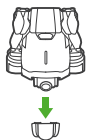

- ▶ Remove the camera protector

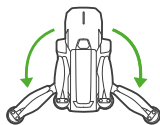

- ▶ Unfold the rear arms

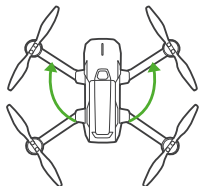

- ▶ Unfold the front arms

- All arms and propellers must be unfolded before powering on.
- To fold the Mantis Q, reverse the unfolding instructions.

### 3. Charging the Flight Battery

- Press the lock button and remove the flight battery.

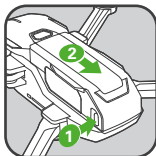

- Charge the flight battery to “Solid Green”, approx. 1.5 hours.

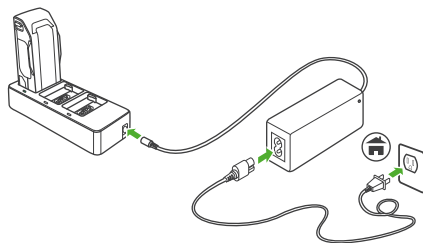

- Push the flight battery into the aircraft until hearing a ‘click’.

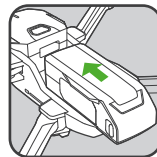

### 4. App Download

- Download Yuneec Pilot App. Mantis Q supports iOS 9.0 (or later) or Android 5.0 (or later).



# First Flight Part 1

## 1. Installing the Smart Device

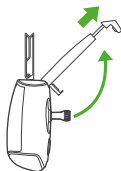

▶ Pull out the phone holder

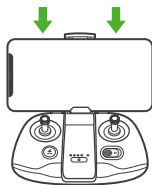

▶ Install the smart phone

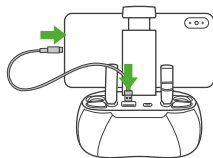

▶ Connect the smart phone with the remote controller (Iphone and Android cable not included)

## 2. Power On

To power on the Mantis Q and the remote controller, press and hold the power button for two seconds until you hear two rising tones.

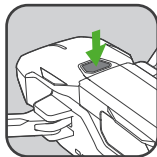

▶ Power on the Mantis Q

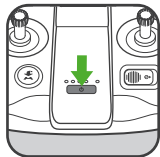

▶ Power on the controller

## 3. Connecting to Mantis Q

- Launch Yuneec Pilot App.
- Follow on screen directions to connect phone or controller to the aircraft.
- For manual connection through WiFi, the password is:1234567890.

## 4. Take Off

- To ensure safe flight, step back approximately 9ft (3m) behind the Mantis Q.

### Option 1

Tap the icon [  ] on the app and then slide to take off.

### Option 2

- Move the sticks for 1.5 seconds as shown below to start the motors.
- Slowly raise Left Stick to take off.

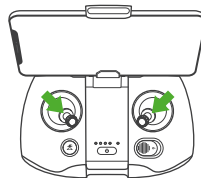

▶ Start the motors.

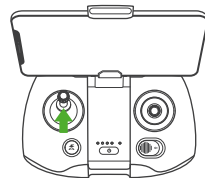

▶ Take off

## First Flight Part 2

### 1.Direction Control

Move the control sticks as below to control the direction of the Mantis Q.

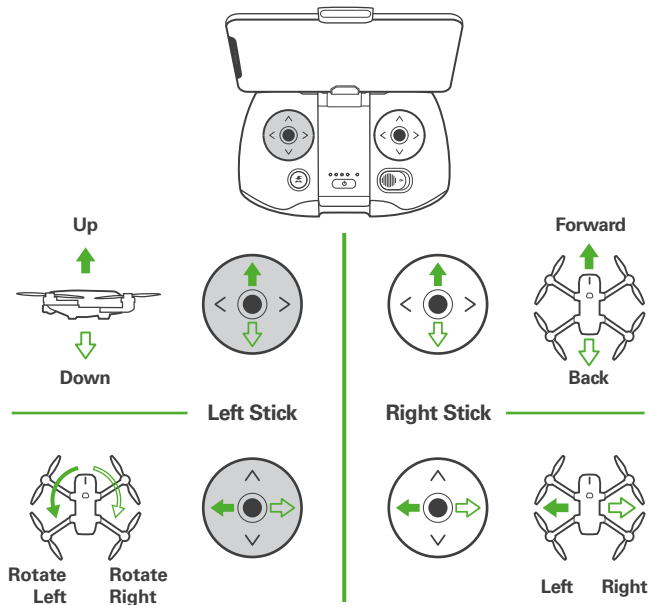

### 2.Landing

#### Option 1

Tap the icon [  ] on the app and then slide to land.

#### Option 2

Slowly lower Left Stick to land. To land properly, ensure that the aircraft is away from any obstacles or obstructions as it will land directly below where it is hovering.

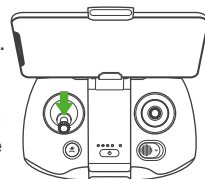

### 3.Power Off

- To power off the Mantis, press and hold the power button for two seconds.
- To power off the controller, press and hold the power button at the center of the controller for two seconds.

\* If you experienced a slight drift during your first flight, it may be best to calibrate your compass. Please go to the Settings section within your app and follow the on-screen instructions to calibrate the compass.

**YUNEEC**

Any information might be changed due to the software update. For the latest documents, please check the official website: [www.yuneeec.com](http://www.yuneeec.com)