



KUN

T R A V E L T H R O U G H

SG908 • HD

Give you extraordinary visual enjoyment

HD video, glasses, monitors



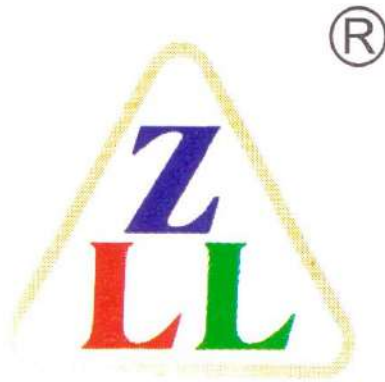

Zhongli Technology

Shantou Zhongli Intelligent Technology Co., Ltd. has been focusing on the development and production of drones, adhering to the brand design concept of "exploration and discovery, enjoying extraordinary wisdom", exploring the beauty of intelligent technology, let us experience the fun brought by intelligent technology together. Let smart technology come into your life, Zhongli UAV, unhindered and free flight.

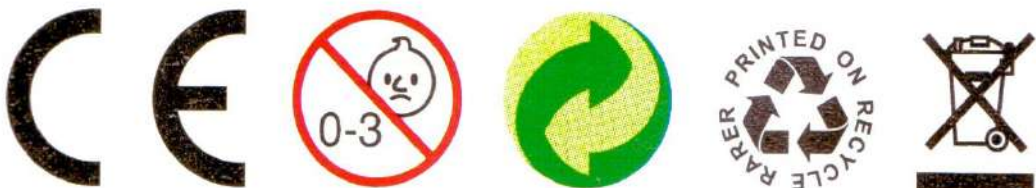

MADE IN CHINA



14+ AGES

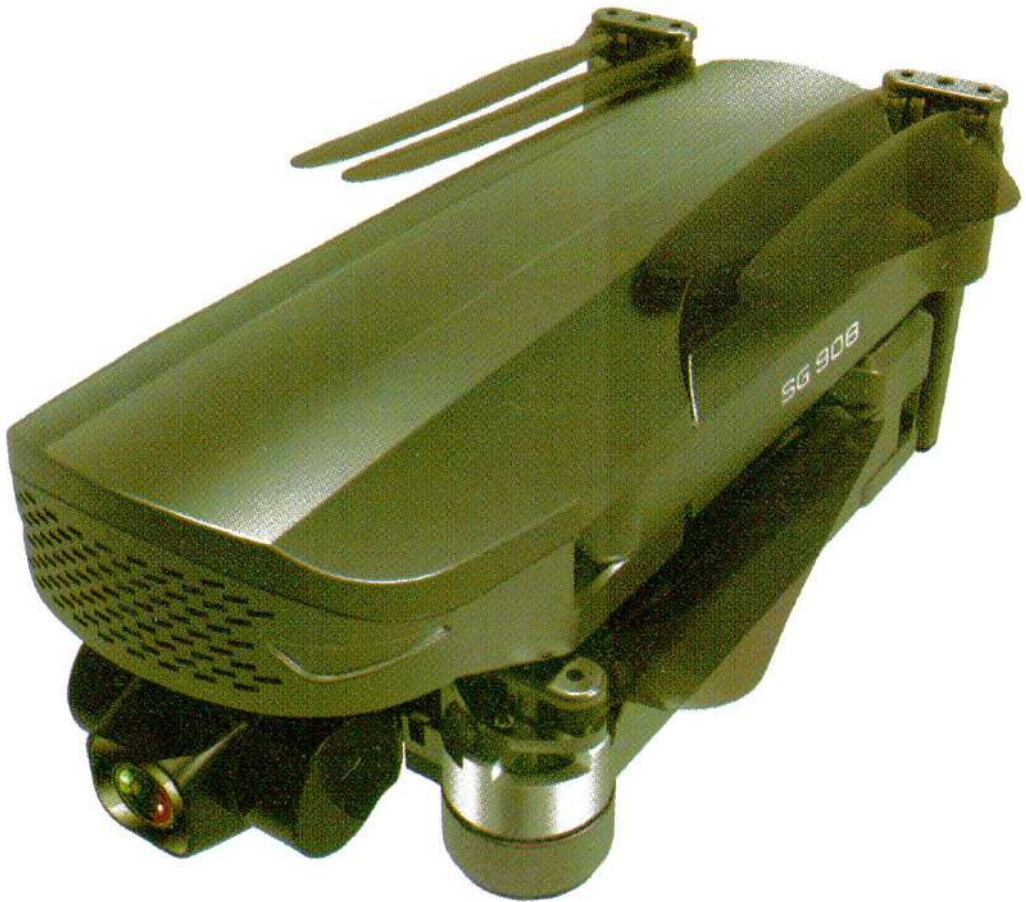

SG908

GPS Smart Drone

* Please read the manual carefully before flight and keep it for future reference.

table of Contents

Quick Start Guide	1
1.Precautions for using PTZ camera.....	1
2.Frequency control between remote control and drone.....	1
3.Geomagnetic correction.....	1
4.Drone gyroscope and gimbal level calibration.....	1
5.Flight mode switch.....	2
6.Drone unlocking.....	2
7.Drone and remote control battery replacement and charging.....	2
8. Know your remote control app.....	2
Flight Tutorial Video	4
User Manual	5
Disclaimer.....	6
Laws and regulations.....	6
Safety Precautions.....	6
Product configuration.....	7
Drone part name.....	7
1.propeller installation	8
2.Aircraft lithium battery	8
3. PTZ camera control	9
Names of remote control parts	10
LCD display	10
Remote control battery installation	10
Pre-flight inspection	10
Drone code	10
Remote control dual mode	11
Geomagnetic correction function	11
Drone gyroscope and gimbal level correction	11
Connect with APP (the mobile phone needs to support 5G-WiFi signal function)	11
Mode switch	12
Drone unlocking	12
Basic Flight	12
Flight control method	13
One-click take-off / landing	14
Headless Mode	14
One touch return	14
Signal return.....	14
Low battery return	14
Taking pictures / videos	15
Received Signal Strength Indication	15
Basic parts	15
Don't panic if you encounter a problem	16
Software Instruction Manual	16
Software Installation Instructions	16
1. Install the mobile client.....	16
2. Connect Drone WiFi.....	16
3. Recommended model configuration.....	17
APP function introduction : When the drone is in the following environment, the fixed hover effect is poor	17
1.1 Introduction to the control interface	18
1.2.1 Function Description.....	18
1.2.2 Function Description.....	18
1.2.3 Function Description.....	19
* Expansion description	19
1.2.4 Control interface function description	19
1.3 Gesture recognition	20
2.MV Interface Introduction	20

SG908 Quick Start Guide

Learn more about drones before flying

* For details, please refer to the instruction manual.

Please ensure that the drone and remote control batteries are fully charged before the flight.

1. Precautions for using the PTZ camera:

Use note:

- A. Please remove the protective cover from the camera before starting this product.
- B. Do not touch the gimbal camera when starting this product! Because the gimbal is automatically calibrated at the moment of power-on, if you touch it without authorization, it will cause the gimbal to fail to calibrate properly, and the gimbal calibration function may be damaged! Please do not touch the camera while the gimbal is being calibrated when the power is on!

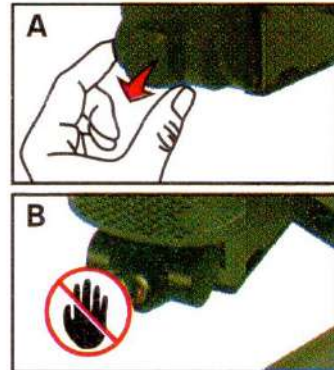

2. Remote control with drone

Turn on the power of the drone first and then the power of the remote control. After the power of the drone remote control is automatically synchronized.

Note: The drone is placed on a flat ground directly in front of the remote control, and the light of the remote control changes from flashing to steady on after the frequency synchronization is successful.

 **important hint:**
You must first correct the geomagnetism and then the gyroscope, otherwise it will affect the normal use.

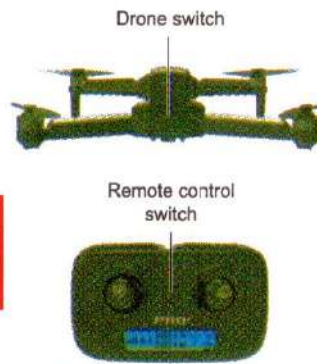

3. Geomagnetic correction

Place the drone on a horizontal surface, press and hold the indicator button (Figure 1) for 5 seconds, and then the remote controller will make a beep to perform geomagnetic correction. At this time, the aircraft lights flash quickly. Pick up the drone and press the indicator clockwise (Figure 2). Rotate 3-5 times, the remote control will make a beep, and then rotate the camera down (Picture 3) 3-5 times, the remote control will make a beep of drone lights flashing slowly, and the lights flashing slowly, the geomagnetic correction is completed!

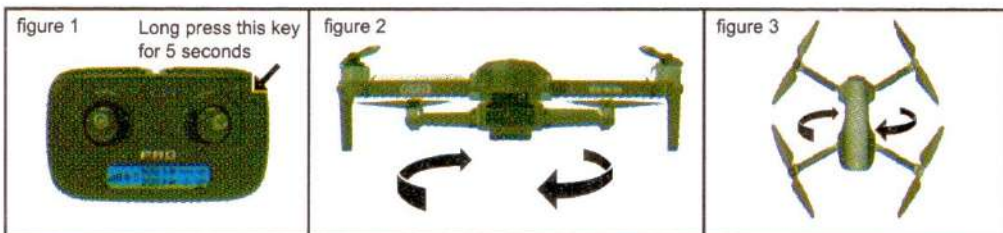

4. Drone gyroscope and gimbal level calibration

Place the drone still on a horizontal surface, and press and hold the remote control for 5 seconds to make a beep. As shown in the figure, the drone light changes from fast flashing to slow flashing.

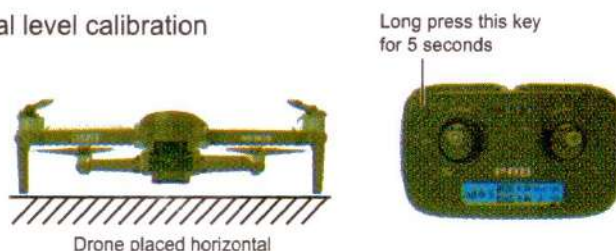

5. Flight mode switch

Note: The default GPS mode (mode 2) of the product is turned on. When the drone does not reach 8 satellites, the drone can only unlock the motor but cannot take off. To take off, you need to switch the optical flow mode before the satellite positioning is completed. Press the record button for 5 seconds (the switching method is shown on the right). After the switch is successful, the remote control will emit a beep. At this time, the drone will not have all GPS-related functions (one-click return, low-power return, uncontrolled return, etc.) Pay attention to the flying height distance to avoid losing the drone!

Note * It is not possible to switch to optical flow mode after GPS positioning is completed. To switch, you need to turn off the drone and remote control and restart.

Long press this key for 5 seconds



6. Drone unlock

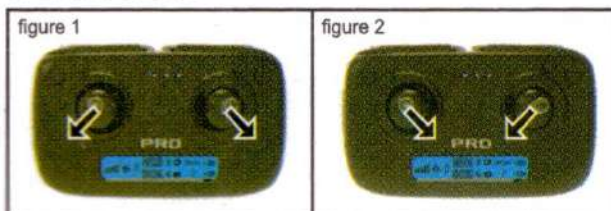

At this time, the throttle stick and the directional stick are pushed to the lower left corner and the lower right corner at the same time (Figure 1), or pushed to the lower right corner and the lower left corner (Figure 2) at the same time, the unlocking can be completed, and the motor can fly after starting.

7. Drone and remote control battery replacement and charging

Drone battery removal method

Press the battery latch and remove the battery backwards. Keep fingers and machine clean and dry before operation, otherwise the battery may not be slipped out.



Remote control battery replacement

Open the battery cover with a screwdriver and install 4 AA batteries.

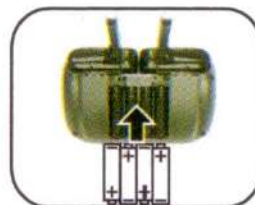

Drone battery charging

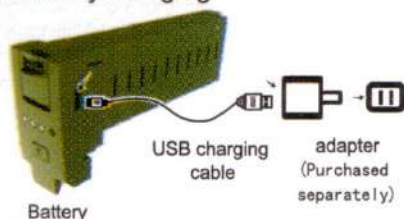

⚠ Tips:

- Insert the plug in the correct way.
- It is recommended to use 5V 1-2A adapter for charging.

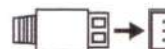

8. Know Your Remote APP

(1) Scan the QR code to download and install the APP, and support Google iOS and Android.



IOS system

Android system

(2) Turn on the power of the drone, find the hotspot of the drone in the mobile phone "Settings-Wireless LAN", click the hotspot network (no password), and the mobile phone will automatically connect.

please click WLAN in the settings of the mobile phone, as shown in the figure below, select the "XL-PRO-5G-*** {serial number}" network and connect, then open the mobile APP to use .



Note: If you need to use the mobile APP to control the aircraft directly, you need to turn off the remote control before using it. The mobile phone is connected to the "XL-PRO-5G-*** {Serial Number}" network and connected, and then you can open the mobile APP use



SG908 Flight Tutorial Video

The default Mode2: GPS / optical flow dual mode when booting. When you enable the Mode2 mode, please pay attention to the use in outdoor open areas without high-rise buildings, high-voltage wires and other signal interference.
Mode1: Optical flow mode. When using this mode, you must turn off the GPS function before taking off.

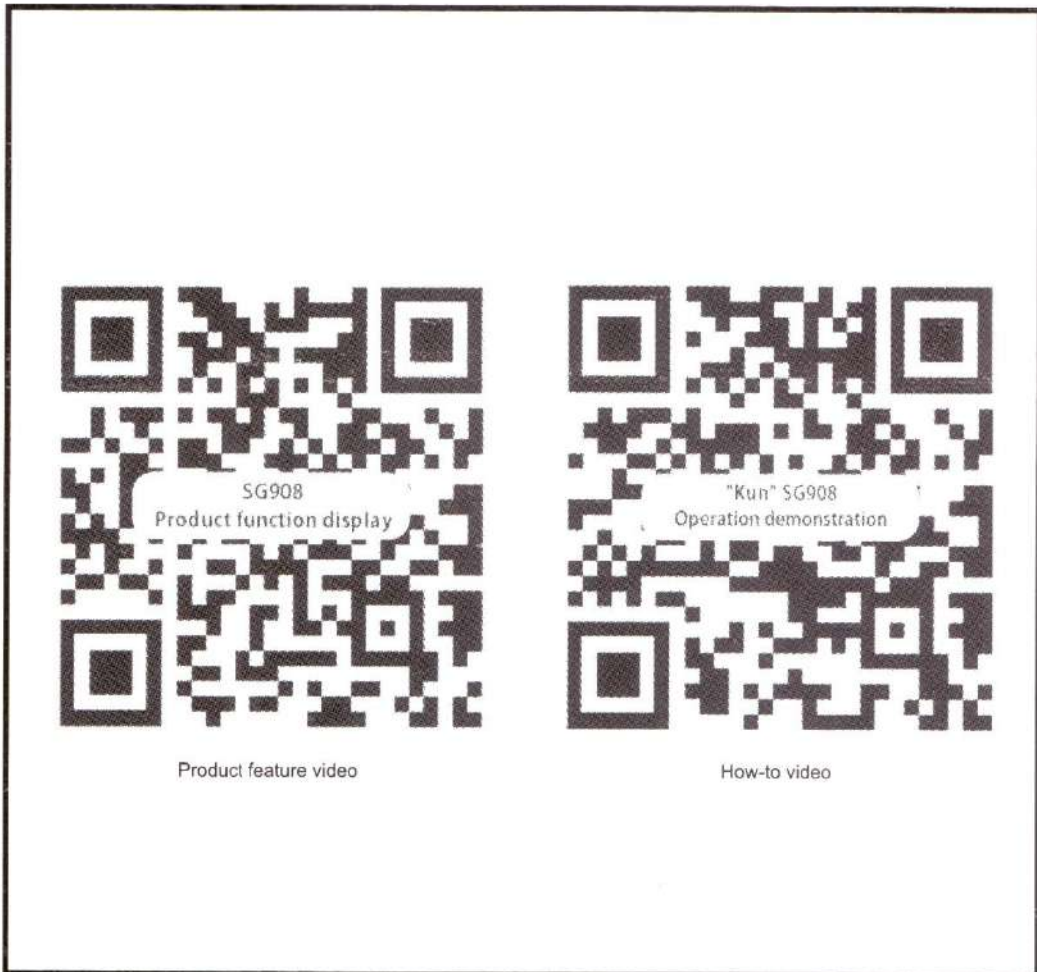

Mode1: Optical flow mode, suitable for open indoors. After the drone and remote control are aligned, and the geomagnetism and gyroscope are corrected, the display on the remote control changes from Mode0 to Mode1. At this time, the drone will automatically perform GPS satellite positioning. , The automatic protection program will not be able to take off, you need to press and hold the video button for 5 seconds, the remote control will make a "drop", which means that the GPS can be unlocked after taking off.

(Note: Mode1 optical flow mode does not have a series of GPS functions such as low-power return, one-click return, etc. Please pay attention to the flight distance and altitude when using)

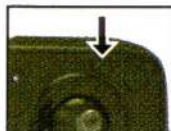

Press and hold the video button for 5 seconds, the remote control will make a "drop", indicating that the GPS function is turned off

Mode2: GPS / optical flow dual mode, suitable for outdoor open areas without signal interference. After the drone and remote control are linked, the geomagnetic and gyroscopes are corrected, the display on the remote control changes from Mode0 to Mode1, at this time the drone GPS satellite search and positioning automatically (Drone search should be placed in an open area when searching for satellites, and there should be no obstructions such as high-rise buildings or cars, high-voltage power lines, or the drone will not be able to complete GPS satellite search and positioning), etc. The number reaches about 10, the positioning is completed, the remote control emits a "dip", and the display frequency of the remote control changes from Mode1 to Mode2 to indicate that the positioning is successful, and the takeoff can be unlocked. (Note: GPS mode does not complete GPS

Before positioning, the drone automatically enables the protection program and cannot take off)



SG908

GPS Smart Drone

User manual

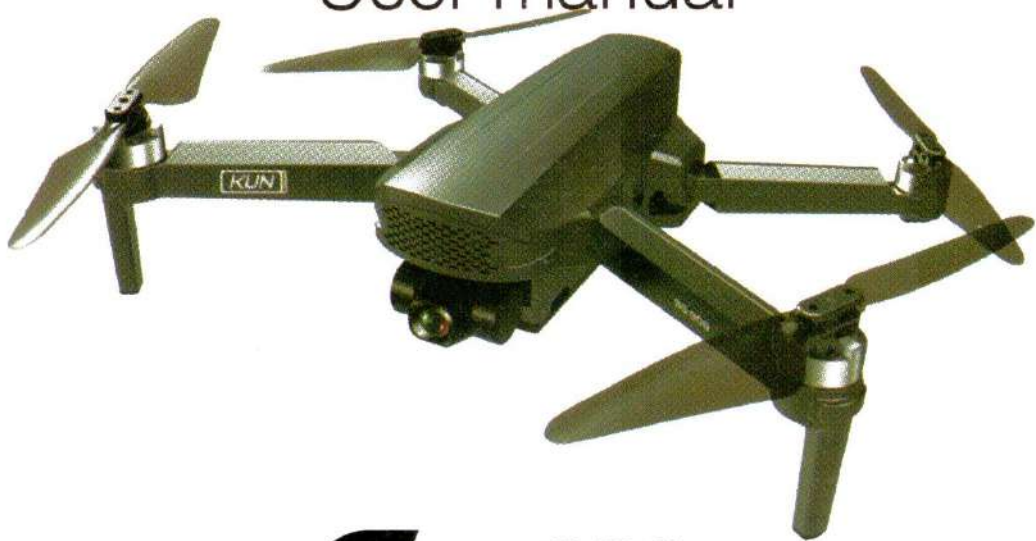

Full HD Image transmission
Farther. Faster. Clearer

(Please confirm that the mobile phone used supports 5G WiFi standard)

GPS



Foldable



GPS
Return Home



Point of
Interest



Way Point
Flight



Intelligent
APP Following



Super long
flight time



Ultra HD
Aerial
Photograph



Three-axis
anti-shake
and
self-stabilizing
gimbal



50 Time
Zooming



Optical flow
positioning

Important notices and safety guidelines

You are welcome to purchase our products. In order to make it easier and more convenient for you to use this drone, please read this manual carefully before operating, and please keep this manual in a safe place for future reference for adjustment and maintenance.

Disclaimer

- This product is not a toy, but a precision device that integrates mechanical, electronic, aerodynamics, high-frequency emission and other professional knowledge into one. It requires correct assembly and debugging to avoid accidents. The product owner must use a safe method to operate the control; improper operation may cause serious personal injury or property damage.
- This product is suitable for people who have experience in operating model drones and are not less than 14 years old.
- If you have any questions about use, operation, maintenance, etc., please contact your local dealer or our company. Our company and the seller are not responsible for any loss and damage caused by improper use or operation and human injury.
- The product contains small parts. Keep it out of the reach of children to avoid the danger of accidental eating or suffocation.

Laws and regulations

To avoid possible injury and loss from illegal activities, the following items must be observed:

- Never fly near a manned aircraft, and land immediately if necessary.
- It is forbidden to use aircraft on the scene of large-scale events. These venues include but are not limited to: sports competition venues and concerts.
- Never fly in areas prohibited by local laws.
- Ensure that the aircraft will not affect the large manned aircraft on the route when flying. Always be vigilant and avoid other aircraft.

Safety Precautions

The remote control model UAV is a high-risk commodity, so keep away from the crowd when flying. Improper assembly or damage to the body, poor electronic control, and unfamiliar operation can all lead to unpredictable accidents such as damage to the drone or personal injury. Operators must pay attention to flight safety and understand all responsibilities for accidents caused by their negligence.

- Keep away from obstacles and people

The remote control drone has uncertain flight speed and status when flying, and there is potential danger. When flying, you must stay away from crowds, high-rise buildings, high-voltage power lines, etc., and avoid flying in bad weather such as wind and rain. The commissioning and installation of the drone must be operated strictly in accordance with the operating instructions. Pay attention to maintaining a distance of 1-2 meters from the user or other people when the drone is flying. And the body, causing injury.

- Keep away from humid environment

The interior of the drone is composed of many precision electronic components and mechanical parts. Therefore, it is necessary to prevent the drone from getting wet or water entering the body, so as to avoid accidents caused by mechanical and electronic component failure. During maintenance, please wipe the surface stain with a clean cloth.

- Avoid manipulation alone

The remote control drone control technique has certain difficulties in the early stages of learning. To avoid flying alone, you need the guidance of experienced people.

- Proper use of this product

Please use our original parts for modification or maintenance to ensure the safety of flight. Please operate and use the product within the scope permitted by the product function, and shall not be used for any illegal purpose other than safety regulations.

- Safe operation

1. Please operate the remote control drone according to your state and flying skills. Fatigue, mental retardation, or improper operation will increase the risk of accidents.

2. Do not use near your ears! Misuse can cause hearing damage.

- Keep away from high-speed rotating parts

When the drone rotor is rotating at high speed, please keep the pilot, surrounding people and objects away from the rotating parts to avoid danger and damage.

- Keep away from heat sources

The remote control drone is composed of metal, fiber, plastic, electronic components and other materials, so it should be kept away from heat sources as much as possible to prevent sunlight, deformation and even damage due to high temperature.

- Environmental requirements

Discard this product at will, which may have an impact on the environment. Please recycle properly in accordance with local laws and regulations.

Product configuration

Packing List

	Drone	x1
	Remote control	x1
	Body battery	x1
	USB charging cable	x1
	screwdriver	x1
	Spare Propeller (2)	x2
	Manual	x1

Drone part names

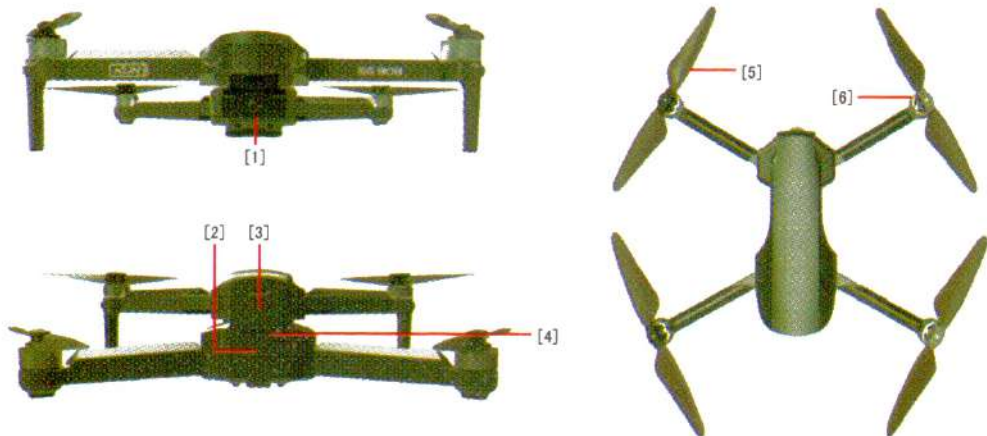

[1] HD camera [2] Power switch [3] Smart lithium battery [4] Power indicator [5] Fan blade [6] Motor

1. Propeller installation

Please make sure that all propellers are installed in the correct orientation as shown in the figure below. If the installation is incorrect, the aircraft will not fly normally.

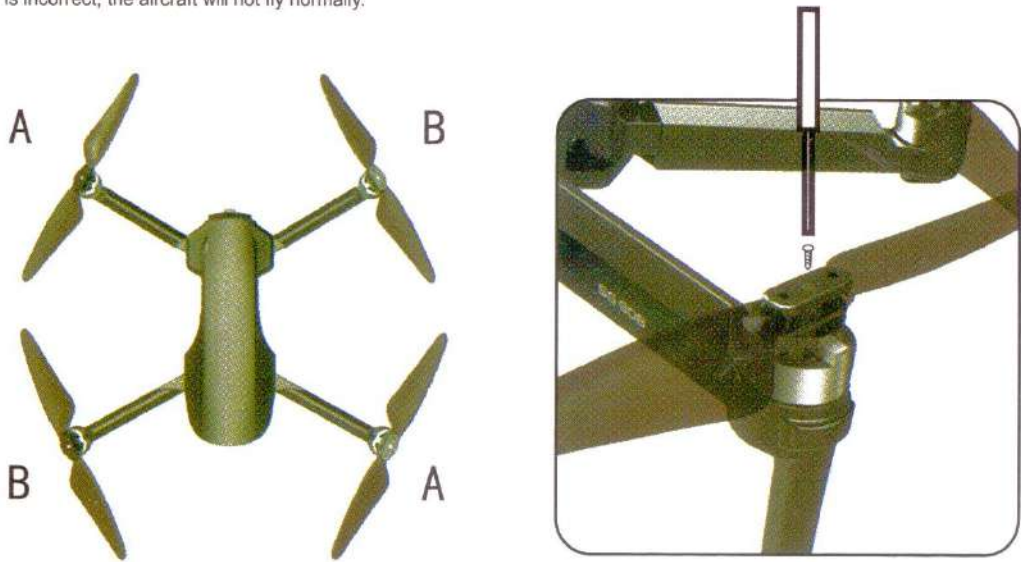

2. Aircraft lithium battery

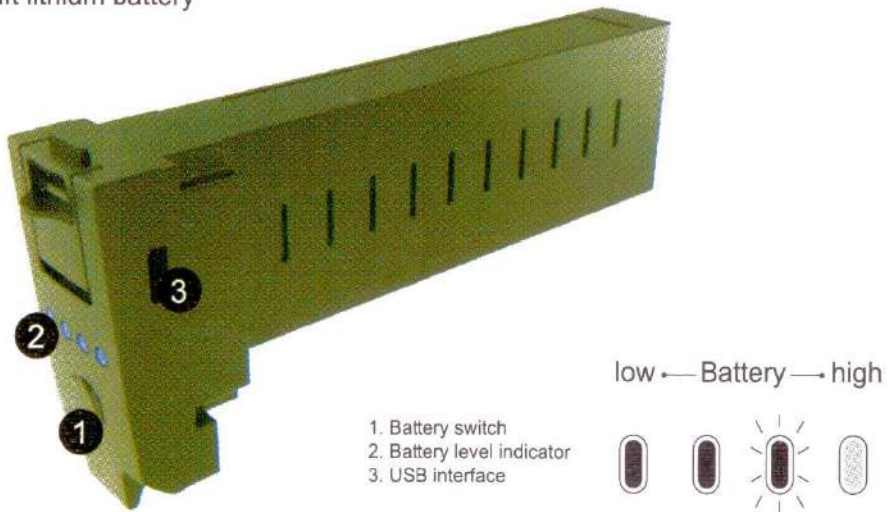

-Press and hold the power button for 3 seconds to turn on, and then press and hold the power button for 3 seconds to turn off.

-Once the battery is in a low power state, and there is 1 light left in the battery indicator, please charge the battery immediately to avoid unnecessary losses.

Battery installation

Press the battery button down, and then push the battery into the drone battery holder. After the installation is complete, the battery clip will pop up and check to ensure that the battery is in place.

⚠ Tips: If the battery is not installed properly, it is likely to cause a drone to interrupt the power supply and fall accident.

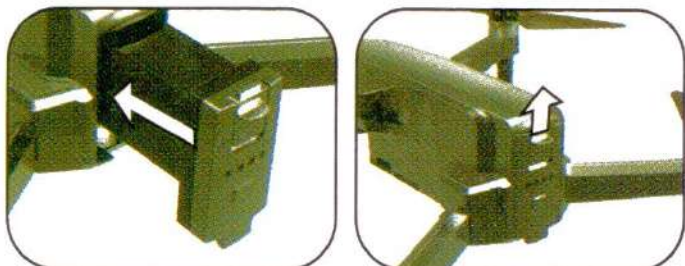

Battery removal

Press the battery latch and remove the battery backwards.
Keep fingers and machine clean and dry before operation, otherwise the battery may not be slipped out.

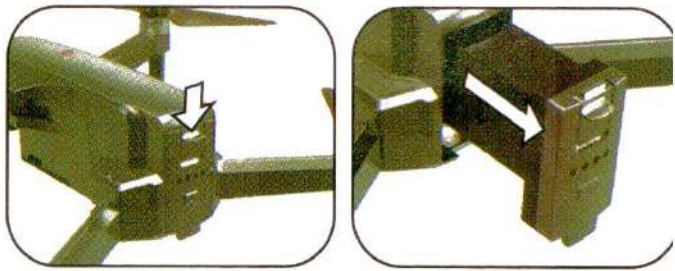

Drone battery charging

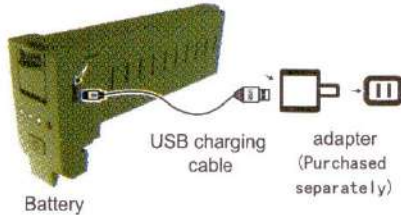

⚠ Tips:

- Insert the plug in the correct way.
- It is recommended to use 5V 1-2A adapter for charging.



- ⚠ • When charging the rechargeable battery, do not use it for children alone. It must be carried out under the supervision of an adult. It must be kept away from flammable materials during charging. The guardian should not leave the aircraft outside the surveillance range during charging.
- Do not short circuit or squeeze the battery to avoid explosion.
- The power supply terminals should not be taken out of the model, and the terminals should not be short-circuited; do not short-circuit, disassemble or throw the battery into fire; do not place the battery in high temperature and heat places (such as in a fire or near an electric heating device).
- The model can only use the recommended charger. Regularly check the charger's wires, plugs, shells and other parts for damage. If you find any damage, stop using it until the repair is complete.
- The charger is not a toy; the charger can only be used indoors.
- The battery must be charged and stored after the flight. If not in use, it is recommended to charge the battery at least once every 3 months to avoid over-discharging the battery and permanently damaging the battery.

⚠ Reminder: The camera needs to be used with the real-time transmission APP. For the download process, please refer to the APP manual, and for the camera function description, please refer to the APP.

3.PTZ camera control

By turning the PTZ button on the remote control, you can adjust the shooting angle of the PTZ camera to 110 ° to experience a better aerial photography process.

When the left button is pressed, the camera is adjusted in the direction of A; when the right button is pressed, the camera is adjusted in the direction of B.

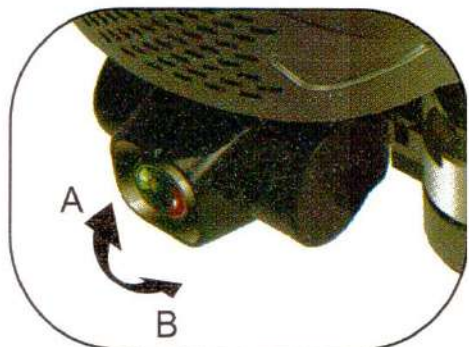
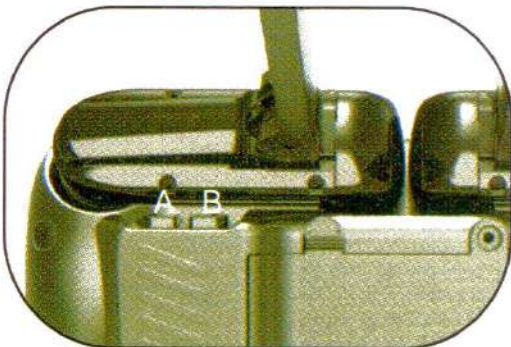

Remote control part names

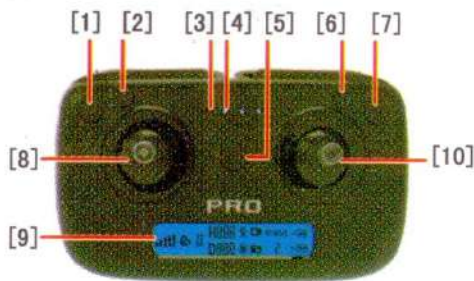

- [1] Speed switch
(Press and hold 5 seconds for gyroscope and gimbal level correction)
- [2] One touch return
- [3] Red signal light (always on when connected)
- [4] battery level indicator (remote control)
- [5] power switch
- [6] Recording button (long press for 5 seconds to turn off mode 2 [GPS mode])
- [7] Photo button (long press for 5 seconds to correct geomagnetism)
- [8] Ascend, descend, turn left, turn right
- [9] LCD display
- [10] Fly Left and Right

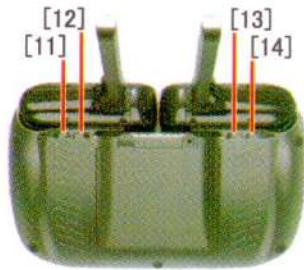

- [11] PTZ up
- [12] PTZ down
- [13] Headless Mode
- [14] Take off and land with one click

LCD display

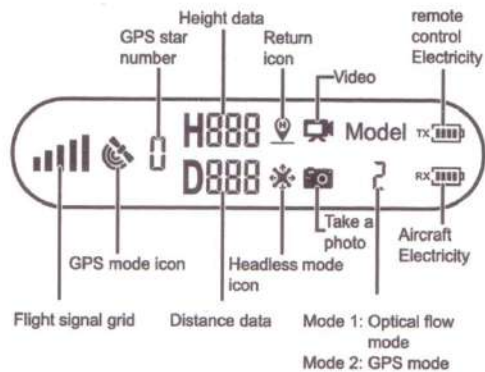

Remote control battery installation

Open the remote control battery cover, insert the 4 AA batteries correctly according to the positive and negative poles indicated by the remote control, and then replace the battery cover.



- ⚠ The remote control uses 4 "AA" non-rechargeable batteries or "AA" rechargeable batteries. (Sold separately)
- Pay attention to battery polarity when installing or replacing batteries.
- Non-rechargeable batteries are not rechargeable. Use only batteries that are the same or the same as the recommended batteries.
- Do not mix old and new or different types of batteries.
- Remove the exhausted batteries in time, and do not throw away used batteries.
- Take out the battery for a long time if not in use to avoid damage to the product caused by battery leakage.

Pre-flight inspection

1. Are the batteries of the remote control and drone sufficient?
2. Whether the blades are installed correctly.
3. Whether the motor starts normally after booting.

Drone pairing

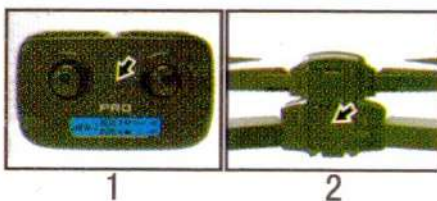

The remote control is turned on and the indicator light flashes. Press and hold the drone battery switch, the battery indicator lights up from left to right, the drone light flashes, the remote control indicator light changes from flashing to long light, and the code is successfully matched.

Remote control dual mode

The default Mode2: GPS / optical flow dual mode when booting. When the Mode2 mode is enabled, it needs to be used outdoors in an open place without signal interference such as high-rise buildings and high-voltage wires.

Mode1: Optical flow mode. When using this mode, you need to turn off the GPS function before taking off.

[Cannot turn off Mode 2 (GPS mode) after GPS positioning]

Geomagnetic correction function

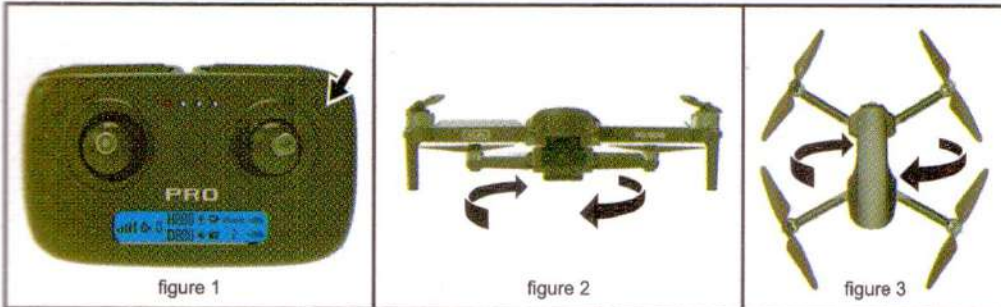

After the drone is successfully linked, press and hold the remote control camera button for about 5 seconds (Figure 1), the remote control will beep once, the drone light will flash quickly, pick up the drone 1 meter from the ground and turn it clockwise 3 (Figure 2), at this time, the remote control drops a beep and the drone is erected, the camera is facing downward (Figure 3), and the clockwise turn of the remote control drops the drone light once every 1 second. can.

Tips: Please make sure that the take-off environment is open, and the satellite signal is greater than 7 stars before take-off.

- Do not perform calibration in areas with strong magnetic fields, such as magnetic deposits, parking lots, construction areas with underground steel bars, etc.
- Do not carry ferromagnetic materials with you during calibration, such as keys and mobile phones.
- Do not calibrate near large pieces of metal.

Drone gyroscope and gimbal level correction



Place the drone still on a horizontal surface, and press and hold the remote control for 5 seconds to make a beep. As shown in the figure, the drone light changes from fast flashing to slow flashing.

Connect with APP (mobile phone needs to support 5G-WiFi signal function)

Turn on the mobile device to scan the QR code on the APP instruction manual and download the APP, then turn on the WIFI function of the mobile device, select "XL-PRO-5G-***" (serial number)" in the WIFI list, and exit the interface. To open the app.

Note: At this time, the remote control is turned off, and the mobile phone app will connect to the drone in about 5 seconds to control the drone. If the drone is not coded with the remote control after it is turned on, after the drone is directly controlled by the mobile phone, the remote control cannot be coded with the drone.

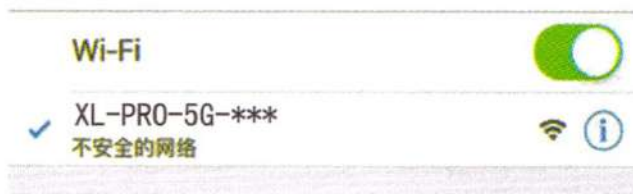

Mode switch

1. Mode 1: [Optical flow mode] It is suitable for indoor open areas. After the drone and remote control are linked, the geomagnetism and gyroscope are corrected, the display on the remote control changes from Mode0 to Mode1, and the drone will automatically perform GPS search satellite positioning, automatic protection program will not be able to take off, you need to press and hold the video button for 5 seconds, the remote control emits a "dip", which means that the GPS can be unlocked after taking off. (Note: Mode1 optical flow mode does not have a series of GPS functions such as low-power return, one-click return, etc. Please pay attention to the flight distance and altitude when using)



2. Mode 2: [GPS / optical flow dual mode] It is suitable for outdoor open areas without signal interference. After the drone and remote control are linked, the geomagnetism and the gyroscope are corrected, the display on the remote control changes from Mode0 to Mode1. UAV automatically performs GPS satellite search and positioning (Drone search is placed in an open area, and there are no high-rise buildings or cars, high-voltage wires and other obstructions around it, otherwise the drone may not be able to complete the GPS satellite search and positioning), When the number of satellites reaches about 10, the positioning is completed, the remote control emits a "drop", the remote control display changes from Mode1 to Mode2 to indicate that the positioning is successful, and you can unlock the takeoff. (Note: Before GPS mode is completed, the drone will automatically take off the protection program and it will not take off)

Drone unlock







At this time, the throttle stick and the directional stick are pushed to the lower left corner and the lower right corner at the same time (Figure 1), or pushed to the lower right corner and the lower left corner (Figure 2) at the same time, the unlocking can be completed and the motor can fly after starting.

Basic flight

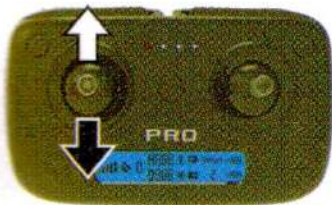
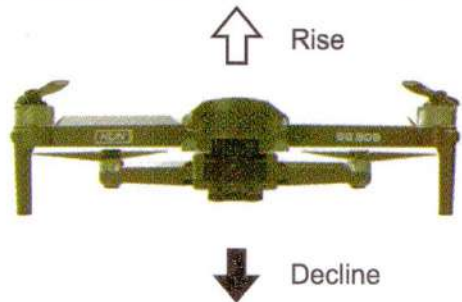
Basic flight steps

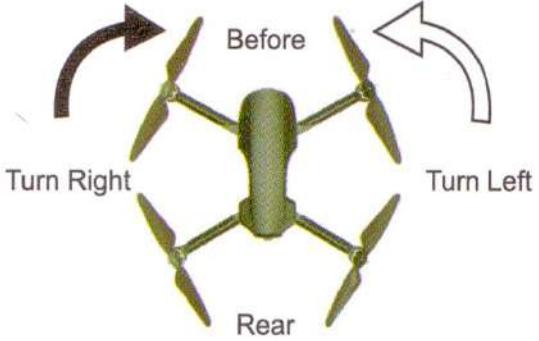
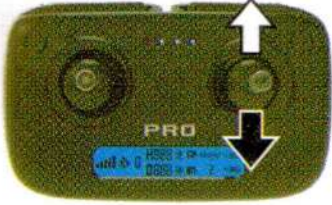
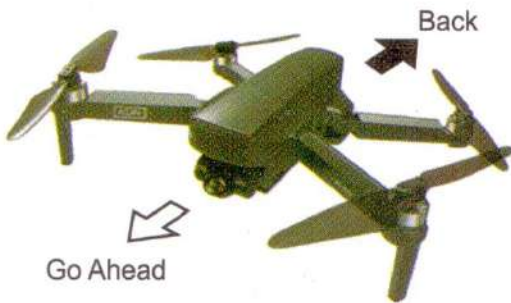
1. Code the remote control with the drone, and the drone completes the initialization.
2. Geomagnetic calibration. (Do not need to calibrate each time at the same location)
3. After the drone gyroscope is detected, unlock the drone.
4. Push the throttle stick up, the drone will take off, and the left / right joystick will control the attitude of the drone.
5. Turn off the power of the drone first, and then turn off the power switch of the remote control.

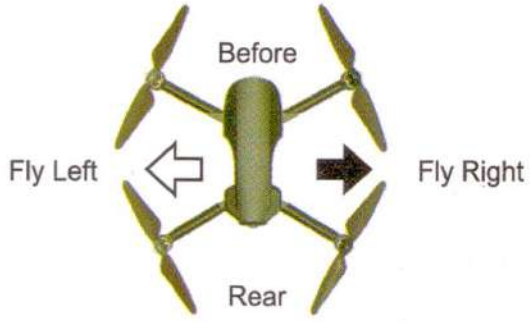
Remote Control	Drone
 <p>A green remote control with two sticks. The left stick has a white arrow pointing up and a black arrow pointing down. The word "PRO" is printed on the device.</p>	 <p>A top-down view of a drone. A white arrow points up with the label "Rise". A black arrow points down with the label "Decline".</p>
 <p>A green remote control with two sticks. The left stick has a white arrow pointing left and a black arrow pointing right. The word "PRO" is printed on the device.</p>	 <p>A top-down view of a drone. A curved black arrow on the left is labeled "Turn Right". A curved white arrow on the right is labeled "Turn Left". The words "Before" and "Rear" are also present.</p>
 <p>A green remote control with two sticks. The right stick has a white arrow pointing up and a black arrow pointing down. The word "PRO" is printed on the device.</p>	 <p>A perspective view of a drone. A white arrow points forward with the label "Go Ahead". A black arrow points backward with the label "Back".</p>
 <p>A green remote control with two sticks. The left stick has a white arrow pointing left and a black arrow pointing right. The word "PRO" is printed on the device.</p>	 <p>A top-down view of a drone. A white arrow on the left is labeled "Fly Left". A black arrow on the right is labeled "Fly Right". The words "Before" and "Rear" are also present.</p>

Flight mode

One-click takeoff / landing

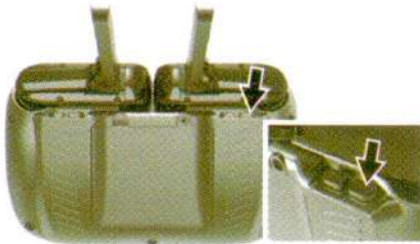

- After the drone is unlocked, press the one-button take-off button briefly, and the drone will automatically take off to hover at a height of about 1.5 meters.
- When the drone is in flight, press the one-button take-off button briefly, and the drone will automatically land on the ground.

Headless mode

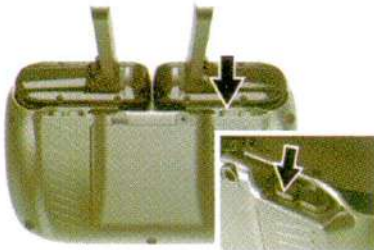

Press the headless mode button, the remote controller will make a "dipping" sound. When the drone is unlocked, the direction pointed by the nose is directly in front of the flight. During the flight, rotate the drone in the direction to direct the flight. When the drone is unlocked, the direction the nose points.

Home Return (Not available in Mode 1 optical flow mode)

The drone has a home function. If the home point is successfully recorded before takeoff, the communication signal between the remote control and the drone is lost or the home key is pressed, the drone will automatically return to the home point and land to prevent accidents.

There are three different ways for drones to return home:

1. One-click return
2. Signal return
3. Low battery return.



Note for return flight:

- During auto return, the drone cannot avoid obstacles.
- When GPS signal is not good or GPS is not working, you cannot return to home.

Home Point: When taking off or during flight, when GPS receives 7 or more stars for the first time, it will record the current position of the drone as the home point.

One-click return



When the GPS signal is good (the number of satellites is greater than 7), you can start the drone home by pressing the one-way home button on the remote control. The home process is the same as the uncontrolled home. Use the stick to control the drone to avoid obstacles. Press the home button again to exit home, and the user can regain control.

Signal return

The GPS signal is good (the number of GPS satellites is greater than 7), the compass is working normally, and after the drone successfully records the home point, if the remote control signal and the APP signal are off for more than 6 seconds, the flight control system will take over the control of the drone. Control the drone to fly back to the signal and stop.

Low battery return

After the drone is low-voltage, the indicator light will flash slowly. At this time, the drone will automatically return to the vicinity of the takeoff point 20 meters. (After the low-power drone returns to the vicinity of the take-off point, the height and distance of the drone will be limited to 20 meters)



Reminder: The drone is in the low-power return mode, and the remote control cannot cancel the return mode.

Photo / Video

Press the remote control "📷" button to take a picture, the remote control LED screen display icon "📷" flashes, press the remote control "📹" button to record, the remote control LED screen display icon "📹" has been slow flashing, then press the "📹" button to exit the recording .



Received signal strength indication

The icon "📶" is the received signal strength indication. The more the number of segments is displayed, the stronger the signal is, and the weaker the signal is.



Product parts

Basic parts

Upper shell	Lower shell	Wind leaf A/B	Silicone pad	Motherboard
Front rocker A	Front rocker B	Rear swing arm A	Rear swing arm B	camera
Gimbal	wifi board	Geomagnetic Module	GPS module	ESC
Charging Cable	remote control	battery		

Don't panic if you encounter problems

No.	problem	Solution
1	Mode 1 The drone motor can rotate, the aircraft cannot take off, the lights flash quickly and slowly	Without turning off the GPS function, the drone has a protection program enabled Press and hold the GPS switch for 5 seconds to turn off the GPS function
2	After the GPS function is turned off in Mode 1, the drone motor can rotate and the drone cannot take off. The lights flash quickly and slowly	Recalibrate the geomagnetism after restart
3	After take-off in Mode 1, the drone keeps blinking and cannot hover.	The ground is too smooth and the environment is too dark, which will cause the optical flow lens to be unstable. Please get a good light and fly in a place where there is no reflection on the ground.
4	After taking off in Mode 2, the drone keeps blinking and cannot hover. It floats around. The remote control always switches between Mode 1 and Mode 2.	GPS positioning is not good, interference is too big, please get open, unobstructed, no high voltage wires
5	Mode 2 The drone motor can rotate, the aircraft cannot take off, the lights flash quickly and slowly	Recalibrate the geomagnetism after restart
6	Drone shakes a lot	The blade is deformed or damaged, it needs to be replaced
7	When the picture is tilted during aerial photography	Land the drone to a flat ground and perform the gimbal level correction again.

Software instruction manual

Software installation instructions

1. Install the mobile client

Please scan the QR code below to download the mobile app to the corresponding website.



IOS system

Android system

2. Connect Drone WiFi

1. Power on the drone;
2. Find the drone hotspot in the phone "Settings-WLAN";
3. Click the hotspot network (no password), and the phone will connect automatically.

Please click WLAN in the settings of the mobile phone, as shown in the figure below, select the "XL-PRO-5G-***" (serial number) network and connect, then open the mobile phone APP to use.



3 Recommended model configuration

1) ios

Configuration	Recommended	Optimal (Support 2 k)
Product model	iPhone 6 and above	iPhone 6 and above
System version	iOS 8.0 and above	iOS 9.0 and above

2) Android

Configuration	Recommended	Optimal(Support 2 k)
The CPU model	Snapdragon 630 and above Samsung Exynos 7420 and above Hair division Helio X25 and above Kirin 950 and above	Snapdragon 835 and above Samsung Exynos 8895 and above Hair division Helio X30 and above Kirin 970 and above
System version	Android 5.0 and above	Android 8.0 and above
Memory size	3G and above	6G and above
CPU usage	Occupancy rate of 25% and below	Occupancy rate of 10% and below

Clean up the background program, which can effectively reduce the CPU usage.

APP function introduction: When the drone is in the following environment, the fixed hover effect is not good.

Note: A drone, at the same time, only one mobile app is allowed to connect!

Note: When the drone is in the following environment, the fixed flow hovering effect of the lower lens is not good, which will make it difficult for the drone to fly smoothly and the camera will shake.



The surface of the water



Dimly lit



Large vertical gap



Smooth reflective ground



Two-color stripe

1.1 Introduction to the Operation Interface



1.2.1 Function Description

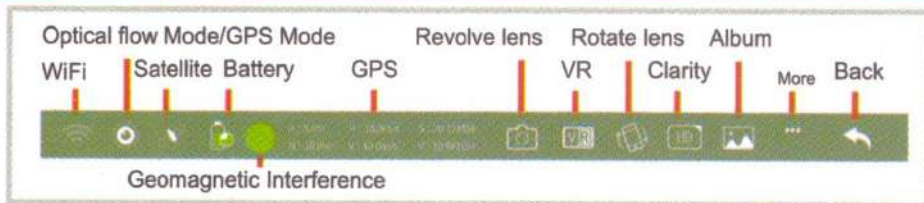

WiFi: Display chart signal strength;

Satellite signals: Represents current flight mode and number of satellites; Scintillation means that the current mode is the optical flow point, without the function of returning, following, circling and pointing. Constant light indicates current GPS mode.

Battery: The battery status of the aircraft.

(1) 2-4 grid indicates the normal power, which can operate the returning, following, circling and pointing flight functions normally in the GPS mode.

(2) 1 grid (flicker state) represents the current low power state, and the aircraft will perform the automatic course reversal function. There is no following, circling and pointing flight function in low power state.

GPS information: Displays the height, distance and corresponding longitude and latitude of the current aircraft from the reentry point.

Geomagnetic interference: Green indicates normal; yellow indicates geomagnetic interference; orange indicates strong geomagnetic interference; red indicates strong geomagnetic interference. When the orange or red icon is displayed, leave the current interference position and recalibrate.

Revolve lens: Can switch between front lens and down lens.

VR model: Click into VR mode.

Rotate lens: Record the relevant parameters of each flight.

Clarity: Click to switch the video definition.

Album: Photos and videos can be viewed.

1.2.2 Function Description

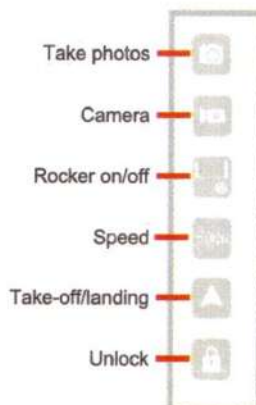

Take photos: Click the button to take photos according to the current lens (front lens or down lens).

Camera: Click the button to shoot videos according to the current lens (front lens or down lens).

Rocker on/off: Click to switch to mobile phone control or remote control.

Speed: Displays the current state of fast and slow. Click to switch to fast and slow in mobile control mode.

Unlock: After unlocking, one key can be used to take off or drop.

Take-off/landing: After the calibration is completed, place the aircraft horizontally and click the unlock button to start the flight operation.

1.2.3 Function Description

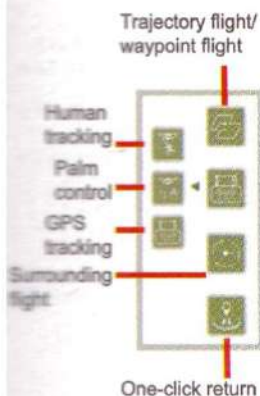

Waypoint flight: In GPS mode, the aircraft will fly according to the location selected on the map.

Trajectory flight: In optical flow mode, the aircraft will fly according to the selected position.

Human tracking: Click the button in the optical flow mode, the aircraft will follow the target person flight. (See the next page for details)

Palm control: Click the button in the optical flow mode, the aircraft will follow the palm up and down. (See the next page for details)

GPS tracking: In GPS mode, click this button and the aircraft will follow the flight.

Surrounding flight: In GPS mode, the aircraft nose will fly around clockwise or counterclockwise with the current position of the aircraft as the center. During the surround process, you can control the rise, fall, forward, and reverse to adjust.

One-click return: In GPS mode, click to achieve one-click return.

* Other Instructions

Human Tracking



(1) Blue candidate boxes for the target person appears on the screen.



(2) On the screen, tap your finger to select the target character.



(3) After the target person is locked, the blue box will turn red. Make sure the red box target character is in the middle of the screen.



(4) The tracking flight starts when the aircraft is about 2m away from the target figure. If the target character is lost, you need to click the target character again.

When the red frame is more than 80% of the human area, the best effect can be achieved.

Palm Control

- (1) facing the camera of the aircraft, lift it horizontally with one hand;
- (2) when the palm is framed by the red square on the App, gently move the palm;
- (3) at this point, the aircraft will follow the palm upward and downward flight;

When the distance between the palm and the camera is about 1m, can obtain the best experience.

1.2.4 Function Description

Holder

After the aircraft takes off, the holder will be displayed on the left side of the screen. At this time, if you move the slider upward, the front lens of the aircraft will move upward by a certain angle; if you move the slider down, the front lens of the aircraft will move downward by a certain angle.

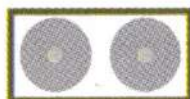

Rocker

The left rocker can control the upward, downward movement, left and right turn of the aircraft, and the right rocker can control the forward, backward movement of the aircraft, and it can also move the aircraft towards the left and right.

share

After clicking  in the upper left corner of the screen on the control page, enter the album interface. When you click to view a photo or video, users can share photos or videos to major social platforms

through  in the top right corner.

1.3 Gesture Recognition

Facing the front lens of the camera, the following gestures can be triggered to trigger the automatic camera or camera function of the aircraft:



Take Photos by Yeah Gestures About 2m in front of the camera of the aircraft, hold the Yeah gesture with one hand flat. After the aircraft successfully recognized the gesture, the countdown of 3 seconds began to take photos;



Shoot Videos by Box Gestures About 2 meters in front of the camera of the aircraft, put your hands on the position of the face jaw to make a square video gesture. After the aircraft has successfully recognized the gesture, the video will start. When the gesture is recognized again, end the recording (the time difference between two recognition should be more than 3 seconds);



Shoot Videos by Palm Gestures About 2 meters in front of the aircraft lens, with five fingers and one hand flat; After the aircraft has successfully recognized the gesture, the video will start. When the gesture is recognized again, end the recording (the time difference between two recognition should be more than 3 seconds);

* Special Instructions

To ensure that the lens gets a higher recognition rate :

1. Please aim the lens face to face;
2. Please fly in a good light environment;
3. Please conduct gesture recognition operation at a distance of about 2m from the lens.

In the following cases, it will result in a low lens recognition rate :

1. Weak light or backlight;
2. The WiFi signal is weak or the signal is disturbed.

2 MV Interface

After clicking the  button in the upper left corner of the screen on the control page, enter the MV interface. In the MV interface, you can shoot music videos.

Rotating picture

Click this button to enable the Rotate Screen feature. At this point, the finger swipes on the screen to rotate the image; if the finger double-clicks anywhere on the screen, the image can be magnified in an instant (this feature also applies when recording video).

Filter Operating lever

Photo album

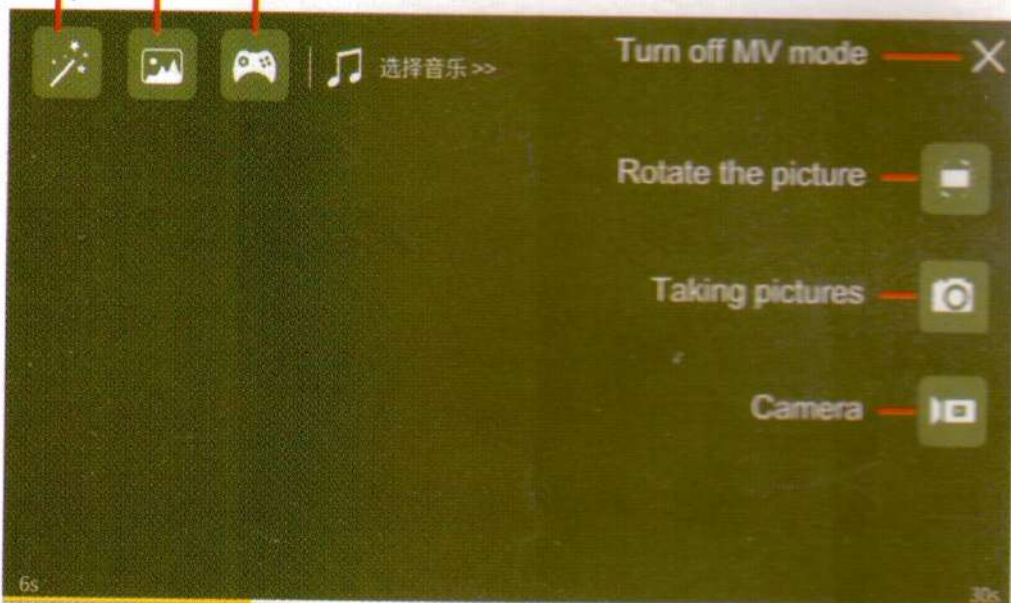

Length of recorded time

Recording progress bar

Length of music time